

2017

MARINE PRICE LIST

EFFECTIVE JANUARY 9, 2017

AIR CONDITIONING & REFRIGERATION

Prices noted are US list prices and are subject to change without notice. This price list supersedes all others.

Mobile living made easy.



TABLE OF CONTENTS

SELF-CONTAINED AIR CONDITIONING PAGE

| | |
|------------------------------------------------------------------------------------|----|
| Dometic Turbo Units (DTU)- Replacements for VTD, STQ, STX units..... | 9 |
| Dometic Compact Units (DCU) - Replacements for VCD, SVCD, SQUF and SXUF units..... | 11 |
| Dometic Low-profile Units (DLU) - Replacements for VLD, SQL and SXL units..... | 11 |
| Dometic EnviroComfort Units (ECD)..... | 12 |
| Cuddy II DC..... | 12 |
| Installation Guide for Cuddy II Kits..... | 13 |



TURBO



COMPACT



LOW-PROFILE



ENVIROCOMFORT



CUDDY II

SPLIT GAS AIR CONDITIONING - CONDENSERS PAGE

| | |
|-----------------------------------------------|----|
| Dometic Emerald Remote Condensing Units (DEU) | |
| * Replacements for ED and EQ units | |
| 115V 60HZ and 230V 60HZ | 14 |
| 220V 50HZ 1PH and 380V 50HZ 3 Phase | 15 |



SPLIT GAS AIR CONDITIONING - EVAPORATORS PAGE

| | |
|-------------------------------------------------------|----|
| TVE Emerald Series TurboVap R-410A Evaporators..... | 16 |
| EBE Series R-410A Evaporators..... | 16 |
| EBLE Low Profile Draw Through R-410A Evaporators..... | 16 |
| EDLE The Breeze Low-profile R-410A Evaporators..... | 16 |
| EBDE Direct Drive R-410A Cooling units..... | 17 |
| EDL The Breeze Low-profile R-417A Evaporators..... | 17 |
| TV TurboVap R-417A Evaporators and Accessories..... | 17 |



TVE/TV



EBE



EBLE



EDLE/EDL

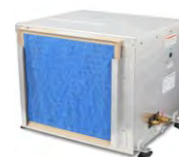

EBDE

LEGACY SPLIT GAS AIR CONDITIONING - CONDENSERS PAGE

| | |
|--------------------------------------------------------------|----|
| MARINE AIR AUTHORIZED DISTRIBUTORS & DEALERS ONLY | |
| CSD Series Condensers..... | 18 |



TABLE OF CONTENTS

LEGACY SPLIT GAS CONDENSERS & EVAPORATORS PAGE

CRUISAIR AUTHORIZED DISTRIBUTORS & DEALERS ONLY

| | |
|--------------------------------------------------------------|----|
| RX & R Series Condensing Units..... | 19 |
| REU Series Evaporators R-417A..... | 20 |
| EBUL Low Profile Draw-Through Series Evaporators R-417A..... | 20 |
| EBS Evaporators..... | 20 |
| RM Series Modulating Condensing Units..... | 20 |
| EHMB Cruisair Modulating Evaporator Units R-417A..... | 20 |
| CoolBreeze Boat Exterior Cooling Kits..... | 20 |



RX/R



REU

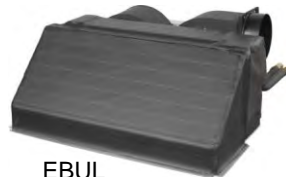

EBUL



EBS



RM



EHMB



CoolBreeze

DOMETIC AIR-COOLED AIR CONDITIONING PAGE

| | |
|--------------------------------------------------------------|----|
| Durasea Rooftop Air Cooled Units..... | 21 |
| JackBoat Air Cooled Unit (SSA)..... | 21 |
| Radome Environmental Control Units (HSA)..... | 21 |
| DuraSea Series Air Cooled Condensers (DCA) Nomenclature..... | 22 |
| DuraSea Condensers (DCA) Base Units and Options..... | 23 |



DURASEA
ROOFTOP



JACKBOAT



RADOME



DURASEA

CHILLED WATER AIR CONDITIONING UNITS PAGE

| | |
|-------------------------------------|----|
| VARC Variable Capacity Chiller..... | 24 |
|-------------------------------------|----|



TABLE OF CONTENTS

CHILLED WATER AIR CONDITIONING UNITS PAGE

CRUISAIR AUTHORIZED DISTRIBUTORS & DEALERS ONLY

| | |
|-------------------------------------------------------------|----|
| MTCGX Cruisair Titanium Modular Tempering Units R-410A..... | 24 |
| MTDX Cruisair Titanium Modular Tempering Units R-410A..... | 24 |
| Unit Bases, Frames and Headers MTDX & TWCX..... | 25 |
| TWCX Cruisair Titanium Modular Chillers R-410A..... | 26 |



MTCGX



MTDX



TWCX

MARINE AIR AUTHORIZED DISTRIBUTORS & DEALERS ONLY

| | |
|---------------------------------------------------------------------|----|
| MCGX Marine Air Titanium Modular Chillers R-410A..... | 27 |
| MCGXLP Marine Air Titanium Low-profile Modular Chillers R-410A..... | 27 |
| MCG Unit Bases and Manifolds..... | 28 |
| CHCG Marine Air Chiller Compact R-410A..... | 28 |



MCGX



MCGXLP



CHCG

CHILLED WATER CONTROL PANELS PAGE

| | |
|-----------------------------------------------------------|----|
| PLC Control Panel Packages..... | 29 |
| PLC Panel Optional Parts..... | 30 |
| STIIC..... | 30 |
| PLC-OTS Electric Boxes - Marine Air Systems Only..... | 30 |
| Single-Unit MPLC Modular Control Panels for Cruisair..... | 31 |
| Additional PLC Control Panel Parts..... | 31 |
| Other Chilled Water Accessories..... | 31 |
| Variable Frequency Drives & AC Line Reactors..... | 32 |

CHILLED WATER AIR HANDLERS PAGE

| | |
|--------------------------------------------------------------|----|
| AU Air Handlers..... | 33 |
| AU-EU (European Version) Air Handlers..... | 35 |
| AT High Velocity & AT36DC Air Handlers..... | 35 |
| ATL Draw-Through Air handlers..... | 36 |
| ABL Horizontal & ATV Vertical Draw-Through Air Handlers..... | 36 |
| Fresh Air Make-up Air Handlers..... | 37 |
| Dometic Air Handler Control Package..... | 37 |
| Air Handler and Blower Orientation Drawing (H3050002)..... | 38 |



AU



AT



ATL



ABL



ATV

TABLE OF CONTENTS

| CLIMATE CONTROLS AND ELECTRONICS | PAGE |
|-------------------------------------------------------------------------|-------------|
| MARINE AIR DISPLAYS - AUTHORIZED DISTRIBUTORS & DEALERS ONLY | |
| Display and Sensor Cables..... | 39 |
| CRUISAIR DISPLAYS - AUTHORIZED DISTRIBUTORS & DEALERS ONLY | |
| Display and Network Cables, Adapters and Temperature Sensors..... | 40 |
| CRUISAIR DISPLAYS - AUTHORIZED DISTRIBUTORS & DEALERS ONLY | |
| Cruisair Q LOGIC Display..... | 42 |
| Cruisair SMX Display..... | 42 |
| Cruisair TWLC Display..... | 42 |
| Cruisair Mechanical Displays..... | 42 |
| CLIMATE CONTROLS AND ELECTRONICS | PAGE |
| MARINE AIR DISPLAYS - AUTHORIZED DISTRIBUTORS & DEALERS ONLY | |
| Marine Air SMART TOUCH Display..... | 43 |
| Marine Air ELITE Display..... | 43 |
| Marine Air PASSPORT I/O Display..... | 43 |
| Marine Air Chilled Water Controls..... | 43 |
| Marine Air Mechanical Controls..... | 43 |
| Marine Air Digital Upgrade Retrofit Kits..... | 44 |
| DOMETIC DISPLAYS AND ACCESSORIES | |
| Dometic ENVIROCOOL/ENVIROCOMFORT Display..... | 45 |
| Dometic PLC Displays..... | 45 |
| Dometic SMART TOUCH Chilled Water Controls..... | 45 |
| Dometic ESKIMO ICE Display..... | 45 |
| Bezels and Keypad Accessories..... | 45 |
| PUMPS & ACCESSORIES | PAGE |
| New Pump Description Nomenclature..... | 46 |
| Pump Assemblies and Pump Packages..... | 47 |
| Circulated Water Pump Packages..... | 49 |
| Pump Accessories..... | 49 |
| CRUISAIR PUMPS - AUTHORIZED DISTRIBUTORS AND DEALERS ONLY..... | |
| Circulating Loop Components..... | 53 |
| ADD-ONS AND SPECIALTY UNITS | PAGE |
| Breathe Easy Air Purifier..... | 54 |
| Whisper Fan Controller..... | 54 |
| Sound Covers..... | 54 |
| Single Phase Smartstart Devices..... | 54 |
| Pilot House Defroster..... | 54 |
| CRUISAIR SYSTEMS ONLY - Auxiliary Duct Heaters..... | 54 |
| Pilot House Defroster Sign Off..... | 55 |
| Auxiliary Heaters - Chill Chasers..... | 56 |

TABLE OF CONTENTS

| A/C ACCESSORIES | PAGE |
|-----------------------------------------|-------------|
| Air Filters..... | 57 |
| Grilles..... | 58 |
| Flexible Air Duct..... | 62 |
| Transition Boxes..... | 63 |
| Plastic T's and Y's..... | 64 |
| Mount Rings..... | 66 |
| Plastic Aluminum Rings and T-Boxes..... | 67 |
| Custom Plenum Request Form..... | 68 |
| Installation Components..... | 69 |

REPLACEMENT PARTS SECTION

| DX EXPLODED DRAWINGS & TABLES | PAGE |
|--------------------------------------------------------|-------------|
| TURBO..... | 70 |
| DCU (VCD-SQUF-SXUF)18-27K..... | 72 |
| ENVIROCOMFORT (ECD/ECM)..... | 74 |
| EMERALD CONDENSER 6-16K..... | 76 |
| EMERALD CONDENSER 24-48K..... | 78 |
| TURBOVAP (TV)..... | 80 |
| EBE/EBHE..... | 82 |
| EBDE..... | 84 |
| FLEX DUCT EVAPORATOR..... | 84 |
| MARINE AIR AUTHORIZED DISTRIBUTORS ONLY | |
| CSD/CSM..... | 85 |
| CRUISAIR AUTHORIZED DISTRIBUTORS ONLY | |
| STOWAWAY SH, SX, SHR, SXR..... | 86 |
| STOWAWAY SXF, SHF and ZEPHYR..... | 87 |
| R TYPE REMOTE CONDENSERS - TABLE ONLY..... | 88 |
| RM TYPE REMOTE MODULATING CONDENSERS - TABLE ONLY..... | 89 |

| DX REPLACEMENT PARTS INDEX | PAGE |
|-----------------------------------|-------------|
| Accumulators..... | 90 |
| Base Valves..... | 90 |
| Blowers..... | 90 |
| Capacitors..... | 91 |
| Compressors..... | 93 |
| Condensers..... | 96 |
| Contactors..... | 97 |
| Control & Control Kits..... | 97 |
| Drain Pans..... | 98 |
| Duct & Install Kits for ECD..... | 98 |
| Electrical Box Assemblies..... | 98 |
| Evaporator Coil Assemblies..... | 98 |

TABLE OF CONTENTS

| DX REPLACEMENT PARTS INDEX | PAGE |
|--------------------------------------------------------------------|-------------|
| Filter Driers and Fuses..... | 99 |
| Heaters and Overloads..... | 100 |
| Pressure Switches/Tee Assemblies..... | 101 |
| Receiver for Emeralds and CS Remotes..... | 102 |
| Relays, Resistors, Reversing Valves..... | 102 |
| Solenoid Coil, Start Assist, Strainer with Cap Tube, TX Valve..... | 103 |

| CW EXPLODED DRAWINGS & TABLES | PAGE |
|------------------------------------------|-------------|
| AU/AU-EU AIR HANDLERS..... | 104 |
| ATL AIRHANDLERS..... | 106 |

| CHILLED WATER REPLACEMENT PARTS INDEX | PAGE |
|----------------------------------------------------------|-------------|
| Adapters, Air handler Parts, Auxiliary Heater Parts..... | 108 |
| Blowers..... | 109 |
| Capacitor - Blower..... | 110 |
| Contactors, Controls And Control Kits..... | 110 |
| Current Transducers..... | 110 |
| CWMC-OTS Electric Boxes..... | 111 |
| Harness..... | 111 |
| Hydromatic Service Sensors..... | 111 |
| Indicator Light..... | 111 |
| Mechanical 3-Knob Thermostats And Parts..... | 111 |
| Power Supplies..... | 111 |
| Pressure Relief Valve..... | 111 |
| Switches..... | 112 |
| Time Delays, Temperature Sensors and Transformers..... | 112 |

| CONDARIA CHILLED WATER PARTS | PAGE |
|----------------------------------------------|-------------|
| Condaria Chilled Water Spare Parts List..... | 113 |

REFRIGERATION SECTION

| GRUNERT REFRIGERATION SYSTEMS | PAGE |
|----------------------------------------------|-------------|
| PassageMaker..... | 116 |
| Holdover Plates & Thermostats..... | 117 |
| Valves, Pumps and Additional Components..... | 118 |
| Parts..... | 119 |
| Evaporator Plate Custom Worksheet..... | 120 |

| KRA REFRIGERATION UNITS | PAGE |
|--------------------------------|-------------|
| KRA Condensing Units..... | 121 |
| Evaporator Tubes..... | 121 |
| Suction and Liquid Lines..... | 121 |
| Accessories & Parts..... | 122 |

TABLE OF CONTENTS

ADLER BARBOUR PAGE

| | |
|----------------------------------------------------|-----|
| Condensing Units and Evaporators..... | 123 |
| Kits and Accessories..... | 124 |
| Custom Evaporator Worksheets VD-150, VD-152, | 125 |

ESKIMO ICE PAGE

| | |
|---------------------------------------------|-----|
| EI1000 and EI540 Titanium Units..... | 127 |
| Replacement Parts for EI1000 and EI540..... | 127 |
| Replacement Parts for EI600..... | 128 |

GALLEY PRODUCTS

REFRIGERATORS AND FREEZERS PAGE

| | |
|------------------------------------------------------------|-----|
| Eskimo Cup Cooler, CRX Refrigerator/Freezer | 129 |
| CRD Drawer Refrigerator/Freezer, Flanges (CRX/CR/CRD)..... | 130 |
| CD Drawer Refrigerators and Flanges..... | 130 |
| CB Built-In Top Load Refrigerators/Freezers..... | 131 |
| CF Portable Refrigerators..... | 131 |
| Power Supplies..... | 131 |
| Replacement Parts for CR and CF units..... | 131 |
| Replacement Parts for R series units..... | 133 |

ORIGO STOVE SERIES PAGE

| | |
|--------------------------------------------|-----|
| Alcohol Stoves, Ovens and Accessories..... | 134 |
|--------------------------------------------|-----|

PRODUCT CANCELLATION POLICY PAGE

| | |
|---------------------------------------------------|-----|
| Dometic Marine's Product Cancellation Policy..... | 135 |
|---------------------------------------------------|-----|

Note:

- 1) Due to a manufacturing facility change, part numbers listed in this book are subject to change without notice. Please contact your sales, applications, or service representative if you should have any questions.
- 2) Dometic sells a large number of items for dealers, distributors, boat builders, and for international distribution. There are many customer-specific items which are not included in this price list. If you need an item, and can't find it in this list, ask your distributor, dealer or one of the sales staff at Dometic, it may still be available.
- 3) If you have a time critical situation, please tell us. We will do our best to facilitate your needs. Please do not request SAME DAY SERVICE unless absolutely necessary.



Due to the EPA mandated phase out of R22 refrigerant, the cost of certain mechanical components used in R417A products has been rising significantly. Also in some cases, these components are no longer available. Therefore the price of these products will likely be increased during 2015 and availability may be an issue. THEREFORE WE RECOMMEND CHECKING PRICE AND AVAILABILITY OF R417A PRODUCTS BEFORE PLACING AN ORDER.

Self-Contained Air Conditioning

Dometic Turbo Units (DTU) are direct replacements for all VT and ST units.

All Units include inside temperature sensor. Display cable NOT included.

115V 60HZ Units

| NEW DOMETIC P/N | New Description | LIST PRICE (USD) | Replaces Cruisair & Marine Air P/N | Old Description |
|-----------------|----------------------|------------------|-------------------------------------|--------------------------------------------------------------------------------------|
| 205160060 | DTU6 115V 60HZ 410A | \$2,260.00 | 205561250 205561255 205561200 | STQ6-410A 115V 60HZ ONLY STX6-410A 115V 60HZ ONLY VTD6K-410A 115V 60HZ ONLY |
| 205160080 | DTU8 115V 60HZ 410A | \$2,420.00 | 205561350 205561355 205561300 | STQ8-410A 115V 60HZ ONLY STX8-410A 115V 60HZ ONLY VTD8K-410A 115V 60HZ ONLY |
| 205160100 | DTU10 115V 60HZ 410A | \$2,645.00 | 205561450 205561455 205561400 | STQ10-410A 115V 60HZ ONLY STX10-410A 115V 60HZ ONLY VTD10K-410A 115V 60HZ ONLY |
| 205160120 | DTU12 115V 60HZ 410A | \$2,725.00 | 205561550 205561555 205561500 | STQ12-410A 115V 60HZ ONLY STX12-410A 115V 60HZ ONLY VTD12K-410A 115V 60HZ ONLY |
| 205160160 | DTU16 115V 60HZ 410A | \$2,855.00 | 205561750 205561755 205561700 | STQ16-410A 115V 60HZ ONLY STX16-410A 115V 60HZ ONLY VTD16K-410A 115V 60HZ ONLY |

115V 60HZ Turbo Units with Smart Start

| | | | | |
|-----------|-------------------------------|------------|-------------------------------------|-------------------------------------------------------------------------------------------------|
| 205160063 | DTU6 115V 60HZ 410A SMRTSTRT | \$2,680.00 | 205561203 | VTD6K-410A 115V SMRTSTART |
| 205160083 | DTU8 115V 60HZ 410A SMRTSTRT | \$2,840.00 | 205561352 205561303 | STQ8-410A 115V 60HZ SMRTSTRT VTD8K-410A 115V 60HZ W/SMRTST |
| 205160103 | DTU10 115V 60HZ 410A SMRTSTRT | \$3,065.00 | 205561452 205561403 | STQ10-410A 115V SMRTSTRT-ONBX VTD10K-410A 115V SMRTSTART |
| 205160123 | DTU12 115V 60HZ 410A SMRTSTRT | \$3,145.00 | 205561552 205561556 205561503 | STQ12-410A 115V SMRTSTRT-ONBX STX12-410A 115V 60HZ SMRTSTRT VTD12K-410A 115V SMRTSTART |
| 205160163 | DTU16 115V 60HZ 410A SMRTSTRT | \$3,275.00 | 205561753 205561756 205561705 | STQ16-410A 115V SMRTSTRT-ONBX STX16-410A 115V 60HZ SMRTSTRT VTD16K-410A 115V 60HZ SMRTSTR |

220V 50HZ Turbo Units with Hose Adapter

| | | | | |
|-----------|--------------------------|------------|-------------------------------------|-----------------------------------------------------------------------------------------------|
| 205161061 | DTU6 220V 50HZ 410A 4MR | \$2,490.00 | 205562201 205562251 | VTD6KZ50-410A AS 4"MR 220V/5 STQ6CK-410A 4"MR 220V/50HZ |
| 205161081 | DTU8 220V 50HZ 410A 5MR | \$2,630.00 | 205562301 205562351 | VTD8KZ50-410A 7"AS 5MR 220/50 STQ8CK-410A 5MR 220V 50HZ |
| 205161101 | DTU10 220V 50HZ 410A 6MR | \$2,825.00 | 205562401 205562451 205562402 | VTD10KZ50-410A 7"AS 6MR 220/5 STQ10CK-410A 6"MR 220V 50HZ VTD10KZ50-410A 6"MR 220V 50HZ |
| 205161121 | DTU12 220V 50HZ 410A 6MR | \$2,925.00 | 205562551 205562501 | STQ12CK-410A 6MR 220V 50HZ VTD12KZ50-410A 7"AS 6MR 220/5 |
| 205161161 | DTU16 220V 50HZ 410A 7MR | \$3,235.00 | 205562701 205562751 205562756 | VTD16KZ50-410A 7"AS 7"MR 220V/ STQ16CK-410A 7"MR 220V 50HZ STX16CK-410A 7"MR 220V 50HZ |

Self-Contained Air Conditioning

| 230V 60HZ Turbo Units | | | | |
|------------------------------------------------|-------------------------------|-------------------------------------------|-----------------------------------------------|--------------------------------------------------------------------------|
| NEW DOMETIC P/N | New Description | LIST PRICE (USD) | Replaces Cruisair & Marine Air P/N | Old Description |
| 205162060 | DTU6 230V 60HZ 410A | \$2,365.00 | 205563250 205563255 205563200 | STQ6C-410A 230V 60HZ STX6C-410A 230V 60HZ VTD6KZ-410A 230V 60HZ |
| 205162080 | DTU8 230V 60HZ 410A | \$2,450.00 | 205563350 205563355 205563300 | STQ8C-410A 230V 60HZ STX8C-410A 230V 60HZ VTD8KZ-410A 230V 60HZ |
| 205162100 | DTU10 230V 60HZ 410A | \$2,660.00 | 205563450 205563455 205563400 | STQ10C-410A 230V 60HZ STX10C-410A 230V 60HZ VTD10KZ-410A 230V 60HZ |
| 205162120 | DTU12 230V 60HZ 410A | \$2,740.00 | 205563550 205563555 205563500 | STQ12C-410A 230V 60HZ STX12C-410A 230V 60HZ VTD12KZ-410A 230V 60HZ |
| 205162160 | DTU16 230V 60HZ 410A | \$2,885.00 | 205563750 205563755 205563700 | STQ16C-410A 230V 60HZ STX16C-410A 230V 60HZ VTD16KZ-410A 230V 60HZ |
| 230V 60HZ Turbo Units with Hose Adapter | | | | |
| 205162061 | DTU6 230V 60HZ 410A 4MR | \$2,490.00 | 205563202 | VTD6KZ-410A 7"AS 4"MR 230V 60H |
| 205162081 | DTU8 230V 60HZ 410A 5MR | \$2,575.00 | 205563301 205563351 | VTD8KZ-410A AS 5"MR 230V/60 STQ8C-410A 5"MR 230V 60HZ |
| 205162101 | DTU10 230V 60HZ 410A 6MR | \$2,785.00 | 205563401 205563451 | VTD10KZ-410A 6"MR 230V/60 STQ10C-410A 6"MR 230V 60HZ |
| 205162121 | DTU12 230V 60HZ 410A 6MR | \$2,865.00 | 205563552 205563501 | STQ12C-410A 6"MR 230V 60HZ VTD12KZ-410A AS 6"MR 230V/6 |
| 205162161 | DTU16 230V 60HZ 410A 7MR | \$3,010.00 | 205563702 205563753 | VTD16KZ-410A AS 7"MR 230/60 STQ16C-410A 7"MR 230V 60HZ |
| 230/220V Turbo Units with Smart Start | | | | |
| 205162123 | DTU12 230V 60HZ 410A SMRTSTRT | \$3,160.00 | 205563503 | VTD12KZ-410A 230V SMRTSTART |
| 205162163 | DTU16 230V 60HZ 410A SMRTSTRT | \$3,305.00 | 205563760 205563703 | STQ16C-410A 230V SMRTSTRT-ONBX VTD16KZ-410A 230V 60HZ SMRTST |
| 205161123 | DTU12 220V 50HZ 410A SMRTSTRT | \$3,245.00 | 205562503 | VTD12KZ50-410A SMRTSTART |
| 205161163 | DTU16 220V 50HZ 410A SMRTSTRT | \$3,530.00 | 205562703 | VTD16KZ50-410A SMRTSTART |
| Aluminum RA Plenums for Turbo Units | | | | |
| Item No. | List Price USD | Description | | |
| 229801121 | \$150.00 | Plenum ALM RA TURBO 6/8K No Ring | | |
| 229801129 | \$255.00 | Plenum ALM RA TURBO 6/8K 10"MR | | |
| 229801093 | \$160.00 | Plenum ALM RA TURBO 10/12K No Ring | | |
| 229801094 | \$255.00 | Plenum ALM RA TURBO 10/12K 12"MR | | |
| 229801257 | \$200.00 | Plenum ALM RA TURBO 14/16K No Cut/No Ring | | |
| 229801124 | \$175.00 | Plenum ALM RA TURBO 14/16K No Ring | | |
| 229801095 | \$270.00 | Plenum ALM RA TURBO 14/16K 12"MR | | |

Self-Contained Air Conditioning

Dometic Compact Units (DCU) are direct replacements for all SQUF, SXUF, VCD and SVCD units. All units include stainless steel drain pan, mounted elec. box and 5' temp sensor.

| NEW DOMETIC P/N | New Description | LIST PRICE (USD) | Replaces Cruisair & Marine Air P/N | Old Description |
|-----------------|-------------------------------------------|------------------|--------------------------------------------------|------------------------------------------------------------------------------------------------------------------------|
| 205600818 | DCU18K 115V 60HZ 410A | \$3,765.00 | 205511700 205410020 205410005 205410006 | SQUF18-HV-410A RTBX 115V 60HZ SXUF18-HV 410A RMTBX 60HZ ONLY VCD18K-HV-410A 115V SVCD18K-HV-410A 115V |
| 205600820 | DCU18K 220V 50HZ 410A 7"MR | \$3,965.00 | 205410018 205410032 205410030 205410029 | SQUF18CK-HV 410A RMBX 220V 50 SXUF18CK/1-HV 410A RMTBX 220V 50 VCD18KZ50-HV-410A 220V SVCD18KZ50-HV-410A 220V |
| 205600803 | DCU27K 220V 50HZ 410A 8"MR | \$5,085.00 | 205410016 205410015 205410070 | SQUF27CK-HV 410A RTBX 220V 50 VCD27SZ50-HV-410A 220V 50HZ SXUF27CK-HV 410A RMTBX 220V 50 |
| 205600873 | DCU30K 220V 50HZ 410A HRST HRZ/OP 6"MR | \$6,450.00 | 205511931 | SVCD30SZ50/1-HV 410A 6"MR 220 |
| 205600819 | DCU18K 230V 60HZ 410A | \$3,765.00 | 205511702 205410034 205410010 205410009 | SQUF18C-HV-410A RMTBX 230V SXUF18C-HV-410A RMTBX 230V VCD18KZ-HV-410A 230V SVCD18KZ-HV-410A 230V |
| 205600827 | DCU27K 230V 60HZ 410A | \$4,845.00 | 205511800 205410036 205410000 205511806 | SQUF27C-HV-410A RMTBX 230V SXUF27C-HV 410A RMTBX 230V VCD27SZ/1-HV 410A 230V SVCD27SZ/1-HV 410A 230V |
| 205600830 | DCU30K 230V 60HZ 410A HRST HRZ/OP 6"MR | \$5,810.00 | 205511930 | SVCD30SZ/1-HV 410A 6"MR 230V |

VIBRATION ISOLATION KITS

| Item Number | List Price (USD) | Description |
|---------------------------|------------------|---------------------------------|
| 293013215 | \$140.00 | KIT DCU18 VIB ISO 35LB |
| 293013216 | \$155.00 | KIT DCU18 VIB ISO 45LB |
| MOUNT RING FOR 27K | | |
| 228701034 | \$42.00 | Ring ABS Trans 8" Inside Flange |

Dometic Low Profile Units (DLU) are direct replacements for all SQL, SXL, & VLD units

| NEW DOMETIC P/N | New Description | LIST PRICE (USD) | Replaces Cruisair & Marine Air P/N | Old Description |
|-----------------|-----------------------|------------------|-------------------------------------|---------------------------------------------------------------------------------------------|
| 205600601 | DLU16K 115V 60HZ 410A | \$ 3,810.00 | 205511600 205511601 205410003 | SQL16 410A LOW PROFILE 115V SXL16K LOW PROFILE 410A 115V VLD16K-410A LOW PROFILE 115V |
| 205600603 | DLU16K 220V 50HZ 410A | \$ 4,005.00 | 205410022 205511604 205510833 | SQL16CK 410A LP 220V/50HZ SXL16CK-410A LOW PROFILE VLD16KZ50-410A LOW PROFIL 220 |
| 205600602 | DLU16K 230V 60HZ 410A | \$ 3,805.00 | 205410012 205511605 205410013 | SQL16C 410A LOW PROFILE 230V SXL16C-410A LOW PROFILE VLD16KZ-410A LOW PROFILE 230V |

Dometic Low-Profile Plenums & Transition Ring

| Item Number | List Price (USD) | Description |
|-------------|------------------|-------------------------------------|
| 229000005 | \$340.00 | Plenum ALM 5" Rect@2 Side Discharge |
| 229000006 | \$260.00 | Plenum ALM 5" OBX2 Up Flow |
| 229000007 | \$260.00 | Plenum ALM 5" OBX2 Down Flow |
| 228700089 | \$37.00 | Ring ABS Trans 5" OB Short Flange |

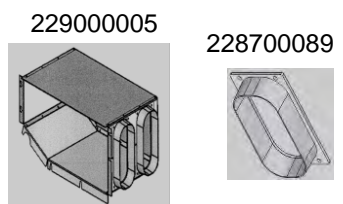

Self-Contained Air Conditioning

| EnviroComfort Self Contained Units, R410A | | |
|-------------------------------------------------------------|------------------|--------------------------------------|
| Item Number | List Price (USD) | Description |
| RETROFIT KITS (UNIT AND CONTROL) | | |
| 207500001 | \$2,040.00 | ECD3.5KC/1-HV 134A Kit, 115V 60Hz |
| 207500306 | \$2,050.00 | ECD6K/1-HV 410A KIT, 115V 60Hz |
| 207500310 | \$2,275.00 | ECD10K/1-HV 410A KIT, 115V 60Hz |
| 207500316 | \$2,445.00 | ECD16K/1-HV 410A KIT, 115V 60Hz |
| 207500307 | \$2,205.00 | ECD6KZ/1-HV 410A KIT, 230V 60Hz |
| 207500010 | \$2,355.00 | ECD10KZ/1-HV 410A KIT, 230V 60Hz |
| 207500017 | \$2,475.00 | ECD16KZ/1-HV 410A KIT, 230V 60Hz |
| INSTALLATION KIT (PUMP, GRILLES, DUCT, AND HARDWARE) | | |
| 218000106 | \$1,105.00 | Install Kit 6K for ECD6K/1-HV |
| 218000110 | \$1,160.00 | Install Kit 10K for ECD10K/1-HV |
| 218000116 | \$1,240.00 | Install Kit 16K for ECD16K/1-HV |
| 218000117 | \$1,265.00 | Install Kit 16KZ for ECD16KZ/1-HV |
| DUAL DUCT KIT (For EnviroCool and EnviroComfort) | | |
| 226600094 | \$155.00 | Dual Duct Kit 6K Enviro Units |
| 226600092 | \$155.00 | Dual Duct Kit 10K & 16K Enviro Units |



| Cuddy II | | |
|-----------------------------|------------------|-------------------------------------------------------------|
| Item Number | List Price (USD) | Description |
| CUDDY II (UNIT ONLY) | | |
| 207501012 | \$4,995.00 | CDB3.5K-12VDC 134A 4"MR |
| 218000120 | \$1,540.00 | Installation Kit for CDB3.5K includes pump and OLED Display |
| 222104040 | \$540.00 | OLED Gray 4-wire 12V T-STAT with harness CDB3.5 |
| 222104041 | \$170.00 | LCD White 5-wire 12V T-STAT with harness CDB3.5 |
| 339575 | \$290.00 | Pump 12VDC 1.5GPM Diaphragm |



Self-Contained Air Conditioning

CDB3.5K INSTALLATION KITS

PROPRIETARY NOTE: THE INFORMATION CONTAINED WITHIN THIS DOCUMENT IS THE PROPERTY OF DOMETIC CORPORATION. ANY ATTEMPT TO COPY OR DISTRIBUTE WITHOUT WRITTEN CONSENT FROM DOMETIC CORPORATION SHALL BE CONSIDERED UNLAWFUL AND CAN BE CONTESTED IN A COURT OF LAW.

DUCT KIT INSTALLATION

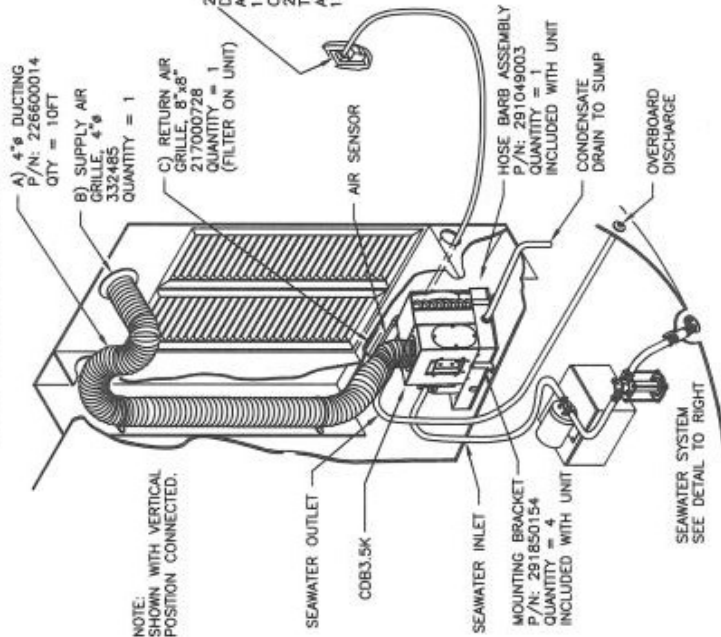

DUCT KIT:

| LEGEND | QTY | P/N | DESCRIPTION |
|--------|------|-----------|----------------------------|
| A | 10FT | 226600014 | DUCTING, INSULATED 4" |
| B | 1 | 332485 | GRILL, SUPPLY, CIRCULAR 4" |
| C | 1 | 217000728 | 8X8TRAF MF PAINTED WHITE |

- INSTALLATION NOTES:
- DO NOT INSTALL AIR CONDITIONER IN BILGE OR ENGINE ROOM AREAS THAT MAY BE EXPOSED TO ENGINE OR GENERATOR EXHAUST FLAMES. A/C UNIT MUST BE SEALED FROM ANY EXHAUST OR BILGE VAPORS.
 - INSTALL RETURN AIR GRILLE LOW AND SUPPLY AIR GRILLE HIGH.
 - SUPPLY AIR GRILLE SHOULD NOT BLOW TOWARD RETURN AIR GRILLE.
 - DUCTING SHOULD BE INSTALLED AS SMOOTH AND TAUT AS POSSIBLE. TRIM ANY EXCESS, AVOID ANY UNNECESSARY BENDS OR LOOPS.

SEAWATER KIT INSTALLATION

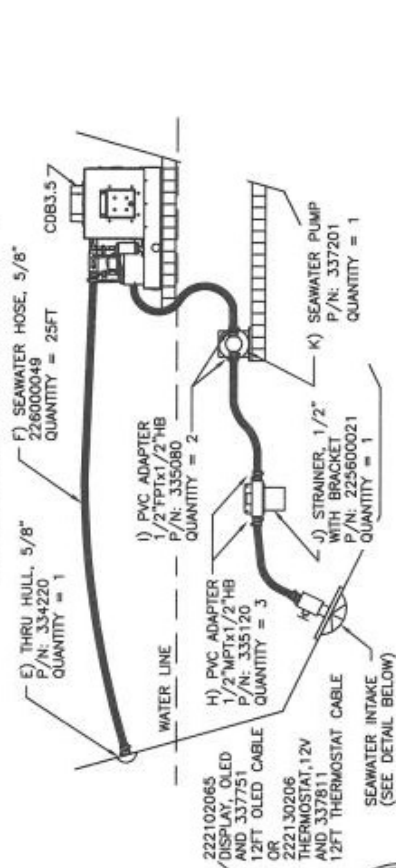

SEAWATER KIT:

| LEGEND | QTY | P/N | DESCRIPTION |
|--------|------|-----------|-----------------------------------|
| E | 1 | 334220 | THRU HULL, 5/8" PLASTIC |
| F | 25FT | 226000049 | HOSE SEAWATER 5/8" |
| H | 3 | 335120 | ADAPT. PVC 1/2" MPTX1/2" HB |
| I | 2 | 335080 | ADAPT. PVC 1/2" FPTX1/2" HB |
| J | 1 | 225600021 | STRAINER W/BRACKET 1/2" FPT |
| K | 1 | 339575 | PUMP, 12VDC 1.5GPM DIAPHRAGM |
| L | 17 | 369617 | CLAMP HOSE #06SS THIN |
| M | 1 | 330482 | BALL VALVE 1/2" SS HNDL (BRONZE) |
| N | 1 | 369699 | STRAINER, SPEED SCOOP 1/2" BRONZE |

L) HOSE CLAMPS: ALL HOSE CONNECTIONS IN SEAWATER SYSTEM TO BE DOUBLE CLAMPED, HOSE CLAMPS TO BE REVERSED AS SHOWN

H) PVC ADAPTER 1/2" MPTX1/2" HB P/N: 335120 QUANTITY = 3

M) BALL VALVE, 1/2" P/N: 330482 QUANTITY = 1

N) SPEED SCOOP, 1/2" P/N: 369699 QUANTITY = 1 (FACING FORWARD)

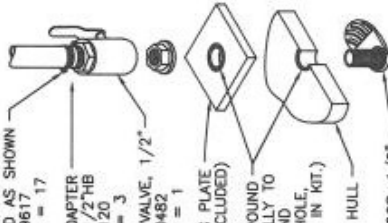

BACKING PLATE (NOT INCLUDED)

BEDDING COMPOUND (APPLY LIBERALLY TO BOTH SIDES AND THROUGHOUT HOLE, NOT INCLUDED IN KIT.)

HULL

N) SPEED SCOOP, 1/2" P/N: 369699 QUANTITY = 1 (FACING FORWARD)

- NOTES:
- SEAWATER SYSTEM MUST HAVE A STEADY UPWARD FLOW FROM INLET TO AIR CONDITIONER.
 - HOSES MUST NOT HAVE KINKS, LOOPS OR HIGH SPOTS WHERE AIR CAN BE TRAPPED.
 - PUMP AND STRAINER MUST BE BELOW WATER LINE AND STRAINER MUST BE BELOW PUMP.
 - SPEED SCOOP SHOULD BE INSTALLED AS FAR BELOW THE WATER LINE AND AS CLOSE TO THE KEEL AS POSSIBLE, FACING FORWARD.
 - AVOID OR MINIMIZE 90° BENDS OR ELBOWS AS MUCH AS POSSIBLE. ROTATE PUMP HEAD TOWARD DIRECTION OF WATER FLOW.
 - ELECTRICAL CONNECTIONS SHOULD BE DONE BY QUALIFIED PERSONNEL ONLY.

| REV | DATE | REVISION DESCRIPTION | DWG | APR |
|-----|------|----------------------|-----|-----|
| | | | | |
| | | | | |
| | | | | |
| | | | | |

| | | |
|----------------|---------------------|-----------------------|
| DOMETIC | | CDB3.5K |
| DATE: 12/12/14 | DWG BY: [Signature] | PART NUMBER: M1030143 |
| SCALE: NTS | APR BY: [Signature] | REV: 01 |

Emerald Split Gas Condensing Units

Dometic Emerald Units, R410A

The DEU units are direct replacements for all ED and EQ units.

| NEW DOMETIC P/N | New Description | LIST PRICE (USD) | Replaces Cruisair & Marine Air P/N | Old Description |
|-----------------------------------|--------------------------|------------------|------------------------------------|--------------------------------------------------------------|
| 115V 60HZ | | | | |
| 201150060 | DEU6 115V 60HZ | \$2,490.00 | 712206100 712106100 | ED6U-410 115V/60/1 EQ6U-410 115V/60/1 |
| 201150080 | DEU8 115V 60HZ | \$2,490.00 | 712208100 712108100 | ED8U-410 115V/60/1 EQ8U-410 115V/60/1 |
| 201150100 | DEU10 115V 60HZ | \$2,655.00 | 712210100 712110100 | ED10U-410 115V/60/1 EQ10U-410 115V/60/1 |
| 201150120 | DEU12 115V 60HZ | \$2,740.00 | 712212100 712112100 | ED12U-410 115V/60/1 EQ12U-410 115V/60/1 |
| 201150160 | DEU16 115V 60HZ | \$2,845.00 | 712216100 712116100 | ED16U-410 115V/60/1 EQ16U-410 115V/60/1 |
| 230V 60HZ | | | | |
| 201152060 | DEU6 230V 60HZ | \$2,490.00 | 712206200 712106200 | ED6-410 230V/60/1 EQ6U-410 230V/60/1 |
| 201152080 | DEU8 230V 60HZ | \$2,490.00 | 712208200 712108200 | ED8U-410 230V/60/1 EQ8U-410 230V/60/1 |
| 201152100 | DEU10 230V 60HZ | \$2,655.00 | 712210200 712110200 | ED10U-410 230V/60/1 EQ10U-410 230V/60/1 |
| 201152120 | DEU12 230V 60HZ | \$2,740.00 | 712212200 712112200 | ED12U-410 230V/60/1 EQ12U-410 230V/60/1 |
| 201152160 | DEU16 230V 60HZ | \$2,845.00 | 712216200 712116200 | ED16U-410 230V/60/1 EQ16U-410 230V/60/1 |
| 201152240 | DEU24 230V 60HZ | \$3,990.00 | 712224200 712124200 | ED24U-410 230V/60/1 EQ24U-410 230V/60/1 |
| 201152300 | DEU30 230V 60HZ | \$4,465.00 | 712230200 712130200 | ED30U-410 230V/60/1 EQ30U-410 230V/60/1 |
| 201152360 | DEU36 230V 60HZ | \$4,770.00 | 712236200 712136200 | ED36U-410 230V/60/1 EQ36U-410 230V/60/1 |
| 201152480 | DEU48 230V 60HZ | \$5,400.00 | 712248200 712148200 | ED48-410 230V/60/1 EQ48U-410 230V/60/1 |
| 230V 60HZ with Smart Start | | | | |
| 201152123 | DEU12 230V 60HZ SMRTSTRT | \$3,190.00 | 712212202 | ED12U-410 230V/60/1 SMRTSTRT |
| 201152163 | DEU16 230V 60HZ SMRTSTRT | \$3,295.00 | 712216203 | ED16U-410 230V/60/1 SMRTSTRT |
| 201152243 | DEU24 230V 60HZ SMRTSTRT | \$4,440.00 | 712224201 712124203 | ED24U-410 230V/60/1 SMRTSTRT EQ24-410 230V/60/1 SMRTSTRT |
| 201152303 | DEU30 230V 60HZ SMRTSTRT | \$4,930.00 | 712230201 712130202 | ED30U-410 230V/60/1 SMRTSTRT EQ30U-410 230V/60/1 SMRTSTRT |
| 201152363 | DEU36 230V 60HZ SMRTSTRT | \$5,240.00 | 712236201 712136201 | ED36U-410 230V/60/1 SMRTSTRT EQ36U-410 230V/60/1 SMRTSTRT |
| 201152483 | DEU48 230V 60HZ SMRTSTRT | \$5,850.00 | 712248203 712148201 | ED48-410 230V/60/1 SMRTSTRT EQ48-410 230V/60/1 SMRTSTRT |

Emerald Split Gas Condensing Units

Dometic Emerald Units, R410A

The DEU units are direct replacements for all ED and EQ units.

| NEW DOMETIC P/N | New Description | LIST PRICE (USD) | Replaces Cruisair & Marine Air P/N | Old Description |
|-----------------------------------|--------------------------|------------------|------------------------------------|-----------------------------------------------------|
| 220V 50HZ | | | | |
| 201151060 | DEU6 220V 50HZ | \$2,550.00 | 712206300 712106300 | ED6-410 220V/50/1 EQ6-410 220V/50/1 |
| 201151080 | DEU8 220V 50HZ | \$2,550.00 | 712208300 712108300 | ED8-410 220V/50/1 EQ8-410 220V/50/1 |
| 201151100 | DEU10 220V 50HZ | \$2,720.00 | 712210300 712110300 | ED10-410 220V/50/1 EQ10-410 220V/50/1 |
| 201151120 | DEU12 220V 50HZ | \$2,800.00 | 712212300 712112300 | ED12-410 220V/50/1 EQ12-410 220V/50/1 |
| 201151160 | DEU16 220V 50HZ | \$3,020.00 | 712216300 712116300 | ED16-410 220V/50/1 EQ16-410 220V/50/1 |
| 201151240 | DEU24 220V 50HZ | \$4,065.00 | 712224300 712124300 | ED24-410 220V/50/1 EQ24-410 220V/50/1 |
| 201151300 | DEU30 220V 50HZ | \$4,570.00 | 712230300 712130300 | ED30-410 220V/50/1 EQ30-410 220V/50/1 |
| 201151360 | DEU36 220V 50HZ | \$4,880.00 | 712236300 712136300 | ED36-410 220V/50/1 PASSPORT EQ36-410 220V/50/1 |
| 201151480 | DEU48 220V 50HZ | \$5,400.00 | 712248300 712148300 | ED48-410 220V/50/1 PASSPORT EQ48-410 220V/50/1 |
| 201151600 | DEU60 220V 50HZ | \$6,615.00 | 712260300 712160300 | ED60-410 220V/50/1 PASSPORT EQ60-410 220V/50/1 |
| 201151720 | DEU72 220V 50HZ | \$7,415.00 | 712172300 | EQ72-410 220V/50/1 Q-LOGIC |
| 220V 50HZ with Smart Start | | | | |
| 201151121 | DEU12 220V 50HZ SMRTSTRT | \$3,250.00 | 712212301 | ED12-410 220V/50/1 SMRTSTRT |
| 201151163 | DEU16 220V 50HZ SMRTSTRT | \$3,470.00 | 712216301 | ED16-410 220V/50/1 SMRTSTRT |
| 201151243 | DEU24 220V 50HZ SMRTSTRT | \$4,515.00 | 712224301 | ED24-410 220V/50/1 SMRTSTRT |
| 201151303 | DEU30 220V 50HZ SMRTSTRT | \$5,040.00 | 712230301 | ED30-410 240V/50/1 SMRTSTRT |
| 201151363 | DEU36 220V 50HZ SMRTSTRT | \$5,350.00 | 712236301 | ED36-410 220V/50/1 SMRTSTRT |
| 201151483 | DEU48 220V 50HZ SMRTSTRT | \$5,850.00 | 712248302 | ED48-410 220V/50/1 SMRTSTRT |
| 380V 50HZ 3 PHASE | | | | |
| 201153243 | DEU24 380V 50HZ 3 PHASE | \$4,250.00 | 712224600 712124600 | ED24-410 380V/50/3 PASSPORT EQ24U-410 380V/50/3 |
| 201153303 | DEU30 380V 50HZ 3 PHASE | \$4,975.00 | 712230600 | ED30-410 380V/50/3 PASSPORT |
| 201153363 | DEU36 380V 50HZ 3 PHASE | \$5,215.00 | 712236600 712136600 | ED36-410 380V/50/3 PASSPORT EQ36U-410 380V/50/3 |
| 201153483 | DEU48 380V 50HZ 3 PHASE | \$6,035.00 | 712248600 712148600 | ED48U-410 380V/50/3 EQ48-410 380V/50/3 Q-LOGIC |
| 201153603 | DEU60 380V 50HZ 3 PHASE | \$6,915.00 | 712160600 | EQ60U-410 380V/50/3 |
| 201153723 | DEU72 380V 50HZ 3 PHASE | \$7,715.00 | 712272500 712172600 | ED72-410 380V/50/3 I/O PSPRT EQ72U-410 380V/50/3 |

Split Gas Evaporators

Emerald Series TurboVap Units, R410A

| Item Number | List Price (USD) | Description |
|-------------|------------------|-------------------|
| 215612000 | \$1,075.00 | TVE4, R410A 115V |
| 215612100 | \$1,075.00 | TVE6, R410A 115V |
| 215612200 | \$1,075.00 | TVE8, R410A 115V |
| 215612300 | \$1,125.00 | TVE10, R410A 115V |
| 215612400 | \$1,155.00 | TVE12, R410A 115V |
| 215612500 | \$1,230.00 | TVE16, R410A 115V |
| 215613000 | \$1,075.00 | TVE4, R410A 230V |
| 215613100 | \$1,075.00 | TVE6, R410A 230V |
| 215613200 | \$1,075.00 | TVE8, R410A 230V |
| 215613300 | \$1,125.00 | TVE10, R410A 230V |
| 215613400 | \$1,155.00 | TVE12, R410A 230V |
| 215613500 | \$1,230.00 | TVE16, R410A 230V |



Emerald Series TurboVap Units, R410A w/Hose Adapter

| | | |
|-----------|------------|------------------------|
| 215613005 | \$1,105.00 | TVE4, R410A 4"MR 230V |
| 215613105 | \$1,105.00 | TVE6, R410A 5"MR 230V |
| 215613205 | \$1,105.00 | TVE8, R410A 5"MR 230V |
| 215613305 | \$1,155.00 | TVE10, R410A 6"MR 230V |
| 215613405 | \$1,185.00 | TVE12, R410A 6"MR 230V |
| 215613505 | \$1,260.00 | TVE16, R410A 7"MR 230V |

Note: TVE units also available with right hand configuration. Call for part number and pricing.

EBE Series Evaporator Units, R410A

| Item Number | List Price (USD) | Description |
|-------------|------------------|---------------------|
| 215400518 | \$2,565.00 | EBE18-230V, 50/60Hz |
| 215400524 | \$2,925.00 | EBE24-230V, 50/60Hz |
| 215400530 | \$3,140.00 | EBE30-230V, 50/60Hz |
| 215400536 | \$3,360.00 | EBE36-230V, 50/60Hz |



***Note:** EBE and EBLE also available in some models with electric heat. Call for availability and pricing.

EBLE Low Profile Draw-Through Series Evaporator Units, R410A

| Item Number | List Price (USD) | Description |
|-------------|------------------|---------------------------|
| 215400412 | \$2,620.00 | EBLE12-230V, 2 HV Blowers |
| 215400415 | \$2,730.00 | EBLE16-115V, 2 HV Blowers |
| 215400416 | \$2,730.00 | EBLE16-230V, 2 HV Blowers |
| 215400424 | \$3,235.00 | EBLE24-230V, 2 HV Blowers |
| 215400430 | \$3,500.00 | EBLE30-230V, 2 HV Blowers |
| 215400436 | \$3,740.00 | EBLE36-230V, 2 HV Blowers |

EBLE Units with Plenum Installed

| | | |
|-----------|------------|-------------------------------------|
| 215400417 | \$3,210.00 | EBLEP16-230V, with Plenum |
| 215400425 | \$3,655.00 | EBLEP24-230V, with Plenum |
| 215400431 | \$4,105.00 | EBLEP30-230V, with Plenum, 1/2" Ins |
| 215400437 | \$4,280.00 | EBLEP36-230V, with Plenum |



EDLE The Breeze Low Profile Evaporator Units, R410A

| Item Number | List Price (USD) | Description |
|-------------|------------------|----------------------------------|
| 215400316 | \$2,375.00 | EDLE16-230V, Low Profile Evap |
| 215400319 | \$2,645.00 | EDLE16-QD 230V, Low Profile Evap |



Split Gas Evaporators

| EBDE Direct-Drive Cooling Units, R410A | | |  |
|-----------------------------------------------|------------------|----------------------------------|-------------------------------------------------------------------------------------|
| Item Number | List Price (USD) | Description | |
| 215400636 | \$4,150.00 | EBDE36V-230V, Vertical Discharge | |
| 215400648 | \$4,280.00 | EBDE48V-230V, Vertical Discharge | |
| 215400660 | \$4,730.00 | EBDE60V-230V, Vertical Discharge | |
| 215400673 | \$4,970.00 | EBDE72V-220V, Vertical Discharge | |

***Note: EBDE also available in additional sizes. Call for availability and pricing.**

| EDL The Breeze Low Profile Evaporator Units, R417A | | |  |
|-----------------------------------------------------------|------------------|-------------------------------|-------------------------------------------------------------------------------------|
| Item Number | List Price (USD) | Description | |
| 215311770 | \$2,225.00 | EDL16, Low Profile Evap 115V | |
| 215311870 | \$2,425.00 | EDL16C, Low Profile Evap 230V | |

| TurboVap Units, R417A | | |  |
|------------------------------|------------------|---------------------|--------------------------------------------------------------------------------------|
| Item Number | List Price (USD) | Description | |
| 215412000 | \$1,300.00 | TV4, R-417A , 115V | |
| 215412100 | \$1,300.00 | TV6, R-417A , 115V | |
| 215412200 | \$1,300.00 | TV8, R-417A , 115V | |
| 215412300 | \$1,350.00 | TV10, R-417A , 115V | |
| 215412400 | \$1,380.00 | TV12, R-417A , 115V | |
| 215412500 | \$1,480.00 | TV16, R-417A , 115V | |
| 215413000 | \$1,300.00 | TV4, R-417A , 230V | |
| 215413100 | \$1,300.00 | TV6, R-417A , 230V | |
| 215413200 | \$1,300.00 | TV8, R-417A , 230V | |
| 215413300 | \$1,350.00 | TV10, R-417A , 230V | |
| 215413400 | \$1,380.00 | TV12, R-417A , 230V | |
| 215413500 | \$1,480.00 | TV16, R-417A , 230V | |

Note: TV units also available with right hand configuration. Call for part number and pricing.

Accessories for TurboVap Units

| Tube Extensions for TurboVaps | | |
|-----------------------------------------------|----------------|-------------------------------------------------------|
| Item No. | List Price USD | Description |
| 221300318 | \$230.00 | 3' 1/4 x 3/8 ins fl2 (TurboVap 4-12K) |
| 221300319 | \$240.00 | 3' 3/8 x 1/2 ins fl2 (TurboVap 16K) |
| Aluminum RA Plenums for TurboVap Units | | |
| 229801627 | \$130.00 | Plenum ALM RA TV4K 8" Ring |
| 229801520 | \$140.00 | Plenum ALM RA TV6/8K 10" Ring |
| 229000038 | \$175.00 | Plenum ALM RA TV10/12K 12" Ring |
| 229000034 | \$180.00 | Plenum ALM RA TV16K 12" Ring |
| Refrigerant Distribution Manifolds | | |
| 238100038 | \$325.00 | SD8-6(3) Suction Distributor 1/2 IN X (3) 3/8 OUT |
| 238100047 | \$410.00 | SD12-8, Suction Distributor 3/4" IN X (5) 1/2" |
| 238100048 | \$290.00 | DD4, Discharge Distributor 3/8" IN X (5) 1/4" OUT |
| 238100037 | \$320.00 | DD6-4(3) Discharge Distributor 3/8" IN X (3) 1/4" OUT |

Legacy Split Gas Condensers

Marine Air Authorized Distributors Only

| CSD Condensing Unit (6-48K), R417A | | |
|-------------------------------------------|-------------------------|-----------------------------|
| Item Number | List Price (USD) | Description |
| 206411100 | \$3,350.00 | CSD6UK/1 417A 115V 60HZ |
| 206411200 | \$3,210.00 | CSD9UK 417A 115V 60HZ |
| 206411300 | \$3,310.00 | CSD12UK/1 417A 115V 60HZ |
| 206411400 | \$3,425.00 | CSD16UK/1 417A 115V 60HZ |
| 201411100 | \$3,350.00 | CSD6UKZ/1 417A 230V 60HZ |
| 201411200 | \$3,210.00 | CSD9UKZ/1 417A 230V 60HZ |
| 201411300 | \$3,310.00 | CSD12UKZ/1 417A 230V 60HZ |
| 201411400 | \$3,425.00 | CSD16UKZ/1 417A 230V 60HZ |
| 201411500 | \$5,100.00 | CSD24URZ/1 417A 230V 60HZ |
| 201411600 | \$5,620.00 | CSD30URZ/1 417A 230V 60HZ |
| 201411700 | \$6,225.00 | CSD36URZ/1-417A 230V 60HZ |
| 201411800 | \$6,810.00 | CSD48URZ/1-417A 230V 60HZ |
| 201411150 | Call For Price | CSD6UKZ50/1-417A 220V 50HZ |
| 201411250 | Call For Price | CSD9UKZ50/1-417A 220V 50HZ |
| 201411350 | \$3,380.00 | CSD12UKZ50/1 417A 220V 50HZ |
| 201411450 | \$3,630.00 | CSD16UKZ50/1 417A 220V 50HZ |
| 201411550 | \$5,180.00 | CSD24URZ50/1 417A 220V 50HZ |
| 201411650 | \$5,865.00 | CSD30URZ50/1 417A 220V 50HZ |
| 201411750 | Call For Price | CSD36URZ50/1-417A 220V 50HZ |
| 201411850 | \$7,095.00 | CSD48URZ50/1-417A 220V 50HZ |

Condensing units are also available with mechanical control or Smart Start.
Please contact your sales representative for part number and price.



CSD16K



Legacy Split Gas Condensers and Evaporators

Cruisair Authorized Distributors Only

| RX Series Condensing Unit (5-48K), R417A with SMXII Control (Display Not Included) | | |
|-------------------------------------------------------------------------------------------|------------------|------------------------|
| Item Number | List Price (USD) | Description |
| 701307100 | \$3,415.00 | RX7U-417, 115V 60HZ |
| 701310101 | \$3,265.00 | RX10U-417, 115V 60HZ |
| 701312100 | \$3,375.00 | RX12U-417, 115V 60HZ |
| 701316101 | \$3,495.00 | RX16U-417, 115V 60HZ |
| 701307201 | \$3,415.00 | RX7UC-417, 230V/60HZ |
| 701310200 | \$3,265.00 | RX10UC-417, 230V/60HZ |
| 701312201 | \$3,375.00 | RX12UC-417, 230V/60HZ |
| 701316201 | \$3,495.00 | RX16UC-417, 230V/60HZ |
| 701320303 | \$4,815.00 | RX20UC-417, 230V/60HZ |
| 701320306 | \$4,815.00 | RX24UC-417, 230V/60HZ |
| 701330308 | \$5,330.00 | RX30UC-417, 230V/60HZ |
| 701336304 | \$5,815.00 | RX36UC-417, 230V/60HZ |
| 701348307 | \$6,650.00 | RX48UC-417, 230V/60HZ |
| 701307302 | \$3,165.00 | RX7UCK-417, 240V/50HZ |
| 701310301 | \$3,340.00 | RX10UCK-417, 240V/50HZ |
| 701312302 | \$3,435.00 | RX12UCK-417, 240V/50HZ |
| 701316302 | \$3,710.00 | RX16UCK-417, 240V/50HZ |
| 701320305 | \$4,880.00 | RX20UCK-417, 240V/50HZ |
| 701320308 | \$4,880.00 | RX24UCK-417, 240V/50HZ |
| 701330309 | \$5,450.00 | RX30UCK-417, 240V/50HZ |
| 701336303 | \$5,940.00 | RX36UCK-417, 240V/50HZ |
| 701348305 | \$6,865.00 | RX48UCK-417, 240V/50HZ |

Units also available in 380V 50HZ 3 phase



CHECK PRICING AND AVAILABILITY BEFORE PLACING AN ORDER.

| R Series Condensing Units, R417A with Mechanical Control (Not Included) | | |
|--------------------------------------------------------------------------------|------------------|----------------------------|
| Item Number | List Price (USD) | Description |
| 701107100 | \$3,145.00 | R7-417 - 115V/60HZ |
| 701110101 | \$3,020.00 | R10-417 - 115V/60HZ |
| 701112102 | \$3,120.00 | R12-417 - 115V/60HZ |
| 701116102 | \$3,245.00 | R16-417 - 115V/60HZ |
| 701107200 | \$3,145.00 | R7C-417 - 230V/60HZ |
| 701110200 | \$3,020.00 | R10C-417 - 230V/60HZ |
| 701112200 | \$3,120.00 | R12C-417 - 230V/60HZ |
| 701116200 | \$3,265.00 | R16C-417 - 230V/60HZ |
| 701120201 | \$4,560.00 | R20C-417 - 230V/60HZ |
| 701124201 | \$4,845.00 | R24C-417 - 230V/60HZ |
| 701130201 | \$5,085.00 | R30C-417 - 230V/60HZ |
| 701136201 | \$5,560.00 | R36C-417 - 230V/60HZ |
| 701148201 | \$6,430.00 | R48C-417 - 230V/60HZ |
| 701112300 | \$3,190.00 | R12CK-417 - 240V/50HZ |
| 701116300 | \$3,465.00 | R16CK-417 - 240V/50HZ |
| 701024503 | \$5,105.00 | R24DC-417 - 230V/60HZ/3PH |
| 701336305 | \$6,060.00 | R36DC-417 - 230V/60HZ/3PH |
| 701148500 | \$7,315.00 | R48DC-417 - 230V/60HZ/3PH |
| 701136602 | \$6,435.00 | R36E-417 - 460V/60HZ/3PH |
| 701148601 | \$5,940.00 | R48E-417 - 460V/60HZ/3PH |
| 701148801 | \$6,675.00 | R48ECK-417 - 380V/50HZ/3PH |





Legacy Split Gas Condensers and Evaporators

Cruisair Authorized Distributors Only

| RE/REU Series Evaporator Units, R417A | | |  |
|----------------------------------------------|------------------|-----------------------------|-------------------------------------------------------------------------------------|
| Item Number | List Price (USD) | Description | |
| 715012423 | \$2,335.00 | REU20C 230/60/1 | |
| 715012004 | \$2,335.00 | REU20C-7"MR 230/60/1 | |
| 715012404 | \$2,510.00 | REU24C - 230/50-60/1 | |
| 715013003 | \$3,160.00 | REU30C - 230/50-60/1 | |
| 715013601 | \$3,160.00 | RE36C 36K REMOTE EVAP 230/1 | |

| EBUL Low Profile Draw-Through Series Evaporator Units, R417A | | |  |
|---------------------------------------------------------------------|------------------|------------------------------|-------------------------------------------------------------------------------------|
| Item Number | List Price (USD) | Description | |
| 715041603 | \$2,400.00 | EBUL16, 115V, 2 HV Blowers | |
| 715041604 | \$2,510.00 | EBULP16, 115V, 2 HV Blowers | |
| 715041602 | \$2,510.00 | EBULP16C, 230V, 2 HV Blowers | |
| EBUL16C | \$2,400.00 | EBUL16C, 230V, 2 HV Blowers | |
| 715052404 | \$2,965.00 | EBUL24C, 230V, 2 HV Blowers | |
| 715052407 | \$3,070.00 | EBULP24C, 230V, 2 HV Blowers | |
| 715053003 | \$3,520.00 | EBUL30C, 230V, 2 HV Blowers | |
| 715053605 | \$3,520.00 | EBUL36C, 230V, 2 HV Blowers | |

| EBS Evaporators | | |  |
|------------------------|------------------|-------------------------------------|-------------------------------------------------------------------------------------|
| Item Number | List Price (USD) | Description | |
| 715061203 | \$2,320.00 | EBS12 115/60/1 | |
| 715061602 | \$2,320.00 | EBS16S Evap. 115V 3 Speed Motor | |
| 715061603 | \$2,320.00 | EBS16SC Vertical Discharge 230/60/1 | |

| Modulating Condensing Units, R417A | | |  |
|-------------------------------------------|------------------|-----------------------|---------------------------------------------------------------------------------------|
| Item Number | List Price (USD) | Description | |
| 701724201 | \$5,825.00 | RM24C-417 - 230/60/1 | |
| 701330207 | \$5,945.00 | RM30C-417 - 230/60/1 | |
| 701742205 | \$6,555.00 | RM42C-417 - 230/60/1 | |
| 701724202 | \$5,825.00 | RM24CK-417 - 240/50/1 | |
| 701730303 | \$6,320.00 | RM30CK-417 - 240/50/1 | |
| 701742304 | \$7,040.00 | RM42CK-417 - 240/50/1 | |
| 701730501 | \$6,785.00 | RM30DC-417 - 230/60/3 | |
| 701742501 | \$7,275.00 | RM42DC-417 - 230/60/3 | |

| Modulating Evaporator Units (R417A) | | |  |
|--------------------------------------------|------------------|---------------------------|---------------------------------------------------------------------------------------|
| Item Number | List Price (USD) | Description | |
| 715221006 | \$2,670.00 | EHMB6C, 230V, 1KW Heat | |
| 715221009 | \$2,670.00 | EHMB8C, 230V, 1KW Heat | |
| 715221004 | \$2,725.00 | EHMB10C, 230V, 1.5KW Heat | |
| 715221003 | \$2,760.00 | EHMB12C, 230V, 2KW Heat | |
| 715221605 | \$2,760.00 | EHMB16C, 230V, 2KW Heat | |

| Modulating Systems Control | | |
|-----------------------------------|----------|-----------------------------------------------------------|
| 763100037 | \$680.00 | PLHMX-HV, SMX II P/L Box for Modulating Systems, 115/230V |

| CoolBreeze | | |  |
|----------------------------------------------------------------------|------------------|------------------------------------|---------------------------------------------------------------------------------------|
| <i>For cockpit & flybridge areas (call for more information)</i> | | | |
| Item Number | List Price (USD) | Description | |
| 703112251 | \$4,260.00 | RSC12C-417, Cool Only Cond 230V | |
| 715000602 | \$2,020.00 | SCE6C, Evap w/TX Valve 230/60/1*** | |

Dometic Air-Cooled Units

DuraSea Rooftop (Air-Cooled A/C)

| Item Number | List Price (USD) | Description |
|-------------------------------------------------------------------------------|------------------|----------------------------------------------|
| 489516AXX1C0 | \$1,800.00 | Durasea Rooftop, 15K, 115V, Polar White |
| 3107206.017 | \$150.00 | Air Distribution Kit, Polar White |
| 3314998.000 | \$60.00 | Heat Kit Complete, 120V* |
| *Note: The below Air Distribution Kit should be used when using the Heat Kit. | | |
| 3314851.000 | \$135.00 | Air Distribution Kit, Polar White |
| 83341AXX1C0 | \$2,000.00 | Rooftop, 12K, 220V 50HZ, Polar White |
| 3315364.000 | \$175.00 | Heat Kit Complete, 240V, 1.5KW |
| 3314855.000 | \$210.00 | Air Distribution Kit, Universal, Polar White |
| 3309364.002 | \$105.00 | Rooftop Cover Replacement Kit, Polar White |



Jackboat Air-Cooled Unit

| Item Number | List Price (USD) | Description |
|-------------|------------------|------------------------------------|
| 202000601 | \$8,660.00 | SSA16KZ 1.5KW 410A w/ Electric Box |



Radome Units Air-Cooled A/C (for cooling of radar/communication domes)

Call for more information

| Item Number | List Price (USD) | Description |
|-------------------------------------------------------------|------------------|---------------------------------------------------|
| Radome Units Internally Mounted | | |
| 202000409 | \$6,250.00 | HSA16UKC/2 417A 115V |
| 202000404 | \$6,495.00 | HSA16UKC/2 417A 115V with Cord |
| 202000403 | \$6,395.00 | HSA16UKCZ/1-417A 230V |
| 202000402 | \$6,540.00 | HSA16UKCZ/1-417A 230V with Cord |
| 202000406 | \$6,660.00 | HSA16UKCZ50/1-417A 220V/50Hz |
| Radome Units Externally Mounted with Remote Displays | | |
| 202000408 | \$6,405.00 | HSA16UKC/2 417A 115V 5" Duct 20' Display Cable |
| 202000405 | \$6,620.00 | HSA16UKCZ/1-417A 230V 5" Duct 20' Display Cable |
| 202000407 | \$6,670.00 | HSA16UKCZ50/1-417A 220V 5" Duct 20' Display Cable |



Dometic Air-Cooled Units

DURASEA CONDENSING UNIT MODEL NUMBER NOMENCLATURE

DCA036A4663C0AA

DuraSea Condensing Unit

Refrigerant Type

A = R410A
B = R417A

Nominal Tonnage

030 = 2.5 Tons
036 = 3 Tons
048 = 4 Tons
060 = 5 Tons

072 = 6 Tons

090 = 7.5 Tons

120 = 10 Tons

Control Type

A = None -use with 24VAC Thermostat
Q = Unity Control

Voltage

2361 = 230V/60/1
2251 = 220V/50/1
2363 = 208-230V/60/3
4663 = 460V/60/3
4053 = 400V/50/3
3853 = 380V/50/3

Options

A = None

B = Nema 4x electric Box & heat shrunk electric connections

C = Low ambient Fan Cycling Control

D = Phase Monitor

E = Valve Fan Side (VFS) - standard on 7.5/10 ton models

F = Variable Frequency Drive

G = Crankcase Heater

H = Suction Accumulator

I = Reserved for future use

J = Reserved for future use

K = Combination of options B, C, D, G, and H

L = Combination of options B and D

M = Combination of options B, C, and D

N = Combination of options B, C, D and H

P = Combination of options B and G

R = Combination of options B, C, and F

Design Revision

A = Initial Rev

Not Used

0 = Not Used

Coil Options

A = Al Fin/Copper Tube

B = E-Coat Al Fin/Copper Tube

C = Copper Fin/Tube



Dometic Air-Cooled Units

DURASEA CONDENSING UNITS BASE MODELS

410A - Uncoated Aluminum Finned/Copper tube Condenser (Coil Option A)

| <u>Base Size</u> | <u>List Price (USD)</u> | <u>DESCRIPTION</u> |
|------------------|-------------------------|----------------------------|
| DCA036A | \$7,990.00 | DuraSea 36,000 BTU, R410A |
| DCA048A | \$8,190.00 | DuraSea 48,000 BTU, R410A |
| DCA060A | \$9,190.00 | DuraSea 60,000 BTU, R410A |
| DCA072A | \$9,390.00 | DuraSea 72,000 BTU, R410A |
| DCA090A | \$11,590.00 | DuraSea 90,000 BTU, R410A |
| DCA120A | \$12,790.00 | DuraSea 120,000 BTU, R410A |

410A - ElectroFin® E-Coat Aluminum Finned/Copper tube Condenser (Coil Option B)

| <u>Base Size</u> | <u>List Price (USD)</u> | <u>DESCRIPTION</u> |
|------------------|-------------------------|----------------------------|
| DCA036A | \$8,390.00 | DuraSea 36,000 BTU, R410A |
| DCA048A | \$8,590.00 | DuraSea 48,000 BTU, R410A |
| DCA060A | \$9,990.00 | DuraSea 60,000 BTU, R410A |
| DCA072A | \$10,190.00 | DuraSea 72,000 BTU, R410A |
| DCA090A | \$12,790.00 | DuraSea 90,000 BTU, R410A |
| DCA120A | \$13,990.00 | DuraSea 120,000 BTU, R410A |

410A - Copper Finned/Copper Tube Condenser (Coil Option C)

| <u>Base Size</u> | <u>List Price (USD)</u> | <u>DESCRIPTION</u> |
|------------------|-------------------------|----------------------------|
| DCA036A | \$8,990.00 | DuraSea 36,000 BTU, R410A |
| DCA048A | \$9,190.00 | DuraSea 48,000 BTU, R410A |
| DCA060A | \$11,190.00 | DuraSea 60,000 BTU, R410A |
| DCA072A | \$11,390.00 | DuraSea 72,000 BTU, R410A |
| DCA090A | \$14,590.00 | DuraSea 90,000 BTU, R410A |
| DCA120A | \$15,790.00 | DuraSea 120,000 BTU, R410A |

The below options are available as an adder to the base unit list. See previous page for description of options.

| <u>Options and Adders</u> | <u>36K - 48K</u> | <u>60K - 72K</u> | <u>90K - 120K</u> |
|-----------------------------|------------------|------------------|-------------------|
| 380/50HZ units | \$175.00 | \$250.00 | \$300.00 |
| Option B | \$650.00 | \$650.00 | \$650.00 |
| Option C | \$275.00 | \$275.00 | \$275.00 |
| Option D | \$175.00 | \$175.00 | \$175.00 |
| Option E | \$375.00 | \$375.00 | N/A |
| Option F | Call for Price | Call for Price | Call for Price |
| Option G | \$155.00 | \$155.00 | \$155.00 |
| Option H | \$550.00 | \$550.00 | \$800.00 |
| <u>Combinations:</u> | | | |
| Option K | \$1,805.00 | \$1,805.00 | \$2,055.00 |
| Option L | \$825.00 | \$825.00 | \$825.00 |
| Option M | \$1,100.00 | \$1,100.00 | \$1,100.00 |
| Option N | \$1,650.00 | \$1,650.00 | \$1,900.00 |
| Option P | \$805.00 | \$805.00 | \$805.00 |
| Option R | Call for Price | Call for Price | Call for Price |

24VAC Electric Box

| <u>Item Number</u> | <u>List Price (USD)</u> | <u>Description</u> |
|-------------------------------------|-------------------------|-------------------------------------------|
| 203000008 | \$335.00 | Electric Box DCA 24VAC T-STAT |
| 203000011 | \$365.00 | Electric Box DCA 24VAC T-STAT w/Contactor |
| 24VAC Electric Box with Heat | | |
| 203000010 | Call For Price | Electric Box DCA 24VAC TS 1PH Heat |
| 203000009 | Call For Price | Electric Box DCA 24VAC TS 3PH Heat |

Note: Use these transformer boxes when applying DuraSea units along with AHU's that do not include 24VAC transformers.

Chiller Units and Modules

| VARIABLE CAPACITY CHILLER | | | | | |
|---------------------------------------------|------------------|---------------------------|-----------|---------------|-------------|
| Item Number | List Price (USD) | Description | | | |
| 260160001 | \$11,995.00 | VARC48 208-230/50 or 60/1 | | | |
| 260160006 | \$13,995.00 | VARC72 208-230/50 or 60/1 | | | |
| Bases and Manifolds | | | | | |
| Chiller Tons | Manifold Set | Base | Varc Size | Manifold Size | # of Stages |
| 8 | \$2,845.00 | \$1,525.00 | VARC48 | 1.5 | 2 |
| 12 | \$4,425.00 | \$1,820.00 | VARC48 | 2 | 3 |
| 16 | \$5,305.00 | \$2,200.00 | VARC48 | 2 | 4 |
| See page 34-43 for Optional Controls | | | | | |
| For Remote Display Cables use CNP | | | | | |



CRUISAIR AUTHORIZED DISTRIBUTORS AND DEALERS ONLY

MTCGX TITAN Modular Tempering Units, R410A, Replacements Only

| <u>New Item No.</u> | <u>New Description</u> | <u>List Price (USD)</u> | <u>Old Item Number</u> | <u>Old Description</u> |
|---------------------|------------------------|-------------------------|------------------------|------------------------|
| 260161040 | MTCGX36 2361 | \$11,200.00 | 260151040 | MTCGV36C 2361 |
| 260161070 | MTCGX48 2361 | \$11,990.00 | 260127691 | MTCGV48C 2361 |
| 260161072 | MTCGX60 2361 | \$13,100.00 | 260127693 | MTCGV60C 2361 |
| 260161071 | MTCGX48 2363 | \$12,100.00 | 260127692 | MTCGV48DC 2363 |
| 260161073 | MTCGX60 2363 | \$13,100.00 | 260127690 | MTCGV60DC 2363 |
| 260161038 | MTCGX72 2363 | \$14,100.00 | 260151038 | MTCGV72DC 2363 |
| 260161042 | MTCGX96 2363 | \$18,900.00 | 260151042 | MTCGV96DC 2363 |
| 260161043 | MTCGX120 2363 | \$21,400.00 | 260151043 | MTCGV120DC 2363 |
| 260161049 | MTCGX72 3853 | \$14,300.00 | 260151049 | MTCGV72ECK 3853 |
| 260161052 | MTCGX96 3853 | \$19,100.00 | 260151052 | MTCGV96ECK 3853 |
| 260161050 | MTCGX36 4663 | \$11,250.00 | 260151050 | MTCGV36EC 4663 |
| 260161054 | MTCGX72 4663 | \$14,100.00 | 260151054 | MTCGV72EC 4663 |
| 260161051 | MTCGX96 4663 | \$18,900.00 | 260151051 | MTCGV96EC 4663 |

MTDX TITAN Modular Tempering Units, R410A

| <u>New Item No.</u> | <u>New Description</u> | <u>List Price (USD)</u> | <u>Old Item Number</u> | <u>Old Description</u> |
|---------------------|-------------------------|-------------------------|------------------------|----------------------------|
| 260161005 | MTDX30 2361 | \$10,100.00 | 260151005 | MTDV30C, 2361 |
| 260161010 | MTDX36 2361 | \$10,300.00 | 260151010 | MTDV36C, 2361 |
| 260161014 | MTDX48 2361 | \$10,800.00 | 260151014 | MTDV48C, 2361 |
| 260161019 | MTDX60 2361 | \$11,900.00 | 260151019 | MTDV60C, 2361 |
| 260161048 | MTDX48 2361 SmartStart™ | \$11,300.00 | 260151048 | MTDV48C, 2361, Smart Start |
| 260161036 | MTDX60 2361 SmartStart™ | \$12,400.00 | 260151036 | MTDV60C, 2361, Smart Start |
| 260161012 | MTDX36 2363 | \$10,300.00 | 260151012 | MTDV36DC, 2363 |
| 260161016 | MTDX48 2363 | \$10,850.00 | 260151016 | MTDV48DC, 2363 |
| 260161021 | MTDX60 2363 | \$11,900.00 | 260151021 | MTDV60DC, 2363 |
| 260161025 | MTDX72 2363 | \$13,100.00 | 260151025 | MTDV72DC, 2363 |
| 260161028 | MTDX96 2363 | \$18,300.00 | 260151028 | MTDV96DC, 2363 |
| 260161031 | MTDX120 2363 | \$19,900.00 | 260151031 | MTDV120DC, 2363 |
| 260161017 | MTDX48 3853 | \$11,000.00 | 260151017 | MTDV48ECK, 3853 |
| 260161022 | MTDX60 3853 | \$12,100.00 | 260151022 | MTDV60ECK, 3853 |
| 260161026 | MTDX72 3853 | \$13,300.00 | 260151026 | MTDV72ECK, 3853 |
| 260161032 | MTDX120 3853 | \$20,400.00 | 260151032 | MTDV120ECK, 3853 |
| 260161018 | MTDX48 4663 | \$10,850.00 | 260151018 | MTDV48EC, 4663 |
| 260161027 | MTDX72 4663 | \$13,100.00 | 260151027 | MTDV72EC, 4663 |
| 260161030 | MTDX96 4663 | \$18,300.00 | 260151030 | MTDV96EC, 4663 |

Additional sizes and voltages available for MTD units. Contact your sales representative for part number and price.

Notes:

1) Compressor electrical data are nominally rated at the Volt/Hz/Ph listed, and can be operated in the following ranges:

230/60/1 compressors are rated for 208 - 230/60/1; 220/50/1 comps for 220 - 240/50/1; 230/60/3 comps for 208 - 230/60/3;

220/50/3 comps for 200 - 220/50/3; 380/50/3 comps for 380 - 420/50/3; and 460/60/3 comps for 440 - 480/60/3 and 380 - 420/50/3.

These compressors can usually be run at +/-10% of the rated voltage, with these exceptions:

208-230/60/1 -5/+10% for a range of 198-253; and 220-240/50/1 -5/+10% for a range of 209-264.

For more information regarding compressor voltages, refer to field notice FNR#192-B3-C on the Dometic Customer News Website.

2) Dual 50/60Hz Operation: If there is a need for a system to be able to run in both 50Hz and 60Hz environments,

the best solution is to use a VFD. Make sure the pumps are rated 50/60Hz, but sized to provide enough flow at 50Hz.

Chiller Units and Modules

MTD Tempering Unit Bases, Frames, and Headers

MTD Multi-Unit Mounting Bases and Frames

2-ton through 6-ton Units

| # of Stages | Base | Frame |
|-------------|------------|------------|
| 2 | \$1,530.00 | \$3,140.00 |
| 3 | \$1,890.00 | \$3,595.00 |
| 4 | \$2,085.00 | \$3,945.00 |
| 5 | \$2,435.00 | \$4,440.00 |
| 6 | \$3,130.00 | \$5,115.00 |

8-ton and 10-ton Units

| # of Stages | Base | Frame |
|-------------|------------|------------|
| 2 | \$1,755.00 | \$3,225.00 |
| 3 | \$2,065.00 | \$3,580.00 |
| 4 | \$2,375.00 | \$4,185.00 |
| 5 | \$3,165.00 | \$5,340.00 |
| 6 | \$3,700.00 | \$6,235.00 |

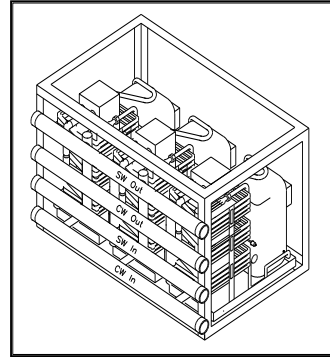

Typical framed chiller with headers

Multi-Unit Chilled Water and Seawater Manifolds

| # of Stages | Chiller Size (Tons) | Manifold Size | Manifold Set |
|-------------|---------------------|---------------|--------------|
| 2 | 4 - 12 | 1.5" | \$4,110 |
| 3 | 4 - 12 | 1.5" | \$5,660 |
| 4 | 4 - 12 | 1.5" | \$7,260 |
| 6 | 12 - 18 | 2.0" | \$10,515 |
| 2 | 13 - 25 | 2.0" | \$4,760 |
| 3 | 13 - 25 | 2.0" | \$6,225 |
| 4 | 13 - 25 | 2.0" | \$7,275 |
| 5 | 13 - 25 | 2.0" | \$9,290 |
| 6 | 24 - 30 | 2.5" | \$13,475 |
| 3 | 26 - 36 | 2.5" | \$9,025 |
| 4 | 26 - 36 | 2.5" | \$11,060 |
| 5 | 26 - 36 | 2.5" | \$12,240 |
| 6 | 36 | 3.0" | \$13,780 |
| 4 | 37 - 60 | 3.0" | \$12,995 |
| 5 | 37 - 60 | 3.0" | \$16,260 |
| 6 | 48 | 3.0" | \$17,100 |
| 6 | 60 | 4.0" | \$19,085 |

TWCX Multi-Unit Bases and Manifolds

| Chiller Tons | TWC Size | Manifold Size | # of Stages | Manifold Set | Base |
|--------------|-----------|---------------|-------------|--------------|------------|
| 4 - 6 | TWCX24-36 | 1.25" | 2 | \$2,450.00 | \$1,525.00 |
| 4 - 6 | TWCX24-30 | 1.25" | 3 | \$3,110.00 | \$1,820.00 |
| 7 - 9 | TWCX30-36 | 1.5" | 3 | \$3,695.00 | \$1,820.00 |
| 10 - 12 | TWCX36 | 2" | 4 | \$5,045.00 | \$2,200.00 |
| 10 - 15 | TWCX24-36 | 2" | 5 | \$6,040.00 | \$2,500.00 |
| 8 - 10 | TWCX48-60 | 1.5" | 2 | \$2,845.00 | \$1,525.00 |
| 12 | TWCX72 | 2" | 2 | \$3,255.00 | \$1,525.00 |
| 12 - 18 | TWCX48-72 | 2" | 3 | \$4,425.00 | \$1,820.00 |
| 16 | TWCX48 | 2" | 4 | \$5,305.00 | \$2,200.00 |
| 20 - 24 | TWCX60-72 | 2.5" | 4 | \$8,125.00 | \$2,200.00 |
| 20 - 30 | TWCX48-72 | 2.5" | 5 | \$8,495.00 | \$2,500.00 |
| 24 - 30 | TWCX48-60 | 2.5" | 6 | \$9,640.00 | \$2,780.00 |
| 36 | TWCX72 | 3" | 6 | \$13,235.00 | \$2,780.00 |

Chiller Units and Modules

TWCX TITAN Chillers with DDC control panel . Switch or display & cables sold separately.

| New Item No. | New Description | List Price (USD) | Old Item Num | Old Description |
|---------------------|-------------------------|-------------------------|---------------------|------------------------|
| 260111400 | TWCX24 2251 DDC 410A | \$6,000.00 | 260111300 | TWCV24CK-DDC 2251 |
| 260111408 | TWCX30 2251 DDC 410A | \$6,445.00 | 260111308 | TWCV30CK-DDC 2251 |
| 260111405 | TWCX36 2251 DDC 410A | \$7,000.00 | 260111305 | TWCV36CK-DDC 2251 |
| 260111447 | TWCX60 2251 DDC 410A | \$9,300.00 | 260111347 | TWCV60CK-DDC 2251 |
| 260111471 | TWCX30 2361 DDC 410A | \$6,500.00 | 260111371 | TWCV30C-DDC 2361 |
| 260111412 | TWCX36-SC 2361 DDC 410A | \$6,850.00 | 260111312 | TWCV36C-DDC 2361 |
| 260111435 | TWCX48 2361 DDC 410A | \$8,700.00 | 260111335 | TWCV48C-DDC 2361 |
| 260111485 | TWCX30 2363 DDC 410A | \$6,800.00 | 260110367 | TWCV30DC-DDC 2363 |
| 260111414 | TWCX36-SC 2363 DDC 410A | \$7,010.00 | 260111314 | TWCV36DC-DDC-SC 2363 |
| 260111473 | TWCX60 2363 DDC 410A | \$9,500.00 | 260111373 | TWCV60DC-DDC 2363 |
| 260111409 | TWCX36-SC 3853 DDC 410A | \$7,305.00 | 260111309 | TWCV36ECK-DDC 3853 |
| 260111423 | TWCX48 3853 DDC 410A | \$9,200.00 | 260111323 | TWCV48ECK-DDC 3853 |
| 260111432 | TWCX60 3853 DDC 410A | \$9,700.00 | 260111332 | TWCV60ECK-DDC 3853 |
| 260111422 | TWCX72 3853 DDC 410A | \$10,900.00 | 260111322 | TWCV72ECK-DDC 3853 |

TWCX Chillers with DDC control panel and SmartStart

| | | | | |
|-----------|----------------------------------|------------|-----------|-------------------------------|
| 260111459 | TWCX30 2361 DDC 410A SmartStart™ | \$7,000.00 | 260111359 | TWCV30C-DDC, 2361 SmartStart |
| 260111463 | TWCX36 2361 DDC 410A SmartStart™ | \$7,350.00 | 260111363 | TWCV36C-DDC, 2361 SmartStart |
| 260111443 | TWCX48 2361 DDC 410A SmartStart™ | \$9,200.00 | 260111343 | TWCV48C-DDC, 2361 SmartStart |
| 260111461 | TWCX30 2251 DDC 410A SmartStart™ | \$6,945.00 | 260111361 | TWCV30CK-DDC 2251 SmartStart |
| 260111460 | TWCX36 2251 DDC 410A SmartStart™ | \$7,500.00 | 260111360 | TWCV36CK-DDC 2251 SmartStart |
| 260111418 | TWCX48 2251 DDC 410A SmartStart™ | \$8,960.00 | 260111318 | TWCV48CK-DDC, 2251 SmartStart |

TWCX Chillers with TWLC control panel.

| | | | | |
|-----------|---------------------------|-------------|-----------|---------------------------|
| 260111403 | TWCX36 2361 TWLC 410A | \$6,950.00 | 260111303 | TWCV36C-TWLC 2361 |
| 260111428 | TWCX48 2361 TWLC 410A | \$8,800.00 | 260111328 | TWCV48C-TWLC 2361 |
| 260111444 | TWCX60 2361 TWLC-RMT 410A | \$9,900.00 | 260111344 | TWCV60C-TWLC-Remote 2361 |
| 260111420 | TWCX72 2361 TWLC 410A | \$10,150.00 | 260111320 | TWCV72C-TWLC , 2361 |
| 260111406 | TWCX36 2251 TWLC 410A | \$7,000.00 | 260111306 | TWCV36CK-TWLC 2251 |
| 260111451 | TWCX60 2251 TWLC 410A | \$9,400.00 | 260111351 | TWCV60CK-TWLC 2251 |
| 260111486 | TWCX30 2363 TWLC 410A | \$6,900.00 | 260110369 | TWCV30DC-TWLC 2363 |
| 260111431 | TWCX48 2363 TWLC 410A | \$9,000.00 | 260111331 | TWCV48DC-TWLC 2363 |
| 260111445 | TWCX60 2363 TWLC-RMT 410A | \$9,950.00 | 260111345 | TWCV60DC-TWLC-Remote 2363 |
| 260111427 | TWCX72 2363 TWLC 410A | \$10,150.00 | 260111327 | TWCV72DC-TWLC 2363 |

TWCX Chillers with TWLC control panel and SmartStart

| | | | | |
|-----------|-----------------------------------|------------|-----------|--------------------------------|
| 260111440 | TWCX48 2361 TWLC 410A SmartStart™ | \$8,800.00 | 260111340 | TWCV48C TWLC, 2361 SmartStart |
| 260111436 | TWCX60 2361 TWLC 410A SmartStart™ | \$9,800.00 | 260111336 | TWCV60C-TWLC, 2361 SmartStart |
| 260111419 | TWCX48 2251 TWLC 410A SmartStart™ | \$9,010.00 | 260111319 | TWCV48CK-TWLC, 2251 SmartStart |

For additional voltages please contact your Cruisair Applications Representative.

Chiller Unit Notes:

1. Only TWCV24-36 chillers come with a remote mountable control box. TWCV48-72 chillers with a remote mountable control box are available (add \$800 list).
2. TWC Chillers have R-410A refrigerant as standard.
3. Pump relays (x2) will be needed if multiple chillers are used.
4. Following parts must be ordered:
 - TWLC keypad/display (one or more)
 - CNP Cables; one per unit, plus one for TWLC keypad
 - A-416/## temp sensor for CW supply
 - Probe well for temp sensor if using plastic pipe.

Manifold Notes:

1. Manifolds are part of a multi-stage chiller system and are not sold separately
2. Call for pricing on vertical frames and manifolds
3. The manifold set includes:
 - Inlet and outlet CW manifolds, insul. copper
 - Inlet and outlet SW manifolds CPVC
 - FPT connections at both ends of manifolds.



TWCV48-72

Chiller Units and Modules

MARINE AIR AUTHORIZED DISTRIBUTORS AND DEALERS ONLY

| MCGX TITAN Modules Reverse Cycle, R410A Refrigerant, DDC Control | | | | | |
|-------------------------------------------------------------------------|-------------------------|-------------------------|----------------------|--------------------------|--|
| <u>New Item No.</u> | <u>New Description</u> | <u>List Price (USD)</u> | <u>Old Item Numb</u> | <u>Old Description</u> | |
| 260162006 | MCGX36 2251 | \$10,400.00 | 260152006 | MCGV36 2251 | |
| 260162010 | MCGX48 2251 | \$10,850.00 | 260152010 | MCGV48 2251 | |
| 260162059 | MCGX48 2251 SmartStart™ | \$11,300.00 | 260152059 | MCGV48 2251 Smart Start™ | |
| 260162015 | MCGX60 2251 | \$11,950.00 | 260152015 | MCGV60 2251 | |
| 260162005 | MCGX36 2361 | \$10,350.00 | 260152005 | MCGV36 2361 | |
| 260162009 | MCGX48 2361 | \$10,800.00 | 260152009 | MCGV48 2361 | |
| 260162039 | MCGX48 2361 SmartStart™ | \$11,300.00 | 260152039 | MCGV48 2361 Smart Start™ | |
| 260162014 | MCGX60 2361 | \$11,900.00 | 260152014 | MCGV60 2361 | |
| 260162038 | MCGX60 2361 SmartStart™ | \$12,400.00 | 260152038 | MCGV60 2361 Smart Start™ | |
| 260162019 | MCGX72 2361 | \$12,740.00 | 260152019 | MCGV72 2361 | |
| 260162007 | MCGX36 2363 | \$10,355.00 | 260152007 | MCGV36 2363 | |
| 260162011 | MCGX48 2363 | \$10,850.00 | 260152011 | MCGV48 2363 | |
| 260162016 | MCGX60 2363 | \$12,000.00 | 260152016 | MCGV60 2363 | |
| 260162020 | MCGX72 2363 | \$13,200.00 | 260152020 | MCGV72 2363 | |
| 260162023 | MCGX90 2363 | \$18,100.00 | 260152023 | MCGV90 2363 | |
| 260162026 | MCGX120 2363 | \$19,800.00 | 260152026 | MCGV120 2363 | |
| 260162012 | MCGX48 3853 | \$11,000.00 | 260152012 | MCGV48 3853 | |
| 260162017 | MCGX60 3853 | \$12,250.00 | 260152017 | MCGV60 3853 | |
| 260162021 | MCGX72 3853 | \$13,500.00 | 260152021 | MCGV72 3853 | |
| 260162024 | MCGX90 3853 | \$18,400.00 | 260152024 | MCGV90 3853 | |
| 260162027 | MCGX120 3853 | \$20,000.00 | 260152027 | MCGV120 3853 | |
| 260162030 | MCGX150 3853 | \$28,720.00 | 260152030 | MCGV150 3853 | |
| 260162033 | MCGX180 3863 | \$30,480.00 | 260152033 | MCGV180 3863 | |
| 260162013 | MCGX48 4663 | \$10,850.00 | 260152013 | MCGV48 4663 | |
| 260162018 | MCGX60 4663 | \$12,000.00 | 260152018 | MCGV60 4663 | |
| 260162028 | MCGX120 4663 | \$19,800.00 | 260152028 | MCGV120 4663 | |

Notes for MCGV Chillers

1. DDC modules are "Stand Alone", single stage MCG chillers with DDC controls, one electrical box per stage. These modules can be staged together to the required total capacity. Each module requires a dedicated circuit breaker in the ship's A/C panel. *OTS Box or Mechanical Switch is REQUIRED
2. Multi-Stage modules can be calculated by taking DDC List price less \$800. These modules are part of a multi-staged system with a single multi-unit "welded" control panel containing CWMC or TWLC controls & one circuit breaker per stage.
3. For 380/460V DDC "stand-alone" modules that do not have 115V or 230V available (either separate control power feed or a neutral), add \$175 per stage for a transformer that will be included in the DDC box.

| MCGX-LP TITAN 'Low Profile' Modules Reverse Cycle R410A Refrigerant, DDC Control | | | | | |
|---------------------------------------------------------------------------------------------|---------------------------|-------------------------|----------------------|---------------------------|--|
| <u>New Item No.</u> | <u>New Description</u> | <u>List Price (USD)</u> | <u>Old Item Numb</u> | <u>Old Description</u> | |
| 260163001 | MCGXLP36 2361 | \$11,500.00 | 260153001 | MCGVLP36 2361 | |
| 260163005 | MCGXLP48 2361 | \$12,200.00 | 260153005 | MCGVLP48 2361 | |
| 260163042 | MCGXLP48 2361 SmartStart™ | \$12,700.00 | 260153042 | MCGVLP48 2361 Smart Start | |
| 260163010 | MCGXLP60 2361 | \$13,000.00 | 260153010 | MCGVLP60 2361 | |
| 260163026 | MCGXLP60 2361 SmartStart™ | \$13,500.00 | 260153026 | MCGVLP60 2361 Smart Start | |
| 260163003 | MCGXLP36 2363 | \$11,600.00 | 260153003 | MCGVLP36 2363 | |
| 260163007 | MCGXLP48 2363 | \$12,400.00 | 260153007 | MCGVLP48 2363 | |
| 260163012 | MCGXLP60 2363 | \$13,000.00 | 260153012 | MCGVLP60 2363 | |
| 260163016 | MCGXLP72 2363 | \$14,300.00 | 260153016 | MCGVLP72 2363 | |
| 260163013 | MCGXLP60 3853 | \$13,800.00 | 260153013 | MCGVLP60 3853 | |
| 260163017 | MCGXLP72 3853 | \$14,700.00 | 260153017 | MCGVLP72 3853 | |
| 260163014 | MCGXLP60 4663 | \$13,000.00 | 260153014 | MCGVLP60 4663 | |

Additional sizes and voltages available. Call your sales representative for part number and price.

Chiller Units and Modules

MARINE AIR AUTHORIZED DISTRIBUTORS AND DEALERS ONLY

| MCG CHILLER BASES | | | |
|--------------------------|----------------|-----------------|------------------|
| <u># of Stages</u> | <u>2-6 ton</u> | <u>7-10 ton</u> | <u>12-15 ton</u> |
| 2 | \$1,397.00 | \$1,676.00 | \$1,750.00 |
| 3 | \$1,634.00 | \$1,933.00 | \$2,039.00 |
| 4 | \$1,876.00 | \$2,138.00 | \$2,343.00 |
| 5 | \$2,081.00 | \$2,343.00 | \$2,647.00 |

Note: Use 7-10 ton base price for 50hz 6-ton chillers

| MCG CHILLER MANIFOLDS SETS | | | | |
|-----------------------------------|----------------------|--------------------|---------------------|------------------------------|
| <u>Chiller Tons</u> | <u>Manifold Size</u> | <u># of Stages</u> | <u>Manifold Set</u> | <u>Dual Feed add per Set</u> |
| 4 - 10 | 1.5" | 2 | \$3,614.00 | \$228.00 |
| 4 - 10 | 1.5" | 3 | \$4,581.00 | \$228.00 |
| 4 - 10 | 1.5" | 4 | \$6,383.00 | \$228.00 |
| 11 - 18 | 2.0" | 2 | \$3,740.00 | \$230.00 |
| 11 - 18 | 2.0" | 3 | \$4,408.00 | \$230.00 |
| 11 - 18 | 2.0" | 4 | \$5,080.00 | \$230.00 |
| 11 - 18 | 2.0" | 5 | \$5,750.00 | \$230.00 |
| 19 - 33 | 2.5" | 2 | \$6,535.00 | \$601.00 |
| 19 - 33 | 2.5" | 3 | \$6,672.00 | \$601.00 |
| 19 - 33 | 2.5" | 4 | \$6,803.00 | \$601.00 |
| 19 - 33 | 2.5" | 5 | \$6,937.00 | \$601.00 |
| 34 - 50 | 3.0" | 3 | \$10,192.00 | \$799.00 |
| 34 - 50 | 3.0" | 4 | \$11,431.00 | \$799.00 |
| 34 - 50 | 3.0" | 5 | \$12,639.00 | \$799.00 |

The manifold set includes:

- Inlet and outlet CW manifolds, insulated copper
- Inlet and outlet SW manifolds, PVC, with cleanout plug at opposite end of manifold connection
- FPT connections at one end of manifold

Manifolds are part of a multi-stage chiller system and are not sold separately. Call for pricing on vertical frames and manifolds.
The Dual-Feed option allows connection at either side of manifold; both sides will have FPT connection, with a plug in one end.

| Chiller Compact (CHC) R410A Units and Accessories | | |
|---------------------------------------------------------------|-------------------------|------------------------------------|
| <u>Item Number</u> | <u>List Price (USD)</u> | <u>Description</u> |
| CHILLER COMPACT, R410A | | |
| 260114006 | \$3,650.00 | CHCG16 PVE 1161 |
| 260114005 | \$3,950.00 | CHCG16 PVE 1161 SmartStart™ |
| 260114013 | \$3,650.00 | CHCG16Z PVE 2361 |
| 260114010 | \$4,290.00 | CHCG16Z PVE 2361 SmartStart™ |
| 260114020 | \$5,015.00 | CHCG20Z PVE 2361 SmartStart™ |
| 260114012 | \$4,725.00 | CHCG24Z PVE 2361 |
| 260114024 | \$5,325.00 | CHCG24Z PVE 2361 SmartStart™ |
| 260114030 | \$4,875.00 | CHCG24Z3 PVE 2363 |
| 260114011 | \$3,750.00 | CHCG16Z50 PVE 2251 |
| 260114009 | \$4,190.00 | CHCG16Z50 PVE 2251 SmartStart™ |
| CHILLER COMPACT MOUNTING BASES | | |
| 291700319 | \$1,340.00 | 2 CHC20@50HZ or 24 without Pmp Pkg |
| 291700191 | \$1,300.00 | 3 CHC20@50HZ or 24 without Pmp Pkg |
| 291700178 | \$1,720.00 | 4 CHC20@50HZ or 24 without Pmp Pkg |
| CHILLER COMPACT MANIFOLD SETS (Copper CW & PVC SW) | | |
| 297500064 | \$1,400.00 | 2 CHC16 or 2 CHC20@60HZ (1.00") |
| 297500065 | \$1,400.00 | 2 CHC20@50HZ or 2 CHC24 (1.00") |
| 298001112 | \$2,650.00 | 3 CHC20@50HZ or 3 CHC24 (1.25") |



Note: CHC16-20 should be sized to 100%, while CHC24 should be sized to 90% of the total air handler load.

Chilled Water Electrical Panels

PLC CONTROL PANEL STANDARD PACKAGE

| # of Stages | 208-230V 1ph | 208-230V 3ph | 380-460V 3ph |
|-------------|-----------------|-----------------|-----------------|
| 2 | \$9,900.00 | \$10,570.00 | \$10,860.00 |
| 3 | \$12,025.00 | \$13,290.00 | \$13,690.00 |
| 4 | \$14,130.00 | \$15,060.00 | \$15,560.00 |
| 5 | \$15,865.00 | \$16,765.00 | \$18,170.00 |
| 6 | \$17,570.00 | \$19,050.00 | \$19,670.00 |



Notes:

1. The Standard Package includes the standard PLC PGD1 controller.
3. Above Pricing includes circuit breakers and relays for compressors, CW & SW pumps
4. 380-460V panels include a transformer for control power
5. Does not support touch screen or remote connectivity.

PLC CONTROL PANEL PLATINUM PACKAGE

| # of Stages | 208-230V 1ph-3ph | 380-460V 3ph | 208-230V 1ph-3ph | 380-460V 3ph |
|-------------|--------------------------------|--------------------------------|---------------------------------|---------------------------------|
| | 7" PLC Colored Touch Screen | 7" PLC Colored Touch Screen | 13" PLC Colored Touch Screen | 13" PLC Colored Touch Screen |
| 2 | \$14,000.00 | \$14,286.00 | \$16,791.00 | \$17,076.00 |
| 3 | \$16,642.00 | \$17,033.00 | \$19,432.00 | \$19,823.00 |
| 4 | \$20,039.00 | \$20,521.00 | \$22,829.00 | \$23,311.00 |
| 5 | \$21,692.00 | \$23,056.00 | \$24,482.00 | \$25,846.00 |
| 6 | \$23,919.00 | \$24,523.00 | \$26,709.00 | \$27,313.00 |



Notes:

1. Available with 7" or 13" colored touch screen.
2. Above Pricing includes circuit breakers and relays for compressors, CW & SW pumps
3. 380-460V panels include a transformer for control power
4. See below for Upgrade Options

PLC Panel Platinum Package Upgrades

| # of Stages | Upgrade 1 | Upgrade 2 | Platinum List Price (Upgrade 1 & 2) |
|-------------|------------|------------|----------------------------------------|
| 2 | \$3,392.00 | \$1,128.00 | \$4,520.00 |
| 3 | \$4,834.00 | \$1,280.00 | \$6,114.00 |
| 4 | \$6,784.00 | \$2,032.00 | \$8,816.00 |
| 5 | \$8,226.00 | \$2,184.00 | \$10,410.00 |
| 6 | \$9,404.00 | \$2,336.00 | \$11,740.00 |



Platinum Package Upgrade 1 Includes: All features of the Platinum Package plus, Suction and Discharge

Upgrade 2 Includes: Temperature Sensors and Pressure Transducers, Chilled Water pump current, Seawater pump current, and Compressor current monitoring without VFD

Chilled Water Electrical Panels

| PLC Panel Optional Additional Parts | | |
|--------------------------------------------------------------|----------------------------------------------------------------------------------------------------------------------------------------------------------------------------------------------------------------------------|-----------|
| <u>Description</u> | <u>List Price (USD)</u> | |
| 7inch Touch Screen | \$2,000.00 | |
| 13inch Touch Screen | \$4,850.00 | |
| PLDPro PLC Small Display | \$300.00 | |
| PGD1 Remote PLC Display | \$555.00 | |
| Cable 9 pin to 3 pin for 13" display | \$105.00 | |
| Splitter for multiple PGD1 displays | \$70.00 | |
| Spare pump selector switch, 1-Phase (with contactor): | \$500.00 | each |
| Spare pump selector switch, 3-Phase (with relay & overload): | \$825.00 | each |
| Extend harness (10' std, up to 30'): | \$260.00 | per stage |
| Dual power input (split-bus): | \$255.00 | |
| Dual doors (wide panels): | \$685.00 | |
| Mount panel on chiller frame: | \$365.00 | |
| Water Pressure Transducer | \$767.00 | each |
| Electronic Expansion Valve for Platinum PLC Upgrade 1: | | |
| EEV for 2 to 8 Ton Chillers | \$165.00 | |
| EEV for 10 Ton Chillers and Up | \$450.00 | |
| PLC Parts Descriptions | | |
| PLC | Main control with embedded display for operation, one per 3 stages. If touch screen is not used, the user has the option of using the embedded screen on the PLC or a remote display (337420), which mirrors the main PLC. | |
| Touchscreen | Graphical display(s), Required if remote connectivity is desired for remote operation and diagnosis. Platinum series only. | |
| Current Transducer | Used to monitor the amperage of compressors and (or) pumps, for display and fault sensing. | |
| Pressure Transducer | Monitors the refrigerant pressure or water pressure for display and fault sensing. | |

| STIIC | | |
|----------------------------------------------------------------------------------------------------------------------------------------------------------------------------------------------------------------------------------------------------------|-------------------------|----------------------------------------------------------------------------------|
| <u>Item No.</u> | <u>List Price (USD)</u> | <u>Description</u> |
| 263400309 | \$5,405.00 | KIT CNTL STIIC PLC-7" E/BOX |
| Includes Control for--6-stage chiller, 10-airhandler or DX controls with canbus, 2-Eskimo Ice, 6-KRA units, 18-Cooler box controls, 2-XTC Watermakers, 2-ZTC Spot Zero Water Purifiers (Option to upgrade up to 40 airhandler or DX Controls with canbus | | |
| 337996 | \$1,245.00 | ADF converter Modbus to Canbus USED with STIIC for talking to Canbus Controllers |

| PLC-OTS Electric Boxes for PLC Chiller Modules (MARINE AIR ONLY) | | |
|-----------------------------------------------------------------------------------------------------------------------------------------------------------------------------------------------------------------------------------------------------------------------------------------------------------------------------------------------------------------------|-----------------------|--------------------------------------------------------------|
| This electric box can be used with 2 to 6 stage MCW chillers with PLC controls as either a field retrofit (see notice below) or it can be ordered with a new chiller. The box contains the, SW & CW pump contactors (and overloads if 3 ph), a term. block for pump & power connections, PGD1 White Marine Air display in the lid. Circuit breakers are not included. | | |
| Order parts from the lists below to create a complete PLC-OTS box & harness assembly. | | |
| <u>Item No.</u> | <u>List Price USD</u> | <u>Description</u> |
| 263600223 | \$1,350.00 | Single phase CWPLC-OTS box with two 230VAC pump contactors. |
| 263600231 | \$1,350.00 | Single phase CWPLC-OTS box with two 115VAC pump contactors. |
| 263600224 | \$1,400.00 | Three phase CWPLC-OTS box with two 230VAC pump contactors. |
| TBD | Call For Price | Three phase CWPLC-OTS box with three 230VAC pump contactors. |
| TBD | Call For Price | Three phase CWPLC-OTS box with four 230VAC pump contactors. |
| Notes: | | |
| 1. Box dimensions: Standard is 14"Hx12"Wx4.7"D, add 1 or 2 pumps and dimensions are 11"Hx15"Wx4.7"D. | | |
| 2. Need to specify 3 phase pump volts & amps and/or horsepower when ordering 3 phase boxes. | | |
| 3. 380-460VAC power supplied chillers should use the 230VAC pump contactor OTS boxes. | | |

Chilled Water Electrical Panels

Single-Unit MPLC Modular Control Panels for Cruisair MTDV (CRUISAIR ONLY)

| <u>Item Number</u> | <u>List Price (USD)</u> | <u>Description</u> |
|--------------------|-------------------------|--------------------------------------------------------------------------|
| 263200017 | \$1,975.00 | MPLC-XC For all MTDV Units, 208-480V, 1 & 3 Ph, 115/230V without Display |
| 263200018 | \$1,975.00 | MPLC-VXC Control Panel, As Above, for use with VFD's |

In addition to the MPLC single-unit panel (one per chiller), the system will require; a Standard PLC display (PGD1), CNP5 Network Cables (one per panel), 2x pump relays (for circulation and seawater pumps),

Additional PLC Control Panel Parts

| <u>Item No.</u> | <u>List Price (USD)</u> | <u>Description</u> |
|-----------------|-------------------------|---------------------------------------------------------------------------------------|
| 336868 | \$13.00 | 5' Display Cable for PGD1 |
| 337421 | \$9.00 | 2.5' Display Cable for PGD1 |
| 336951 | \$2,070.00 | CONTROL, PLC LARGE PCO5+ w/built in PGD1 display, used on High End |
| 338083 | \$1,780.00 | CONTROL, STIIC PCO5 SMALL w/built in PGD1 display |
| 263120358 | \$580.00 | CONTROL, PLC 230VAC used on basic chiller |
| 263400120 | \$760.00 | CONTROL, PLC SML 230VAC EEV used for VARC48 |
| 263120356 | \$2,820.00 | CONTROL, PLC HE Chillers |
| 337668 | Call For Price | CONTROL, PLC MED 230V EEV used for basic chiller w/options |
| 4025103 | \$210.00 | TRANSDU PRES 0-652PSIG 1/4 FPT |
| 337422 | \$34.00 | 14.4"WIRE SET w/plug for Pres Transducers |
| 336862 | \$22.00 | 6.5"WIRE SET w/plug for Pres Transducers |
| 336863 | \$34.00 | Chiller temp sensor 10 ft cable |
| 337423 | \$42.00 | Chiller temp sensor 20 ft cable |
| 337429 | Call For Price | Harness control, MTD Water Temp Sensors |
| 337337 | \$215.00 | Harness Control, Pressure transducers w/ seawater sensor (replacements and retrofits) |
| 263120355 | \$830.00 | Repl EVO Driver w/display for programming |
| 336872 | \$41.00 | EEV connector and cable 9.8 ft long |
| 337561 | \$345.00 | EVO Driver Display only |
| 337041 | \$285.00 | Field Bus 1 comm board |

Other Chilled Water Accessories

| <u>Item No.</u> | <u>List Price USD</u> | <u>Description</u> |
|------------------------------------------------------------------------------------------|-----------------------|------------------------------|
| Probe Well Assy. Tee for water sensor - for retrofits or if building new manifold | | |
| 297700671 | \$225.00 | 1.5" SCH80 PVC |
| 297700672 | \$235.00 | 2.0" SCH80 PVC |
| 297700676 | \$75.00 | Copper probe well (braze-in) |

Pressure/Temperature Gauges/Valves/Misc.

| | | |
|-----------|----------|-------------------------------------------------|
| 4061200 | \$415.00 | Humidistat, Wall Mount, 115V/230V |
| 263600110 | \$445.00 | Pressure/Temperature Gauge Kit Panel |
| 263600125 | \$585.00 | Pressure/Temperature Gauge Kit Box |
| 263600080 | \$170.00 | Pressure gauge only in panel w/5' tube |
| 330127 | \$165.00 | Probe well for temperature gauge sensor CW |
| 360586 | \$145.00 | Temperature dial gauge (for panel) |
| 334215 | \$130.00 | Pressure dial gauge, USG black casing |
| 330482 | \$45.00 | 1/2" NPT Brass Ball Valve (tapered full port) * |

Notes:

1. Press/Temp Gauge kit has 1 press gauge for return water, and 2 temp gauges for supply and return water.
2. Purchase probe well #330127 if buying gauge panel or box separately from manifolds.

Variable Frequency Drives

| Programmed Variable Frequency Drives | | | | | |
|--------------------------------------------------------------|-----------------------|-----------------------|----------------|-----------------|-------------------|
| Altivar 312 Variable Frequency Drives (Standard VFDs) | | | | | |
| <u>Nominal HP</u> | <u>Comp</u> | <u>Max AMP Rating</u> | | <u>VFD 312</u> | |
| | <u>Voltage In/Out</u> | <u>3-Ph In</u> | <u>1-Ph In</u> | <u>Item No.</u> | <u>List Price</u> |
| 5HP | 2361>2363 | - | 10.1 | 263250506 | \$1,975.00 |
| 7.5HP | 2361>2363 | - | 15.9 | 263250503 | \$2,575.00 |
| 15HP | 2361>2363 | - | 31.2 | 263250511 | \$3,975.00 |
| 10HP | 2361>2363 | - | 19.1 | 263250502 | \$2,775.00 |
| 20HP | 2361>2363 | - | 38.1 | 263250508 | \$4,425.00 |
| 5HP | 2251>2363 | - | 10.1 | 263250504 | \$1,975.00 |
| 7.5HP | 2351>2363 | - | 15.9 | 263250523 | \$2,575.00 |
| 10HP | 2251>2253 | - | 19.1 | 263250521 | \$2,775.00 |
| 15HP | 2351>2363 | - | 31.2 | 263250522 | \$3,975.00 |
| 10HP | 2351>2363 | - | 19.1 | 263250510 | \$2,775.00 |
| 5HP | 2363>2363 | 17.5 | - | 263250525 | \$1,975.00 |
| 7.5HP | 2363>2363 | 27.5 | - | 263250513 | \$2,575.00 |
| 15HP | 2363>2363 | 54 | - | 263250512 | \$3,975.00 |
| 10HP | 2363>2363 | 33 | - | 263250507 | \$2,775.00 |
| 5HP | 3853>3853 | 9.5 | - | 263250529 | \$1,875.00 |
| 7.5HP | 3853>3853 | 14.3 | - | 263250505 | \$2,175.00 |
| 10HP | 3853>3853 | 17 | - | 263250517 | \$2,550.00 |
| 15HP | 3853>3853 | 27.7 | - | 263250519 | \$3,725.00 |

| Altivar 21 Variable Frequency Drives (Lower Harmonic Distortion VFDs) | | | | |
|------------------------------------------------------------------------------|-----------------------|-----------------------|-----------------|-------------------|
| <u>Nominal HP</u> | <u>Voltage In/Out</u> | <u>Max AMP Rating</u> | <u>Item No.</u> | <u>List Price</u> |
| 7.5HP | 4063>4063 | 12 | 263250540 | \$2,350.00 |
| 15HP | 4053>4053 | 22.5 | 263250536 | \$3,750.00 |
| 15HP | 4053>4063 | 22.5 | 263250524 | \$3,750.00 |
| 20HP | 4053>4063 | 30.5 | 263250539 | \$4,250.00 |

| RFI Filters (Eliminate High Frequency Interference) | | | | | |
|------------------------------------------------------------|----------------|-----------------------|----------------|----------------------------------|-------------------|
| <u>Nominal HP</u> | <u>Comp</u> | <u>Max AMP Rating</u> | | <u>RFI Filters (class B EMC)</u> | |
| | <u>Voltage</u> | <u>3-Ph In</u> | <u>1-Ph In</u> | <u>Item No.</u> | <u>List Price</u> |
| 5HP | 208-230V | 17.5 | 10.1 | 763300002 | \$665.00 |
| 7.5HP | 208-230V | 27.5 | 15.9 | 763300003 | \$700.00 |
| 10HP | 208-230V | 33 | 19.1 | 763300003 | \$700.00 |
| 15HP | 208-230V | 54 | 31.2 | 763300004 | \$1,050.00 |
| 20HP | 208-230V | 66 | 38.1 | 763300004 | \$1,050.00 |
| 5HP | 380-460V | 9.5 | - | 763300002 | \$665.00 |
| 7.5HP | 380-460V | 14.3 | - | 763300003 | \$700.00 |
| 10HP | 380-460V | 17 | - | 763300003 | \$700.00 |

Note: RFI Filters are Compatible with either the Altivar 31s or the Altivar 21s.

| AC Line Reactors (Reduce Total Harmonic Distortion (THD)) | | |
|------------------------------------------------------------------|-----------------------|-----------------------------|
| <u>Item No.</u> | <u>List Price USD</u> | <u>Description</u> |
| 4250301 | \$885.00 | Reactor, AC Line 230V, 10HP |
| 4250303 | \$990.00 | Reactor, AC Line 230V, 15HP |
| 4250302 | \$990.00 | Reactor, AC Line 460V, 15HP |
| 4250304 | \$1,450.00 | Reactor, AC Line 230V, 25HP |

Chilled Water Air Handlers

| | | | | | | | | | | | | | | |
|-------------------|--------------------------|------------------------------------------------------------------------------------------|--------------------------|---|--------------|---|---------------------------------------|---|-----------------|---|--------------|---|----------------------------|----------------|
| AU | 12 | HV | Z | - | FC | - | COS | - | 2KW | - | BE | - | L90 | 6"MR |
| Air Handler Style | Capacity (BTU/Hr x 1000) | Blower "HV" = High-efficiency DC = DC Brushless Motor F = Shaded Pole (ext. motor) | Z = 230V Blank = 115V | | Flow Control | | COS = Change-Over Switch Installed | | Electrical Heat | | Breathe Easy | | Valve & Blower Orientation | Duct Ring Size |

AU Air Handlers, with High Velocity Blowers

| Item Number | List Price (USD) | Description |
|-------------|------------------|-------------------|
| 261400061 | \$1,660.00 | AU6HV 5"MR 115V |
| 261400091 | \$1,760.00 | AU9HV 6"MR 115V |
| 261400121 | \$1,860.00 | AU12HV 6"MR 115V |
| 261400181 | \$2,060.00 | AU18HV 7"MR 115V |
| 261400241 | \$2,360.00 | AU24HV 8"MR 115V |
| 261400060 | \$1,660.00 | AU6HVZ 5"MR 230V |
| 261400090 | \$1,760.00 | AU9HVZ 6"MR 230V |
| 261400120 | \$1,860.00 | AU12HVZ 6"MR 230V |
| 261400180 | \$2,060.00 | AU18HVZ 7"MR 230V |
| 261400240 | \$2,360.00 | AU24HVZ 8"MR 230V |

AU Air Handlers, with HV Blowers and Heating

| | | |
|-----------|------------|---------------------------|
| 261400065 | \$2,010.00 | AU6HVZ-1KW 5"MR 115V |
| 261400095 | \$2,110.00 | AU9HV-1KW 6"MR 115V |
| 261400107 | \$2,110.00 | AU9HV-1.5KW 6"MR 115V |
| 261400137 | \$2,210.00 | AU12HV-1KW 6"MR 115V |
| 261400125 | \$2,210.00 | AU12HV-1.5KW 6"MR 115V |
| 261400197 | \$2,410.00 | AU18HV-1KW 7"MR 115V |
| 261400201 | \$2,410.00 | AU18HV-1.5KW 7"MR 115V |
| 261400245 | \$2,810.00 | AU24HVZ-3.0KW 8"MR 230V |
| 261400064 | \$2,010.00 | AU6HVZ-1KW 5"MR 230V |
| 261400094 | \$2,110.00 | AU9HVZ-1KW 6"MR 230V |
| 261400106 | \$2,110.00 | AU9HVZ-1.5KW 6"MR 230V |
| 261400136 | \$2,210.00 | AU12HVZ-1KW 6"MR 230V |
| 261400124 | \$2,210.00 | AU12HVZ-1.5KW 6"MR 230V |
| 261400196 | \$2,410.00 | AU18HVZ-1KW 7"MR 230V |
| 261400200 | \$2,410.00 | AU18HVZ-1.5KW 7"MR 230V |
| 261400244 | \$2,810.00 | AU24HVZ-2X1.5KW 8"MR 230V |



AU Air Handlers, with HV Blowers and Flow Control

| | | |
|-----------|------------|----------------------|
| 261400063 | \$1,820.00 | AU6HV-FC 5"MR 115V |
| 261400093 | \$1,920.00 | AU9HV-FC 6"MR 115V |
| 261400123 | \$2,020.00 | AU12HV-FC 6"MR 115V |
| 261400183 | \$2,220.00 | AU18HV-FC 7"MR 115V |
| 261400243 | \$2,520.00 | AU24HV -FC 8"MR 115V |
| 261400062 | \$1,820.00 | AU6HVZ-FC 5"MR 230V |
| 261400092 | \$1,920.00 | AU9HVZ-FC 6"MR 230V |
| 261400122 | \$2,020.00 | AU12HVZ-FC 6"MR 230V |
| 261400182 | \$2,220.00 | AU18HVZ-FC 7"MR 230V |
| 261400242 | \$2,520.00 | AU24HVZ-FC 8"MR 230V |

AU Air Handlers, with HV Blowers, FC and Heating

| | | |
|-----------|----------------|----------------------------|
| 261400067 | Call For Price | AU6HV-FC 1.0KW 5"MR 115V |
| 261400127 | Call For Price | AU12HV-FC 1.5KW 6"MR 115V |
| 261400247 | Call For Price | AU24HV-FC 3.0KW 8"MR 115V |
| 261400066 | \$2,170.00 | AU6HVZ-FC 1.0KW 5"MR 230V |
| 261400126 | \$2,370.00 | AU12HVZ-FC 1.5KW 6"MR 230V |
| 261400246 | \$2,970.00 | AU24HVZ-FC 3.0KW 8"MR 230V |

Chilled Water Air Handlers

| AU Air Handlers, with HV Blowers, FC and COS | | |
|-------------------------------------------------------------------|-------------------------|------------------------------|
| Item Number | List Price (USD) | Description |
| 261400901 | \$1,870.00 | AU6HVZ-FC-COS 5"MR 230V |
| 261400917 | \$1,970.00 | AU9HVZ-FC-COS 6"MR 230V |
| 261400926 | \$2,070.00 | AU12HVZ-FC-COS 6"MR 230V |
| 261400908 | \$2,270.00 | AU18HVZ-FC-COS 7"MR 230V |
| 261400949 | \$2,570.00 | AU24HVZ-FC-COS 8"MR 230V |
| AU Air Handlers, with HV Blowers, and Breathe Easy™ | | |
| 261400956 | \$2,155.00 | AU6HVZ-BE 5"MR 230V |
| 261400969 | \$2,255.00 | AU9HVZ-BE 5"MR 230V |
| 261400957 | \$2,355.00 | AU12HVZ-BE 6"MR 230V |
| 261400970 | \$2,555.00 | AU18HVZ-BE 7"MR 230V |
| 261400958 | \$2,855.00 | AU24HVZ-BE 8"MR 230V |
| AU Air Handlers, w/HV Blowers, Breathe Easy™ & Heating | | |
| 261400790 | \$2,505.00 | AU6HV-1KW-BE 5"MR 115V |
| 261400791 | \$2,605.00 | AU9HV-1KW-BE 5"MR 115V |
| 261400792 | \$2,705.00 | AU12HV-1.5KW-BE 6"MR 115V |
| 261400793 | \$3,005.00 | AU18HV-2X1.5KW-BE 7"MR 115V |
| 261400794 | \$3,305.00 | AU24HV-2X1.5KW-BE 8"MR 115V |
| 261400800 | \$2,505.00 | AU6HVZ-1KW-BE 5"MR 230V |
| 261400801 | \$2,605.00 | AU9HVZ-1KW-BE 5"MR 230V |
| 261400802 | \$2,705.00 | AU12HVZ-1.5KW-BE 6"MR 230V |
| 261400803 | \$3,005.00 | AU18HVZ-2X1.5KW-BE 7"MR 230V |
| 261400804 | \$3,305.00 | AU24HVZ-2X1.5KW-BE 8"MR 230V |
| AU Air Handlers, with DC Blowers | | |
| 261400069 | \$2,580.00 | AU6DCZ 5"MR 230V |
| 261400099 | \$2,680.00 | AU9DCZ 6"MR 230V |
| 261400129 | \$2,780.00 | AU12DCZ 6"MR 230V |
| 261400189 | \$2,980.00 | AU18DCZ 7"MR 230V |
| 261400249 | \$3,280.00 | AU24DCZ 8"MR 230V |
| AU Air Handlers, with DC Blowers and Heating | | |
| 261400071 | \$2,930.00 | AU6DCZ-1KW 5"MR 230V |
| 261400101 | \$3,030.00 | AU9DCZ-1KW 6"MR 230V |
| 261400110 | \$3,030.00 | AU9DCZ-1.5KW 6"MR 230V |
| 261400131 | \$3,130.00 | AU12DCZ-1.5KW 6"MR 230V |
| 261400191 | \$3,330.00 | AU18DCZ-1.5KW 7"MR 230V |
| 261401037 | \$3,630.00 | AU24DCZ-1.5KW 8"MR 230V |
| AU Air Handlers, with DC Blowers and Flow Control | | |
| 261400070 | \$2,740.00 | AU6DCZ-FC 5"MR 230V |
| 261400100 | \$2,840.00 | AU9DCZ-FC 6"MR 230V |
| 261400130 | \$2,940.00 | AU12DCZ-FC 6"MR 230V |
| 261400190 | \$3,140.00 | AU18DCZ-FC 7"MR 230V |
| 261400250 | \$3,440.00 | AU24DCZ-FC 8"MR 230V |
| AU Air Handlers, with DC Blowers, FC and Heating | | |
| 261400072 | \$3,090.00 | AU6DCZ-FC-1KW 5"MR 230V |
| 261400102 | \$3,165.00 | AU9DCZ-FC-1KW 6"MR 230V |
| 261400192 | \$3,490.00 | AU18DCZ-FC-1.5KW 7"MR 230V |
| 261401036 | \$3,790.00 | AU24DCZ-FC-1.5KW 8"MR 230V |
| AU Air Handlers, with DC Blowers, FC and COS | | |
| 261400913 | \$2,765.00 | AU6DCZ-FC-COS 5"MR 230V |
| 261400939 | \$2,890.00 | AU9DCZ-FC-COS 6"MR 230V |
| 261400941 | \$2,990.00 | AU12DCZ-FC-COS 6"MR 230V |
| 261400947 | \$3,165.00 | AU18DCZ-FC-COS 7"MR 230V |
| 261400952 | \$3,465.00 | AU24DCZ-FC-COS 8"MR 230V |



*Note: U-board does not support COS
Use water temp sensor

Chilled Water Air Handlers

European Version Air Handlers

AU-EU Air Handlers, with HV Blowers

| Item Number | List Price (USD) | Description |
|-------------|------------------|----------------------|
| 261402006 | \$1,830.00 | AU6HVZ-EU 5"MR 230V |
| 261402009 | \$1,930.00 | AU9HVZ-EU 6"MR 230V |
| 261402012 | \$2,030.00 | AU12HVZ-EU 6"MR 230V |
| 261402018 | \$2,230.00 | AU18HVZ-EU 7"MR 230V |
| 261402024 | \$2,530.00 | AU24HVZ-EU 8"MR 230V |

AU-EU Air Handlers, with HV Blowers and Heating

| | | |
|-----------|------------|------------------------------|
| 261402007 | \$2,180.00 | AU6HVZ-EU-1KW 5"MR 230V |
| 261402010 | \$2,280.00 | AU9HVZ-EU-1.5KW 6"MR 230V |
| 261402019 | \$2,580.00 | AU18HVZ-EU-1.5KW 7"MR 230V |
| 261402025 | \$2,930.00 | AU24HVZ-EU-2X1.5KW 8"MR 230V |

AU-EU Air Handlers, with DC Blowers

| | | |
|-----------|------------|----------------------|
| 261402050 | \$2,750.00 | AU6DCZ-EU 5"MR 230V |
| 261402051 | \$2,850.00 | AU9DCZ-EU 6"MR 230V |
| 261402052 | \$2,950.00 | AU12DCZ-EU 6"MR 230V |
| 261402053 | \$3,150.00 | AU18DCZ-EU 7"MR 230V |
| 261402054 | \$3,450.00 | AU24DCZ-EU 8"MR 230V |

AU-EU Air Handlers, with DC Blowers and Heating

| | | |
|-----------|------------|------------------------------|
| 261402056 | \$3,500.00 | AU18DCZ-EU-1.5KW 7"MR 230V |
| 261402055 | \$4,150.00 | AU24DCZ-EU-2X1.5KW 8"MR 230V |

Control Box for AU-EU High Velocity Blowers

| | | |
|-----------|----------|--------------------------------------------|
| 263400920 | \$710.00 | Control Box AU-HV-EU I/O 20' display cable |
| 263400921 | \$780.00 | Control Box AU-HV-EU Q-Logic |
| 263400922 | \$260.00 | Control Box AU-HV-EU Slave |

Control Box for AU-EU DC Blowers

| | | |
|-----------|----------|--------------------------------------------|
| 263400923 | \$745.00 | Control Box AU-DC-EU I/O 20' display cable |
| 263400924 | \$815.00 | Control Box AU-DC-EU Q-Logic |
| 263400925 | \$285.00 | Control Box AU-DC-EU Slave |



Note: AU-XX-EU Kits above include circuit board in box, 90cm cable harness. 120cm Water Sensor & Air Sensor 20' display cable with I/O kit only. No display or bezel included in kits, see Climate Controls and Electronics section.

AT High Velocity Air Handlers

| Item Number | List Price (USD) | Description |
|-------------|------------------|------------------------------|
| 261300007 | \$1,365.00 | AT4HVZ 4"MR 230V |
| 261301094 | \$3,970.00 | AT30HVZ-FC 8"MR 230V |
| 261300087 | \$3,860.00 | AT36HVZ 8"MR 230V |
| 261300287 | \$4,310.00 | AT36HVZ-2X1.5KW 8"MR 230V |
| 261300786 | \$4,020.00 | AT36HVZ-FC 8"MR 230V |
| 261300787 | \$4,470.00 | AT36HVZ-FC-2X1.5KW 8"MR 230V |

"Whisper Cool" AT-DC 36K Air Handlers

| | | |
|-----------|------------|------------------------------|
| 261300622 | \$4,915.00 | AT36DCZ-FC 8"MR 230V |
| 261300676 | \$5,365.00 | AT36DCZ-FC-2X1.5KW 8"MR 230V |



Chilled Water Air Handlers

ATL Draw-Through Air Handlers

| Item Number | List Price USD | Description |
|-------------|----------------|-----------------------------|
| 261301300 | \$2,640.00 | ATL6HVZ-FC 5"MR 230V |
| 261301302 | \$2,740.00 | ATL9HVZ-FC 6"MR 230V |
| 261301315 | \$3,190.00 | ATL9HVZ-FC 1.5KW 6"MR 230V |
| 261301304 | \$2,965.00 | ATL12HVZ-FC 6"MR 230V |
| 261301242 | \$3,265.00 | ATL18HVZ-FC 6"MR 230V |
| 261301318 | \$3,315.00 | ATL24HVZ-FC 8"MR 230V |
| 261301309 | \$3,755.00 | ATL24HVZ-FC 1.5KW 8"MR 230V |
| 261301310 | \$5,480.00 | ATL36HVZ-FC 8"MR 230V |
| 261301316 | \$3,455.00 | ATL9DCZ-FC 6"MR 230V |
| 261301317 | \$4,465.00 | ATL12DCZ-FC 6"MR 230V |
| 261300528 | \$2,820.00 | ATL16FZ 230V, sloped pan |
| 261301338 | \$4,455.00 | ATL18DCZ-FC 6"MR 230V |
| 261301313 | \$4,315.00 | ATL24DCZ-FC 8"MR 230V |



Note: Electric Heat is available on the ATLs, ATVs, and ABLs.

ABL Air Handlers

| Item Number | List Price USD | Description |
|-------------|----------------|-----------------------|
| 262110019 | \$4,450.00 | ABL18HVZ-FC 6"MR 230V |
| 262110012 | \$4,450.00 | ABL24HVZ-FC 6"MR 230V |
| 262110044 | \$5,695.00 | ABL18DCZ 6"MR 230V |
| 262110001 | \$6,010.00 | ABL24DCZ-FC 6"MR 230V |



ATV Vertical Draw-Through Air Handlers, with HV Blowers

| Item Number | List Price USD | Description |
|-------------|----------------|--------------------------------|
| 261301086 | \$2,240.00 | ATV6HV-SQ R180 5"MR 115V |
| 261301083 | \$2,270.00 | ATV9HV-SQ-R90 6"MR 115V |
| 261301082 | \$2,270.00 | ATV9HV-SQ-L90 6"MR 115V |
| 261301087 | \$2,270.00 | ATV9HV-SQ-R180 6"MR 115V |
| 261300554 | \$2,295.00 | ATV12HV-SQ L90 6"MR 115V |
| 261301085 | \$2,295.00 | ATV12HV-SQ R90 6"MR 115V |
| 261301134 | \$3,480.00 | ATV18HV-SQ-L90 7"MR 115V |
| 261301133 | \$4,200.00 | ATV24HV-SQ-R90 8"MR 115V |
| 261301080 | \$4,855.00 | ATV24HV-4P-LP-L90H 8"MR 115V |
| 261301154 | \$2,240.00 | ATV6HVZ-SQ 5"MR 230V |
| 261300567 | \$2,270.00 | ATV9HVZ-SQ-L90 6"MR 230V |
| 261300577 | \$2,270.00 | ATV9HVZ-SQ-R90 6"MR 230V |
| 261300552 | \$2,455.00 | ATV12HVZ-SQ-FC-L90 6"MR 230V |
| 261301207 | \$2,455.00 | ATV12HVZ-SQ-FC-R90 6"MR 230V |
| 261300565 | \$2,295.00 | ATV12HVZ-SQ-L90 6"MR 230V |
| 261300576 | \$2,295.00 | ATV12HVZ-SQ-R90 6"MR 230V |
| 261300542 | \$3,480.00 | ATV18HVZ-LP-L90 7"MR 230V |
| 261300575 | \$3,480.00 | ATV18HVZ-LP-R90 7"MR 230V |
| 261301034 | \$4,165.00 | ATV18HVZ-LP-FC-L90 2X1.0KW 7MR |
| 261300572 | \$4,200.00 | ATV24HVZ-LP L90 8"MR 230V |
| 261301165 | \$4,200.00 | ATV24HVZ-LP-R90 8"MR 230V |
| 261300566 | \$4,200.00 | ATV24HVZ-LP-36C-R90 8"MR 230V |
| 261301184 | \$4,550.00 | ATV24HVZ-LP-1.5KW L90 8"MR 230 |
| 261301201 | \$4,550.00 | ATV24HVZ-LP-1.5KW R90 8"MR 230 |
| 261301073 | \$4,650.00 | ATV24HVZ-LP-2X1.5KW L90 8"MR |



Chilled Water Air Handlers

ATV Vertical Draw-Through Air Handlers, with DC Blowers

| Item Number | List Price USD | Description |
|-------------|----------------|----------------------------------|
| 261301199 | \$3,135.00 | ATV9DCZ-LP-FC L90 6"MR 230V |
| 261301181 | \$3,325.00 | ATV9DCZ-LP-FC-1KW-L90 NOJBX 6"MR |
| 261300520 | \$3,235.00 | ATV12DCZ-SQ-FC L180 6"MR |
| 261301208 | \$3,585.00 | ATV12DCZ-LP-FC-1KW L90 6"MR |
| 261300550 | \$3,860.00 | ATV18DCZ-LP-FC-L90 7"MR 230V |
| 261301149 | \$4,310.00 | ATV18DCZ-LP-FC-R90 2X1KW 230V |
| 261301185 | \$5,190.00 | ATV24DCZ-SQFC-2X1.5KW-L90 8MR |
| 261301218 | \$6,100.00 | ATV36DCZ-LP-FC-1.5KW 8"MR 230V |



Fresh Air Makeup Air Handlers - with DC Blowers and Pulse Heat Control

| Item Number | List Price USD | Description |
|-------------|----------------|----------------------------------|
| 261400226 | \$4,560.00 | AU12DCZ-FC-RH-1.5KW-MU 6"MR 230V |
| 261400218 | \$4,740.00 | AU18DCZ-FC-2X1KW-MU 6"MR 230 |
| 261401097 | \$5,110.00 | AU24DCZ-FC-2X1KW-MU 8"MR 230V |
| 261300664 | \$6,660.00 | AT36DCZ-FC-2X1.5KW-MU 8"MR 230V |

Fresh Air Makeup Air Handlers - with pulse-heat control

| | | |
|-----------|------------|---------------------------------|
| 261400971 | \$3,935.00 | AU18HVZ-FC-1.5KW-MU 7"MR 230V |
| 261401135 | \$4,065.00 | AU24HVZ-FC-1.5KW-MU 8"MR 230V |
| 261301066 | \$5,850.00 | AT36HVZ-FC-2X1.5KW-MU 8"MR 230V |

Note: Above fresh air make-up units include pulse heat control and water valve.

Dometic Airhandler Control Package

| Item Number | List Price (USD) | Description |
|-------------|------------------|---------------------------------------------------------------------------------------------------------------------------|
| 263400938 | \$445.00 | DAHC Control Kit 115/230 HV -Includes control box with u-board, 7' water sensor and 10' air sensor. |
| 263400937 | \$770.00 | DAHC/CANBUS Kit 115/230 HV -Includes control box with u-board, 7' water sensor, 10' air sensor and Canbus adapter. |
| 263400940 | \$445.00 | DAHC Control Kit 115/230 DC -Includes control box with u-board, 7' water sensor and 10' air sensor. |
| 263400939 | \$770.00 | DAHC/CANBUS Kit 115/230 DC -Includes control box with u-board, 7' water sensor, 10' air sensor and Canbus adapter. |

Note: Display cable sold separately.

Chilled Water Air Handler and Blower Orientation

PROPRIETARY NOTE: THE INFORMATION CONTAINED WITHIN THIS DOCUMENT IS THE PROPERTY OF DOMETIC CORPORATION. ANY ATTEMPT TO COPY OR DISTRIBUTE WITHOUT WRITTEN CONSENT FROM DOMETIC CORPORATION SHALL BE CONSIDERED UNLAWFUL AND CAN BE CONTESTED IN A COURT OF LAW.

| REV | DATE | REVISION DESCRIPTION | DWG | APR |
|-----|---------|----------------------------------------------------|-----|-----|
| B | 4/16/02 | UPDATE PROPRIETARY NOTE, ADD REV BLK, CAD226-02 | DRR | JES |
| C | 7/15/04 | REMOVED 225° AND 270° REFERENCES, CAD474-04 | DRR | JES |
| D | 1/10/05 | MAKE DRAWING GENERIC FOR MAS & CRUISAIR, CAD029-05 | DRR | JES |
| | | | | |
| | | | | |

Air Handler discharge location will be indicated by an angle. The valve location will be indicated by an 'R' or an 'L'. For example: AT9HVZ R135. The 'R' means that the valve is on the right as one faces the coil. The '135' means that the blower is rotated 135 degrees counterclockwise as one faces the coil. Note that standard Air Handlers are 'L0' - the valve is on the left, and the blower is at zero degrees or pointing right as one faces the coil (see diagram). 'L0' will not appear in descriptions because it is the standard, all other orientations get full description. "NO VALVE" units still use "R" or "L" to indicate location of connections.

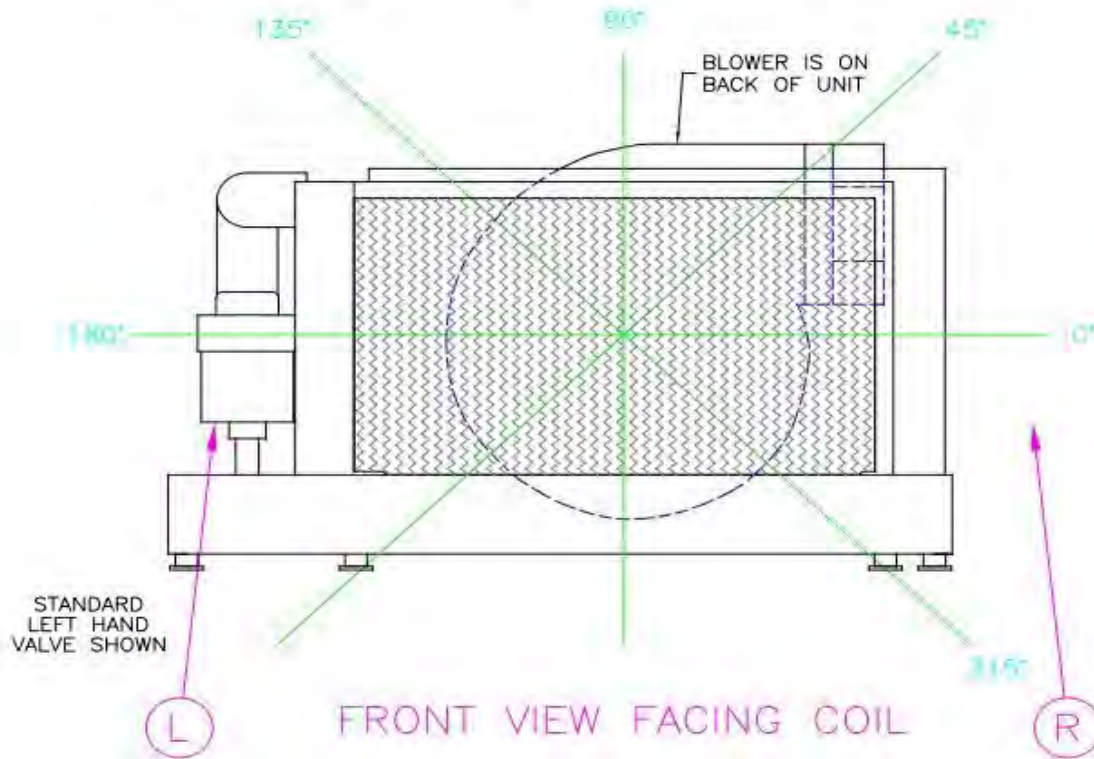

| CUSTOMER SIGN OFF |
|-------------------|
| |
| |
| |
| |
| |
| |

| | | | |
|-----------------------------------------------------------------------------------------------------|-------------|------------------|--------------|
| DOMETIC | | | |
| CUSTOM AIR HANDLERS - CUSTOMER SIGN OFF BLOWER ROTATION ANGLE & WATER VALVE LOCATION | | | |
| DATE: 12/10/98 | DWG BY: RMW | PART NUMBER: N/A | DWG H3050002 |
| SCALE: 1/6 | APR BY: E S | | REV D |

Climate Controls and Electronics

MARINE AIR AUTHORIZED DISTRIBUTORS & DEALERS ONLY

Display & Sensor Cables

| Item Number | List Price (USD) | Description |
|--------------------------------------------------------------------------------------------------------|------------------|------------------------------------------------------------|
| DISPLAY CABLE OPTIONS - VCD / CMCD / CSD | | |
| 331925 | \$24.00 | 10' Display Cable, 8-pin |
| 222103000 | \$33.00 | 15' Display Cable, 8-pin |
| 222103005 | \$80.00 | 20' Display Cable, 8-pin |
| 222103010 | \$85.00 | 25' Display Cable, 8-pin |
| 222103020 | \$80.00 | 30' Display Cable, 8-pin |
| 222103040 | \$110.00 | 35' Display Cable, 8-pin |
| 222103060 | \$105.00 | 40' Display Cable, 8-pin |
| 222103080 | \$115.00 | 45' Display Cable, 8-pin |
| 222103100 | \$130.00 | 50' Display Cable, 8-pin |
| 222103115 | \$130.00 | 60' Display Cable, 8-pin |
| WATER SENSORS | | |
| 334024 | \$41.00 | 2' Water Sensor |
| 331218 | \$45.00 | 7' Water Sensor |
| 331438 | \$65.00 | 10' Water Sensor |
| 331801 | \$70.00 | 15' Water Sensor |
| 333973 | \$75.00 | 20' Water Sensor |
| 332008 | \$85.00 | 25' Water Sensor |
| 332620 | \$90.00 | 30' Water Sensor |
| 333843 | \$95.00 | 35' Water Sensor |
| 333856 | \$100.00 | 40' Water Sensor |
| 334952 | \$110.00 | 45' Water Sensor |
| 334963 | \$120.00 | 50' Water Sensor |
| ALTERNATE AIR SENSOR OPTION - VTD / ECD / VCD / CMCD / CSD | | |
| 335887 | \$2.10 | Plastic clip to hold 7' alt air sensors above |
| 222102307 | \$45.00 | 7' Cable with Alternate Air Sensor attached & clip, 6-pin |
| 222102308 | \$70.00 | 15' Cable with Alternate Air Sensor attached & clip, 6-pin |
| 265100190 | \$95.00 | 30' Cable with Alternate Air Sensor attached & clip, 6-pin |
| 222102312 | \$115.00 | 40' Cable with Alternate Air Sensor attached & clip, 6-pin |
| 222102311 | \$250.00 | 75' Cable with Alternate Air Sensor attached & clip, 6-pin |
| IMPORTANT: REMOTE AIR SENSOR CARD MUST BE PURCHASED WITH ALL AIR SENSOR CABLES LISTED BELOW. | | |
| 1. Use when a return air temperature sensing location other than in display is needed. | | |
| 2. The air sensor is usually mounted in the return air stream. Clips are included as shown below. | | |
| 3. Do not mount on the drain pan, as the cold condensate water can lead to false temperature readings. | | |
| 222108009 | \$100.00 | Remote Air Sensor Card, 6-pin |
| 222102305 | \$42.00 | 7' Alternate Air Sensor Cable for Air Sensor Card, 6-pin |
| 222102310 | \$70.00 | 10' Alternate Air Sensor Cable for Air Sensor Card, 6-pin |
| 222102315 | \$75.00 | 15' Alternate Air Sensor Cable for Air Sensor Card, 6-pin |
| 222102320 | \$80.00 | 20' Alternate Air Sensor Cable for Air Sensor Card, 6-pin |
| 222102325 | \$85.00 | 25' Alternate Air Sensor Cable for Air Sensor Card, 6-pin |
| 222102330 | \$90.00 | 30' Alternate Air Sensor Cable for Air Sensor Card, 6-pin |
| 222102335 | \$95.00 | 35' Alternate Air Sensor Cable for Air Sensor Card, 6-pin |
| 222102340 | \$100.00 | 40' Alternate Air Sensor Cable for Air Sensor Card, 6-pin |
| 222102345 | \$105.00 | 45' Alternate Air Sensor Cable for Air Sensor Card, 6-pin |
| 222102365 | \$140.00 | 65' Alternate Air Sensor Cable for Air Sensor Card, 6-pin |
| OUTSIDE AIR SENSORS WITH CABLES FOR MONITORING OUTSIDE AIR TEMPERATURE. | | |
| 222102402 | \$85.00 | Outside Air Sensor w/ 7' cable, 6-pin |
| 222102405 | \$95.00 | Outside Air Sensor w/ 15' cable, 6-pin |
| 222102400 | \$115.00 | Outside Air Sensor w/ 25' cable, 6-pin |
| 222140330 | \$130.00 | Outside Air Sensor w/ 30' cable, 6-pin |
| 222102401 | \$155.00 | Outside Air Sensor w/ 40' cable, 6-pin |

Climate Controls and Electronics

CRUISAIR AUTHORIZED DISTRIBUTORS & DEALERS ONLY

| <u>Item Number</u> | <u>List Price (USD)</u> | <u>Description</u> |
|-----------------------------------------------|-------------------------|--------------------------------------------------------------------------|
| Control and Network Cables and Sensors | | |
| CXP CABLES | | |
| CXP5 | \$22.00 | Keypad to Box Cable, RJ12, 5 Feet |
| CXP10 | \$26.00 | Keypad to Box Cable, RJ12, 10 Feet |
| CXP15 | \$32.00 | Keypad to Box Cable, RJ12, 15 Feet |
| CXP20 | \$37.00 | Keypad to Box Cable, RJ12, 20 Feet |
| CXP30 | \$49.00 | Keypad to Box Cable, RJ12, 30 Feet |
| CXP40 | \$70.00 | Keypad to Box Cable, RJ12, 40 Feet |
| CXP60 | \$90.00 | Keypad to Box Cable, RJ12, 60 Feet |
| CXP80 | \$110.00 | Keypad to Box Cable, RJ12, 80 Feet |
| 722000001 | \$155.00 | Keypad to Box Cable, RJ12, 100 Ft |
| CNP REMOTE DISPLAY CABLES | | |
| CNP5 | \$55.00 | SMX Network Cable, RJ12, 5 Feet |
| CNP10 | \$55.00 | SMX Network Cable, RJ12, 10 Feet |
| CNP15 | \$70.00 | SMX Network Cable, RJ12, 15 Feet |
| CNP20 | \$80.00 | SMX Network Cable, RJ12, 20 Feet |
| CNP40 | \$100.00 | SMX Network Cable, RJ12, 40 Feet |
| CNP60 | \$120.00 | SMX Network Cable, RJ12, 60 Feet |
| ADAPTERS, ETC. | | |
| 4163804 | \$26.00 | Adapter, 3-Pin Socket (TSE) to RJ11 Male Plug (A-288C, A-282NC) |
| 4163805 | \$26.00 | Adapter, 4-Pin Socket (CX) to RJ12 Male Plug (SMXir/ht, A-288C, A-282NC) |
| 4106409 | \$8.57 | Modular Coupling, TSEP, CXP, CNP |
| 763100043 | \$80.00 | A-913,Adapter,RJ12Socket(CXP)to 4-Pin Male Plug (SMXiiAB,A-281C,Old Net) |
| 763100044 | \$80.00 | A-914, Adapter, RJ11 Socket (TSEP) to 3-Pin Male Plug (A-281C, Old Net) |
| TEMPERATURE/HUMIDITY SENSORS | | |
| 334498 | \$39.00 | TSEP5, Temperature Sensor, RJ11, 5 Feet |
| TSEP10 | \$42.00 | Temperature Sensor, RJ11, 10 Feet |
| TSEP15 | \$47.00 | Temperature Sensor, RJ11, 15 Feet |
| TSEP20 | \$50.00 | Temperature Sensor, RJ11, 20 Feet |
| TSEP30 | \$65.00 | Temperature Sensor, RJ11, 30 Feet |
| TSEP40 | \$75.00 | Temperature Sensor, RJ11, 40 Feet |
| TSEP60 | \$90.00 | Temperature Sensor, RJ11, 60 Feet |
| TSEP80 | \$100.00 | Temperature Sensor, RJ11, 80 Feet |
| 4062325 | \$23.00 | Seawater Sensor DX Q-Logic |
| 722400008 | \$190.00 | Temperature Sensor/Relative Humidity Q-Logic 15ft |
| 722400013 | \$250.00 | Temperature Sensor/Relative Humidity Q-Logic 35ft |
| 297000049 | \$175.00 | Temperature Sensor Well, 1"NPT Plug, Copper |
| 4250046 | \$250.00 | Break Out Cable Temp/Rel. Humid. Q Logic Fresh Air Make-up |
| 4062331 | \$48.00 | Water Temperature Sensor, Q-Logic 5 Feet |
| 4062332 | \$70.00 | Water Temperature Sensor, Q-Logic 10 Feet |
| 4062334 | \$100.00 | Water Temperature Sensor, Q-Logic 30 Feet |

Cruisair Climate Controls and Accessories

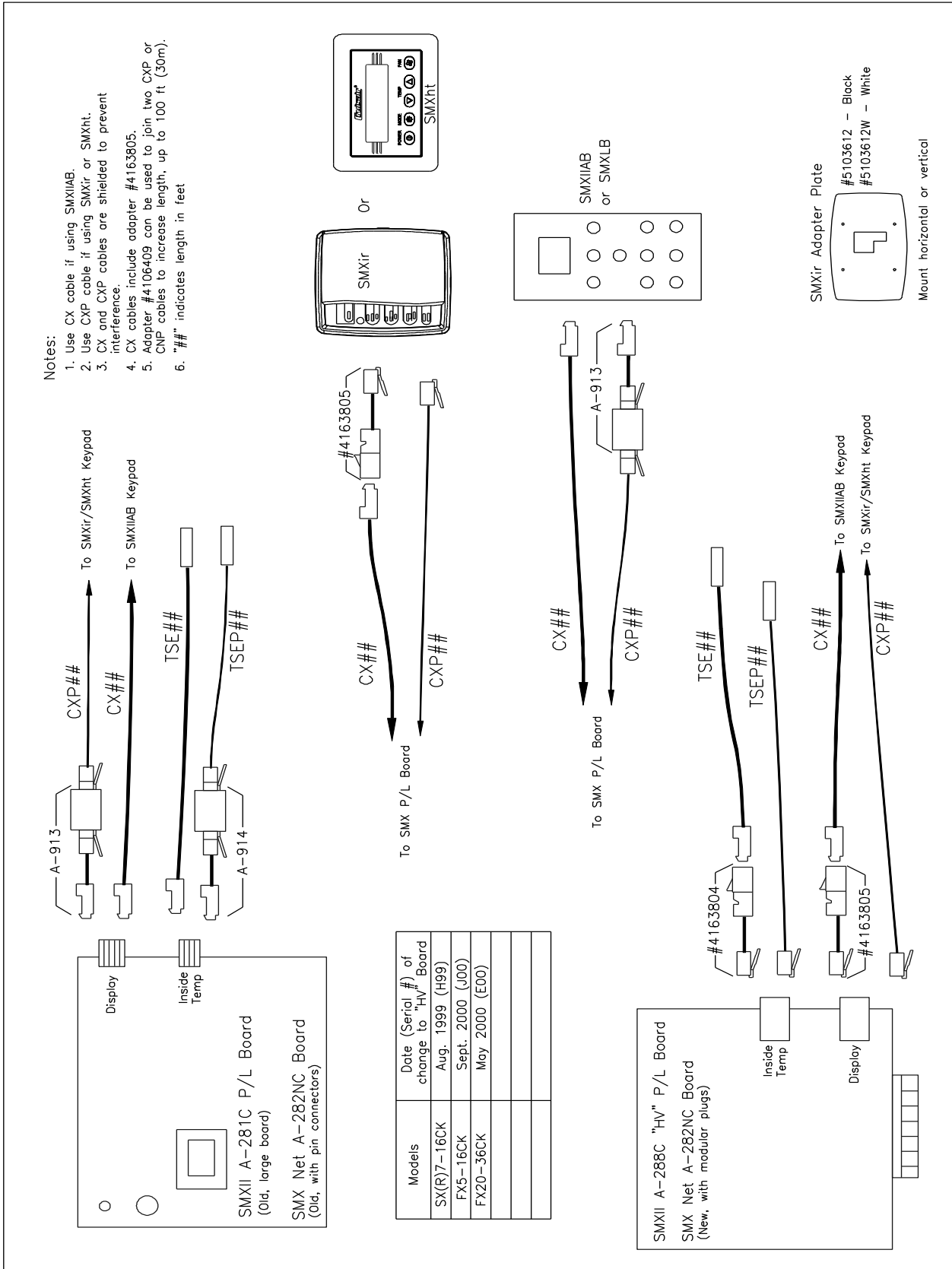

Climate Controls and Electronics

CRUISAIR AUTHORIZED DISTRIBUTORS ONLY

| Item Number | List Price (USD) | Description |
|------------------------------------------------------|------------------|---------------------------------------------------------------------|
| Cruisair Q Logic Displays | | |
| 722200250 | \$190.00 | Display Q3 Marine DX Black |
| 722200260 | \$190.00 | Display Q3 Marine TW Black |
| 722200200 | \$230.00 | Display QHT Marine DX & TW Gray |
| 722200210 | \$230.00 | Display QHT Marine DX & TW White |
| 722200201 | \$255.00 | Display QHT Eikon DX & TW Gray |
| Cruisair SMX Displays | | |
| 722200000 | \$260.00 | Display SMXHT DX Gray |
| 722200020 | \$260.00 | Display SMXHT DX White |
| 722200010 | \$255.00 | Display SMXHT TW Gray |
| 722200030 | \$255.00 | Display SMXHT TW White |
| SMXIRB | \$280.00 | Display SMXIR 3/4 Door DX Black |
| SMXIRW | \$280.00 | Display SMXIR 3/4 Door DX White |
| SMXIR-REM | \$90.00 | Control Remote SMXIR DX |
| SMXIRB-T | \$295.00 | Display SMXIR 3/4 Door TW Black |
| SMXIRW-T | \$295.00 | Display SMXIR 3/4 Door TW White |
| 297000045 | \$300.00 | Display SMXIR Full Door DX Black |
| 297000052 | \$300.00 | Display SMXIR Full Door DX White |
| SMXIIAB | \$260.00 | Display SMXII DX Black |
| SMXIIIB | \$255.00 | Display SMXII TW Black |
| Cruisair TWLC Display | | |
| 335504 | \$440.00 | Display TWLC LCD |
| Cruisair Mechanical Controls, Rotary Switches | | |
| 763100047 | \$580.00 | SSA3-ZB, 3-Knob Switch, Black, 10' Cable w/Plug, 115V |
| 763100046 | \$580.00 | SSA3-ZCB, 3-Knob Switch, Black, 10' Cable w/Plug, 230V |
| 763100090 | \$605.00 | SSA3-ZHB, 3-Knob Switch, Horizontal, Black, 10' Cable w/Plug, 115V |
| 763100069 | \$605.00 | SSA3-ZHCB, 3-Knob Switch, Horizontal, Black, 10' Cable w/Plug, 230V |
| 763100059 | \$590.00 | TS3-ZCB1, 3-Knob Switch, Black, 10' Cable 230V w/COS |
| Cruisair Rotary Switches for Remote Units | | |
| 763100045 | \$545.00 | SA3-ZB10, 3-Knob Switch, Black, 10' Cap Tube, 115V |
| 763100073 | \$545.00 | SA3-ZCB10, 3-Knob Switch, Black, 10' Cap Tube, 230V |
| 763100055 | \$520.00 | SA3-BB10, 3-Knob Switch, Black, 10' Cap Tube, 2-Speed Blower, 115V |
| 763100075 | \$545.00 | SA3-ZHB10, 3-Knob Switch, Horizontal, Black, 10' Cap Tube, 115V |
| 763100068 | \$545.00 | SA3-ZHCB10, 3-Knob Switch, Horizontal, Black, 10' Cap Tube, 230V |
| Cruisair Rotary Switches for Slave Units | | |
| 763100063 | \$250.00 | SA4-ZB, 1-Knob Fan Speed Cont., Black, 115V |
| 763100048 | \$250.00 | SA4-ZCB, 1-Knob Fan Speed Cont., Black, 230V |
| 763100051 | \$335.00 | SA4A-ZB, 2-Knob, On/Auto, Fan Speed Cont., Black, 115V |
| 763100042 | \$335.00 | SA4A-ZCB, 2-Knob, On/Auto, Fan Speed Cont., Black, 230V |
| Cruisair Retrofit Kits | | |
| 705600011 | \$530.00 | Retro SMXII P/L ONLINE > NET-U |
| 705600010 | \$455.00 | Retro 3 Knob > SMXII/Q-Logic > U-Board |



SMX Displays



Climate Controls and Electronics

MARINE AIR AUTHORIZED DISTRIBUTORS ONLY

| Item Number | List Price (USD) | Description | |
|----------------------------------------------------------------------------------------------------------------------------------------------|------------------|-----------------------------------------------------|-------------------------------------------------------------------------------------------------------------------------------------------|
| Marine Air Smart Touch | | | |
| 222200400 | \$295.00 | Display Smart Touch Eikon |  Smart Touch |
| Marine Air Elite Displays | | | |
| 222000210 | \$235.00 | Display Only Elite Gray DX & CW |  Elite Elite Eikon |
| 222000211 | \$235.00 | Display Only Elite White DX & CW | |
| 222000216 | \$255.00 | Display Only Elite II Eikon Gray DX & CW | |
| Marine Air Passport I/O Displays | | | |
| 222000200 | \$225.00 | Display w/Bezel Compact Passport I/O Black DX & CW |  Passport I/O |
| 222000201 | \$225.00 | Display w/Bezel Compact Passport I/O White DX & CW | |
| 222000220 | \$225.00 | Display Only Compact Passport I/O Black DX | |
| 222000221 | \$225.00 | Display Only Compact Passport I/O White DX | |
| Marine Air Chilled Water Controls | | | |
| 334619 | \$610.00 | Display CWMC Black |  CWMC Display |
| 331217 | \$1,000.00 | Display Hydromatic Black | |
| Marine Air Mechanical Control, Rotary Switches | | | |
| Reverse Cycle Self-Contained 3-Knob Control Panel (Vector Compact, Turbo Mechanical or Cabin Mate) | | | |
| 222110030 | \$495.00 | Black MCP Control, Self-Cont, Horizontal, 115 Volts |  Single Knob 3 Knob Control Slave Control |
| 223110054 | \$495.00 | Black MCP Control, Self-Cont, Horizontal, 230 Volts | |
| 222110033 | \$495.00 | Black MCP Control, Self-Cont, Vertical, 115 Volts | |
| 223110055 | \$495.00 | Black MCP Control, Self-Cont, Vertical, 230 Volts | |
| Reverse Cycle Central Systems 3-Knob Control Panel | | | |
| 223110083 | \$580.00 | Black MCP Control, Central, Horizontal, 230 Volts | |
| 223110090 | \$580.00 | Black MCP Control, Central, Vertical, 230 Volts | |
| Back Cover for MCP | | | |
| 223200000 | \$55.00 | MCP back cover, ABS plastic | |
| Cool Only 2-Knob Control Panel | | | |
| 222110102 | \$360.00 | MCP 2-Knob ECM Vertical, 115/230V | |
| MECHANICAL SLAVE CONTROLS | | | |
| Slave Controls - To be used to control fan speed when an extra evaporator is wired to another evaporator which has a complete control panel. | | | |
| 222110044 | \$250.00 | Slave Control Black, 115 Volt | |
| 223110067 | \$250.00 | Slave Control Black, 230 Volt | |

Climate Controls and Electronics

MARINE AIR AUTHORIZED DISTRIBUTORS ONLY

Digital Upgrade Retrofit Kits

| Item Number | List Price (USD) | Description |
|-------------|------------------|-------------|
|-------------|------------------|-------------|

SELF-CONTAINED 3-KNOB UPGRADE TO ELITE OR PASSPORT I/O

| | | |
|-----------|----------|-----------------------------------------------------------------|
| 222108000 | \$42.00 | Retro Plate for 3 Knob to Passport I/O, Black (included in kit) |
| 222108001 | \$42.00 | Retro Plate for 3 Knob to Passport I/O, White (included in kit) |
| 223100261 | \$755.00 | Retrofit Kit, Self-Contained Elite Gray Vertical |
| 223100262 | \$735.00 | Retrofit Kit, Self-Contained Passport I/O, Black |
| 223100263 | \$735.00 | Retrofit Kit, Self-Contained Passport I/O, White |

Note: Includes I/O control inside elec. box, harness with polarized plug, display, retrofit plate, black poly bezel (with Elite only), 15' display cable, 7' air sensor, manual, and quick reference card.

CENTRAL SYSTEM 3-KNOB UPGRADE TO ELITE OR PASSPORT I/O

| | | |
|-----------|----------|--------------------------------------------------|
| 223100212 | \$745.00 | Retrofit Kit, Central System Passport I/O, Black |
| 223100213 | \$745.00 | Retrofit Kit, Central System Passport I/O, White |

Note: Includes I/O control inside elec. box, harness, display, retrofit plate, black poly bezel (with Elite only), 30' display cable, 7' air sensor, manual, and quick reference card.

ECU MAXX DISPLAY RETROFIT PLATE TO ELITE OR PASSPORT I/O

| | | |
|-----------|----------|-------------------------------------------------------|
| 293600431 | \$65.00 | Retrofit Plate, ECU MAXX to Passport I/O Black |
| 293600443 | \$85.00 | Retrofit Plate, ECU MAXX to Elite Black Horizontal |
| 223100420 | \$665.00 | Retrofit Kit ECU MAXX to Passport Elite - Black Bezel |
| 223100422 | \$680.00 | Retrofit Kit ECU MAXX to Passport I/O - Black Bezel |
| 223100423 | \$655.00 | Retrofit Kit ECU MAXX to Passport I/O - White Bezel |

Note: Includes display retrofit plate only.

ECU UPGRADE TO ELITE OR PASSPORT I/O

| | | |
|-----------|----------|-------------------------------------------|
| 223100222 | \$670.00 | Retrofit Kit, ECU to Passport I/O - Black |
| 223100223 | \$655.00 | Retrofit Kit, ECU to Passport I/O - White |

Note: Includes I/O control, PP I/O module retrofit plate, display, 15' display cable, 7' air sensor, manual, and quick reference card. (Elite includes display retrofit plate and black poly bezel.)

PASSPORT UPGRADE TO ELITE OR PASSPORT I/O

| | | |
|-----------|----------|------------------------------------------------|
| 223100232 | \$655.00 | Retrofit Kit, Passport to Passport I/O - Black |
| 223100233 | \$655.00 | Retrofit Kit, Passport to Passport I/O - White |

Note: Includes I/O control, PP I/O module retrofit plate, display, manual, & quick reference card. (Elite includes display retrofit plate and black poly bezel.)

PASSPORT II UPGRADE TO ELITE OR PASSPORT I/O

| | | |
|-----------|----------|---------------------------------------------------|
| 223100224 | \$680.00 | Retrofit Kit, Passport II to Elite - Gray |
| 223100226 | \$650.00 | Retrofit Kit, Passport II to Passport I/O - Black |
| 223100227 | \$655.00 | Retrofit Kit, Passport II to Passport I/O - White |

Note: Includes I/O control, display, manual, & quick reference card. (Elite includes display retrofit plate and black poly bezel.)

ELITE RETROFIT COVER PLATES

| | | |
|-----------|---------|--------------------------------------------------------------------|
| 293600422 | \$95.00 | Retrofit Plate, MCP 3-Knob to Elite Horizontal, White |
| 293600423 | \$95.00 | Retrofit Plate, MCP 3-Knob to Elite Vertical, White |
| 293600424 | \$95.00 | Retrofit Plate, MCP 3-Knob to Elite Horizontal, Black |
| 293600444 | \$95.00 | Retrofit Plate, MCP 3-Knob to Elite Vertical, Black |
| 293600455 | \$95.00 | Retrofit Plate, Passport II to Elite Horizontal or Vertical, Black |

Climate Controls and Electronics

DOMETIC DISPLAYS

| Item Number | List Price (USD) | Description |
|--------------------------------------------------|------------------|-----------------------------------------|
| Dometic EnviroCool/EnviroComfort Display | | |
| 222000226 | \$230.00 | Display Only Dometic I/O Black (ECD) |
| Dometic Programmed Logic Control | | |
| 338086 | \$300.00 | PLDPro Small PLC Display DOMETI C |
| 339048 | \$555.00 | PGD1 Blk Remote PLC Display DOMETIC |
| 337419 | \$555.00 | PGD1 Wht Remote PLC Display DOMETIC |
| 337995 | \$70.00 | Splitter for multiple displays |
| Dometic Smart Touch Chilled Water Control | | |
| 263150137 | \$1,970.00 | PGD Touch Screen 7" Flush for Chiller |
| 263150138 | \$2,000.00 | PGD Touch Screen 7" Flush for VARC48 |
| 263150140 | \$2,000.00 | PGD Touch Screen 7" Flush for STIIC |
| 263150139 | \$4,850.00 | PGD Touch Screen 13" Flush for Chiller |
| 337046 | \$105.00 | Cable 9 Pin to 3 Pin for 13" display |
| Dometic Eskimo Ice Display | | |
| 252000150 | \$180.00 | Display Only Dometic Digital Eskimo Ice |



Bezels & Keypad Accessories

| Item Number | List Price (USD) | Description |
|-------------|------------------|-----------------------------------------------------------|
| 337173 | \$90.00 | Bezel Bright Varnished Metal Eikon Matte Anthracite |
| 336562 | \$25.00 | Bezel Poly Eikon Graphite Gray |
| 335441 | \$17.00 | Bezel Poly Black Elite & Q Control |
| 335442 | \$17.00 | Bezel Poly Idea White Elite & Q Control |
| 335443 | \$17.00 | Bezel Poly Graphite Gray Elite & Q Control |
| 335444 | \$60.00 | Bezel Metal Black Chrome |
| 335440 | \$65.00 | Bezel Metal Polished Gold |
| 4220012 | \$70.00 | Bezel Metal Polished Chrome Rondo 3M |
| 335446 | \$60.00 | Bezel Metal Bronze |
| 335448 | \$55.00 | Bezel Metal Ivory |
| 335449 | \$55.00 | Bezel Metal White |
| 335511 | \$17.00 | Bezel Poly Classica Idea White |
| 335512 | \$17.00 | Bezel Poly Classica Graphite gray |
| 335513 | \$55.00 | Bezel Metal Classica White |
| 335516 | \$55.00 | Bezel Metal Classica Black |
| 335514 | \$65.00 | Bezel Metal Classica Polished Gold |
| 222000224 | \$20.00 | Bezel Adapter Passport I/O Black |
| 222000225 | \$20.00 | Bezel Adapter Passport I/O White |
| 228710002 | \$13.00 | Adapter Bulkhead Passport Display Black |
| 5101405 | \$70.00 | Plate SMXII Snap-On Cover, Black TW |
| 5101401 | \$47.00 | PXB, SMX II Keypad Plate, Snap-on, Black |
| 5101501 | \$47.00 | PXW, SMX II Keypad Plate, Snap-on, White |
| 5103400 | \$90.00 | Full Door for SMXir Display- Black |
| 5103400W | \$90.00 | Full Door for SMXir Display- White |
| 5103300 | \$24.00 | 3/4 Door for SMXir Display- Black |
| 5103300W | \$24.00 | 3/4 Door for SMXir Display- White |
| 5103612 | \$30.00 | Retrofit Wall Adapter Plate, SMXII/3-Knob to SMXir, Black |
| 5103612W | \$150.00 | Retrofit Wall Adapter Plate, SMXII/3-Knob to SMXir, White |
| 5103200 | \$17.00 | Mounting plate for SMXir, Black |

PUMPS

NOMENCLATURE

P 0 3 5 S - 1 1 7 1 D - 2 5 0 - 1/3 T

P = Pump
PA = Pump Assembly

Flow Rate in GPM
035 = 35 GPM
380 = 380 GPM
060 = 60 GPM
112 = 112 GPM

S = Seawater/Chilled Water duty
C = Chilled Water use only
R = Seawater w/ Self Priming Reservoir

Voltage Code
1151 = 110V-220V 50-60Hz 1ph
1161 = 115V 60Hz 1ph
1171 = 110V-115V 50-60Hz 1ph
2251 = 220V 50Hz 1ph
2361 = 230V 60Hz 1ph
2363 = 230V 60Hz 3ph
2053 = 200V 50Hz 3ph
2371 = 230V 50-60Hz 1ph
2373 = 230V 50-60Hz 3ph
3853 = 380V 50Hz 3ph
4053 = 400V 50Hz 3ph
4663 = 460V 60Hz 3ph
4673 = 460V 50-60Hz 3ph

T = TEFC motor
D = ODP motor
I = IEEE

Nominal Motor HP
-1/3 = 1/3hp
-1/2 = 1/2hp
-1.0 = 1hp
-3.0 = 3hp
-5.0 = 5hp
-7.5 = 7hp
-10 = 10hp

Impeller size in inches
-250 = 2.50"

D = Dual Voltage Motor
Blank = Motor is only rated for voltage listed

PUMPS

PUMP ASSEMBLIES AND PUMP PACKAGES

| New Part Number | List Price USD | New Description | Seal Kit | Impeller # | Old Part Number/Ref # |
|-----------------|----------------|---------------------------------------------------------------|----------|------------|--------------------------------------------------|
| P060 | | | | | |
| 225480010 | \$ 2,020.00 | PUMP ASY P060S-2373D-275-1/2D | 337428 | | 225500026 225500071 |
| 225480011 | \$ 2,020.00 | PUMP ASY P060S-2373D-350-1/2D | 337428 | | 225500012 |
| 225480012 | Call for Price | PUMP PNTC P060S-2373D-350-1/2D | 337428 | | 225500062 |
| 225480013 | Call for Price | PUMP ASY P060S-2053D-375-1/2T | 337428 | | 225500011 |
| 225480026 | \$ 2,030.00 | PUMP ASY P060S-2373D-400-1/2D | 337428 | | 225500314 |
| P102 | | | | | |
| 225480005 | \$ 3,150.00 | PUMP PNTC P102S-1171R-441-3/4D 1.5X1.5 | 337428 | | 225500275 |
| 225480015 | \$ 2,800.00 | PUMP ASY P102S-1171R-441-3/4D | 337428 | | 225500280 |
| 225480014 | \$ 3,175.00 | PUMP ASY P102S-1171R-441-3/4T | 337428 | | 225500290 |
| 225480023 | \$ 3,520.00 | PUMP ASY P102R-2373D-441-3/4D | 337428 | | 225500315 |
| P112 | | | | | |
| 225480002 | \$ 2,000.00 | PUMP ASY P112S-1171D-350-1/2D | 337428 | | 225500059 |
| 260115509 | \$ 3,700.00 | PMP PKG P112S-1171D-350-1/2D W/DTSCH W/EXP TANK | 337428 | | 260115033 |
| 260115501 | \$ 3,625.00 | PMP PKG P112S-1171D-350-1/2D W/EXP TANK | 337428 | | 260110514 |
| 225480016 | \$ 2,100.00 | PUMP ASY P112S-2373D-350-1/2D | 337428 | | 225500028 225500082 |
| 260115503 | Call for Price | PMP PKG P112S-2373D-350-1/2D W/EXP TANK | 337428 | | 260110527 |
| 225480017 | Call for Price | PUMP ASY PNTD P112S-2373D-350-1/2D | 337428 | | 225500133 |
| 225480018 | \$ 2,100.00 | PUMP ASY P112S-1171D-375-3/4T | 337428 | | 225500291 |
| 225480019 | \$ 2,200.00 | PUMP ASY P112S-2373D-375-3/4D | 337428 | | 225500292 |
| 225480008 | \$ 2,100.00 | PUMP ASY P112S-2251-400-3/4T 1.5"X1.5" IGNITION PROTECTED | 337428 | | 225500033 |
| 260115504 | \$ 3,900.00 | PMP PKG P112S-2251-400-3/4T | 337428 | | 260110524 225500031 225500032 225500041 |
| 225480007 | \$ 2,300.00 | PUMP ASY P112S-2253D-400-3/4T 1.5"X1.5" IGNITION PROTECTED | 337428 | | 225500031 225500032 225500041 |
| TBD | Call For Price | PMP PKG P112S-2253D -400-3/4T | | | 260110524 |
| 225480001 | \$ 2,200.00 | PUMP ASY P112S-1171D-400-1.0D 1.5"X1.5" | 337428 | | 225369928 |
| 260115506 | \$ 4,310.00 | PMP PKG P112S-1171D-400-1.0D W/EXP TANK | 337428 | | 260110521 |
| 260115507 | \$ 4,310.00 | PMP PKG P112S-2361D-400-1.0D VERT DSCH W/EXP TANK | 337428 | | 260110523 |
| 225480020 | \$ 2,300.00 | PUMP ASY P112S-2373D-400-1.0D | 337428 | | 225500083 |
| 225480022 | \$ 2,400.00 | PUMP ASY P112S-2251D-425-1.0T 1.5"X1.5" | 337428 | | 225500287 |
| 225480009 | \$ 2,500.00 | PUMP ASY P112S-1161D-425-1.5D | 337428 | | 225500121 |
| 260115500 | \$ 4,315.00 | PMP PKG P112S-1161D-425-1.5D W/EXP TANK | 337428 | | 260110533 |

PUMPS

PUMP ASSEMBLIES AND PUMP PACKAGES CONTINUED

| New part number | List Price USD | New Description | Seal Kit | Impeller # | Old Part Number |
|-----------------------------|----------------|---------------------------------------------------------------|----------|------------|-----------------|
| 225480024 | \$ 2,500.00 | PUMP ASY P112S-2251D-425-1.5T | 337428 | | 225500121 |
| 260115508 | Call for Price | PMP PKG P112S-2251D-425-1.5T W/EXP TANK | 337428 | | 260110533 |
| 225480004 | \$ 2,200.00 | PUMP ASY P112S-2053D/460-1.0D | 337428 | | 225500211 |
| 225480006 | \$ 2,500.00 | PUMP ASY P112S-1171D-450-1.5T 1.5"X1.5" IGNITION PROTECTED | 337428 | | 225500338 |
| 260115502 | \$ 4,740.00 | PMP PKG P112S-1171D-450-1.5T W/EXP TANK | 337428 | | 260110532 |
| 225480025 | \$ 2,705.00 | PUMP ASY P112S-2373D-450-2.0D | 337428 | | 225500307 |
| 225480021 | \$ 2,750.00 | PUMP ASY P112S-2251D-475-1.5T 1.5"X1.5" | 337428 | | 225500334 |
| 260115510 | \$ 4,980.00 | PUMP PKG P112S-2251D-475-1.5T W/EXP TANK | 337428 | | 260110520 |
| 225480003 | \$ 2,500.00 | PUMP ASY P112S-2053D-475-1.5D 1.5"X1.5" | 337428 | | 225500030 |
| 260115505 | Call for Price | PMP PKG P112S-2053D-475-1.5D W/EXP TANK | 337428 | | 260110526 |
| MARCH/FRANKLIN PUMPS | | | | | |
| 225500004 | \$ 420.00 | PUMP ASY PML250 115/50-60/1- | | | LC-2CP-MD 115V |
| 225500226 | \$ 420.00 | PUMP ASY PML250 115V NO FITTINGS | | | LC-2CP-MD 115V |
| 225500014 | \$ 430.00 | PUMP ASY PML250C 230/50-60/1- | | 051701 | LC-2CP-MD 230V |
| 225500227 | \$ 430.00 | PUMP ASY PML250C 230V NO FITTINGS | | 051701 | LC-2CP-MD 230V |
| 225500005 | \$ 510.00 | PUMP ASY PML500 115/50-60/1 | | 330118 | LC-3CP-MD 115V |
| 225500016 | \$ 545.00 | PUMP ASY PML500C 50-60HZ/1 | | 330118 | LC-3CP-MD 230V |
| 225500064 | \$ 525.00 | PUMP ASY PMA500 115V/60 3/4"IN | | 330118 | |
| 225500068 | \$ 535.00 | PUMP ASY PMA500C 230/60/1 3/4I | | 330118 | |
| 225500067 | \$ 535.00 | PUMP ASY PMA500CK 220/50/1 | | 330118 | |
| 225500065 | \$ 600.00 | PUMP ASY PMA1000 115/50-60 3/4 | | 334080 | AC-5C-MD 115V |
| 225500069 | \$ 620.00 | PUMP ASY PMA1000C 230/50-60/1 | | 334080 | AC-5C-MD 230V |
| 225500276 | \$ 1,200.00 | PUMP PML1000 SUBMERSIBLE 115V | | 334080 | LC-5C-MD 115 V |
| 225500288 | \$ 1,225.00 | PUMP PML1000C SUBMERSIBLE 230V | | 334080 | LC-5C-MD 230 V |
| P100/P120/P700/P715 | | | | | |
| 225500001 | \$ 1,350.00 | PUMP ASY P100 1161 1/3HP 2.5" | 333990 | 333992 | 67 |
| 225500072 | \$ 1,350.00 | PUMP ASY P100Z 2371 1/3HP 2.5" | 333990 | 333992 | 67 |
| 225500102 | \$ 1,370.00 | PUMP ASY P120 2371 1/3HP 3" | | | 67 |
| 225500066 | \$ 1,325.00 | PUMP ASY P700Z 2371 1/3" 3.5" | | | 67 |
| 225500154 | \$ 3,950.00 | PUMP ASY P715CW 2373 1.5HP 4" | | | 17 |
| 225500159 | \$ 4,200.00 | PUMP ASY P715CW 2373 2HP 4.5" | | | 17 |
| 225500161 | \$ 4,250.00 | PUMP ASY P715CW 2253/3853 2HP 4.75" | | | 17 |
| 225500165 | \$ 5,275.00 | PUMP ASY P715CW 2253/3853 3HP 4.75" | | | 121 |
| 225500135 | \$ 4,450.00 | PUMP ASY P715SW 2373 1.5HP 4" | | | 162 |
| 225500138 | \$ 4,550.00 | PUMP ASY P715SW 3853 1.5HP 4.5" | | | 182 |
| 225500142 | \$ 5,000.00 | PUMP ASY P715SW 2253/3853 2HP 4.75" | | | 162 |
| 225500162 | \$ 5,450.00 | PUMP ASY P715CW 2363 3HP 4.5" | | | 206 |
| 225500169 | \$ 6,050.00 | PUMP ASY P715CW 3853 5HP 5.13" | | | 206 |
| PRIMETIME PUMPS | | | | | |
| 225500346 | \$ 1,225.00 | PUMP DP-PT 115V 50/60HZ 4'CORD | | | |
| 225500348 | \$ 1,225.00 | PUMP DP-PT 230V 50/60HZ 4'CORD | | | |

PUMPS

Circulated Water Pump Packages

****With diaphragm-style expansion tanks****

| Item No. | List Price (USD) | Description |
|-----------|------------------|--------------------------------------|
| 260110515 | \$2,275.00 | Pump Pkg PMA1000, tank, 115/60/1 |
| 260110516 | \$2,325.00 | Pump Pkg PMA1000C, tank, 230/50-60/1 |
| 260110517 | \$2,425.00 | Pump Pkg PMA1000CK, tank 240/50/1 |
| 260110519 | \$2,985.00 | Pump Pkg P120Z, tank, 230/50-60/1 |
| 260110512 | \$3,035.00 | Pump Pkg P700Z, tank, 230/50-60/1 |

Note: Includes pump, drain pan, fill assembly w/press, regulator, expansion tank, gauge, and hosebarbs.

Pump Accessories

| Item Number | List Price (USD) | Description |
|------------------------------|------------------|-------------------------------------------------------|
| SEAWATER STRAINERS | | |
| 332784 | \$75.00 | Seawater Strainer, 3/4" FPT, Plastic Housing |
| 1011100 | \$305.00 | ST3/4N, Seawater Strainer, 3/4" FPT, Groco |
| 1011200 | \$395.00 | ST1N, Seawater Strainer, 1" FPT, Groco |
| 1011300 | \$450.00 | ST1-1/4N, Seawater Strainer, 1-1/4" FPT, Groco |
| THROUGH-HULL FITTINGS | | |
| 1050800 | \$105.00 | STH3/4, Scoop Type Through-Hull, Bronze, 3/4" MPT |
| 1049900 | \$160.00 | STH1-1/4, Scoop Type Through-Hull, Bronze, 1-1/4" MPT |
| 1051800 | \$70.00 | Flush Overboard Through-Hull, Bronze, 3/4" MPT |
| 1054100 | \$38.00 | Fitting Thru-Hull Plastic 1/2" MPT X 5/8" Hose |
| BALL VALVES | | |
| 330868 | \$80.00 | BV3/4, Ball Valve, Bronze & Stainless, 3/4" FPT |
| 1060600 | \$135.00 | Ball Valve, Bronze , 1" FPT |
| 1060700 | \$175.00 | Ball Valve, Bronze , 1 1/4" FPT |
| HOSE BARBS/ADAPTERS | | |
| 361040 | \$8.57 | Brass Hose Barb, 1/2" MPT x 5/8" (16mm) HB |
| 361080 | \$13.00 | Brass Hose Barb, 3/4" MPT x 3/4" (19mm) HB |
| 361060 | \$25.00 | Brass Hose Barb, 1" MPT x 1" (25mm) HB |
| 1011700 | \$17.00 | Adapter Bronze 1/2" MPT X 5/8" Hose |
| 1011600 | \$18.00 | Adapter Bronze 3/4" MPT X 3/4" Hose |
| 335080 | \$8.40 | Adapter PVC 1/2" FPT X 5/8" Hose #1435-005 |
| 1054200 | \$4.28 | Adapter PVC 1/2" MPT X 5/8" Hose |
| 1054700 | \$6.62 | Adapter PVC 90° Elbow 1/2" FPT X 5/8" Hose |
| 335380 | \$6.30 | Adapter PVC 90° Elbow 1/2" MPT X 5/8" Hose |
| 1055700 | \$17.00 | Adapter PVC 3/4" FPT X 3/4" Hose |
| 1054400 | \$8.74 | Adapter PVC 3/4" MPT X 5/8" Hose |
| 335230 | \$3.15 | Adapter PVC 3/4" MPT X 3/4" Hose |
| 335350 | \$7.65 | Adapter PVC 3/4" MPT X 1" Hose |
| 1056000 | \$11.00 | Adapter PVC 90° Elbow 3/4" MPT X 3/4" Hose |
| 1056700 | \$13.00 | Adapter PVC 90° Elbow 3/4" FPT X 1" Hose |
| 335340 | \$5.25 | Adapter PVC 1" MPT X 3/4" Hose |
| 1053600 | \$18.00 | Adapter PVC 1" FPT X 1" Hose |
| 335200 | \$4.28 | Adapter PVC 1" MPT X 1" Hose |
| 1056800 | \$22.00 | Adapter PVC 1-1/4" FPT X 1-1/4" Hose |
| 335085 | \$5.36 | Adapter PVC 1-1/4" MPT X 1-1/4" Hose |

PUMPS

Pump Accessories (cont.)

Item Number List Price (USD) Description

PUMP MANIFOLDS - PVC CONSTRUCTION

| | | |
|-----------|----------|--------------------------------------------------------------------|
| 220300007 | \$42.00 | 2 Unit Spud Manifold-"U" Configuration (1/2"FPT x 1/2"HB x 1/2"HB) |
| 220300008 | \$20.00 | 2 Unit Spud Manifold-"T" Configuration (1/2"FPT x 1/2"HB x 1/2"HB) |
| 220300009 | \$23.00 | 2 Unit Spud Manifold-"F" Configuration (1/2"FPT x 1/2"HB x 1/2"HB) |
| 220300003 | \$120.00 | 3 Unit Spud Manifold (3/4"HB w/ (3) 1/2"HB outlets) |
| 220300004 | \$145.00 | 4 Unit Spud Manifold (1"HB w/ (4) 1/2" HB outlets) |
| 220300005 | \$175.00 | 5 Unit Spud Manifold (1"HB w/ (5) 1/2" HB outlets) |
| 220300006 | \$265.00 | 6 Unit Spud Manifold (1"HB w/ (6) 1/2" HB outlets) |

PUMP RELAYS

| | | |
|-----------|----------------|-----------------------------------------------------|
| 224110040 | \$285.00 | Two Unit Solid State Relay, 115V/230V 1phase |
| 224110050 | \$330.00 | Two To Six Unit Solid State Relay, 115V/230V 1phase |
| TBD * | Call For Price | Two To Six Unit Solid State Relay, 230V 3phase * |

* Note: When ordering 3 phase PRP please supply pump size, amp draw, horse power, and/or part number.

SEAWATER HOSE/KITS

| | | |
|-----------|----------|----------------------------------------------------------------------|
| 226000006 | \$4.10 | 5/8" White Reinforced Seawater Hose - sold in 1' lengths (roll=250') |
| 1022312 | \$6.69 | Seawater Hose, 3/4" ID, per Foot |
| 226000049 | \$100.00 | Hose Seawater 5/8" x 25' White |
| 225600010 | \$450.00 | 3/4" Seawater Kit (thru hull, strainer, speed scoop, & ball valve) |
| 225600015 | \$970.00 | 1" Seawater Kit (thru hull, strainer, speed scoop, & ball valve) |
| 225600021 | \$90.00 | 1/2" Seawater Strainer with Bracket |
| 298001188 | \$15.00 | Mounting Bracket for 3/4" Strainer above |

IMPELLERS

| | | |
|---------|------------|-----------------------------------------------|
| 333992 | \$230.00 | P100 Impeller, 2 1/2" Imp |
| 330345 | \$245.00 | P110 Impeller, 2 3/4" Imp |
| 333997 | \$230.00 | P120 Impeller, 3" Imp |
| 334080 | \$90.00 | P300/PMA1000 Impeller, 2 7/8" Imp |
| 334090 | \$110.00 | PML500 Impeller, 2 1/4" Imp (Black old style) |
| 330118 | \$90.00 | PML500 Impeller, 2 3/8" Imp (White new style) |
| 330066 | \$190.00 | PMA1000 Impeller, 2 5/8" Imp (Little Giant) |
| 333995 | \$230.00 | P700 Impeller, 3 1/2" Imp, 1ph |
| 330069 | \$315.00 | P700 Impeller, 3 1/2" Imp, 3ph |
| 330283 | \$320.00 | P700 Impeller, 3" Imp, 3ph |
| 330349 | \$325.00 | P710 Impeller, 3 1/2" Imp, 1ph/3ph |
| 330353 | \$325.00 | P711 Impeller, 4" Imp, 60hz |
| 335155 | \$320.00 | P711 Impeller, 4 1/4" #78 |
| 1039102 | \$320.00 | P711 Impeller, 4 1/2" #78 |
| 332597 | \$320.00 | P711 Impeller, 4 3/4" Imp, 3ph, 50hz |
| 334747 | \$1,130.00 | P715 SW/CW Impeller, 4.5" #17 |
| 334650 | \$1,265.00 | P715 SW/CW Impeller, 4.75" |
| 1014000 | \$1,330.00 | P715 SW/CW Impeller 5.12" |
| 1038099 | \$435.00 | PH3000B3X Impeller, 4" |
| 1038906 | \$280.00 | PH4000B3X Impeller, 4" |
| 055100 | \$115.00 | P1500 Impeller |
| 1031102 | \$160.00 | P3000 Impeller Kit 3" |
| 1031103 | \$160.00 | PH3000 Impeller Kit 3 1/2" |

PUMPS

Pump Accessories (cont.)

Item Number List Price (USD) Description

PUMP HEAD ASSY & PARTS

| | | |
|-----------|----------|-------------------------------------------------------------------------|
| 725115006 | \$245.00 | A-508P, Pump Head Assy. PM/PMP/PML500 |
| 725115004 | \$215.00 | Pump Head Assy. PMA1000 Complete |
| 050800 | \$15.00 | O-Ring PM/PMP/PML/PMA500 Head Cover |
| 052401 | \$15.00 | O-Ring PM/PMP/PML500 Housing |
| 050900 | \$15.00 | O-Ring Headcover PMA1000 Pump |
| 331073 | \$41.00 | Plastic Mount Base for PM/PMP/PML250 & PML500 |
| 334005 | \$245.00 | PML250/P400 Wet End Assy |
| 330123 | \$255.00 | PML500 Wet End Assy (Pump Head, Imp., Gaskets & Seal) |
| 334058 | \$315.00 | P510 Little Giant Wet End Assy |
| 331692 | \$180.00 | PMA500 Wet End Assy (Pump Head, Imp., Gaskets & Seal) |
| 334007 | \$240.00 | PMA1000 March Wet End Assembly (Pump Head, Impeller, Gaskets, and Seal) |
| 1031000 | \$675.00 | P1500 Pump Head Assy |
| 1031101 | \$890.00 | Housing with hardware P3000/PH3000 Pumps |

MOUNT KIT & SEAL/GASKET KIT

| | | |
|-----------|----------|------------------------------------------------------------------------------|
| 725115001 | \$70.00 | Mount Kit for PMA500 & PMA1000 |
| 297000040 | \$115.00 | Mount Kit for P1500/P3000/PH3000BXT |
| 333990 | \$95.00 | Seal Kit #67-68 (P100-P700-PS1500BX- PS2200BX) |
| 333169 | \$240.00 | Seal Kit #16B-17 type 206 - #121 type TCX (P715) |
| 330071 | \$155.00 | Seal Kit #72-78 (P710-P711-PS1500B3X - PH3000B3X, P3600BX - PH4000B3X) |
| 335216 | \$70.00 | Seal Kit for PS700 (Z) & PS715 |
| 332068 | \$320.00 | Seal Kit #17 type 17 - #121 type 121 CW 1.5" |
| 725112000 | \$255.00 | Seal Kit P1200 (beginning serial #449xxxxx, dated 12/5/04) |
| 725115007 | \$100.00 | Seal Kit P1500BX/L old gasket w/seals (w/serial #s before 515xxxxx, 4/15/05) |
| 725115000 | \$140.00 | Seal Kit P1500BX (beginning w/ serial # 515xxxxx, dated 4/15/05) |
| 725115002 | \$95.00 | Seal Kit P3000BXL old style (w/ serial #s before 449xxxxx, dated 12/5/04) |
| 725130000 | \$140.00 | Seal Kit P3000BX & BXL (beginning w/ serial #s 449xxxxx, dated 12/5/04) |
| 1032310 | \$275.00 | Kit Pump Repair P1200B old style w/ seals, gasket & impeller |
| 055000 | \$9.79 | Gasket Head P1500 (use w/ serial #s before #515xxxxx, 4/15/05) |
| 056000 | \$7.62 | Gasket Head P3000 (use w/ serial #s before #449xxxxx, 12/5/04) |

WATER FITTINGS AND MANIFOLDS

| | | |
|-----------|----------|-------------------------------------------|
| 338454 | \$4.20 | Bushing, PVC, 1/2" FPT x 3/4" MPT |
| 220300153 | \$135.00 | M11-2, 1/2" FPT Inlet, 2x 5/8" 90° Outlet |
| 220300147 | \$110.00 | M12-2, 3/4" FPT Inlet, 2x 5/8" Outlets |
| 220300148 | \$175.00 | M12-3, 3/4" FPT Inlet, 3x 5/8" Outlets |
| 220300152 | \$295.00 | M12-4, 3/4" FPT Inlet, 4x 5/8" Outlets |
| 220300155 | \$180.00 | M16-2, 1" FPT Inlet, 2x 5/8" Outlets |
| 220300151 | \$195.00 | M16-3, 1" FPT Inlet, 3x 5/8" Outlets |
| 220300150 | \$245.00 | M16-4, 1" FPT Inlet, 4x 5/8" Outlets |
| 220300149 | \$300.00 | M16-5, 1" FPT Inlet, 5x 5/8" Outlets |
| 220300154 | \$420.00 | M16-6, 1" FPT Inlet, 6x 5/8" Outlets |
| 220300161 | \$465.00 | M16-7, 1" FPT Inlet, 7x 5/8" Outlets |

PUMPS

CRUISAIR AUTHORIZED DISTRIBUTORS & DEALERS ONLY

| Item Number | List Price (USD) | Model | Capacity | Power | Ign. Prot | Inlet | Outlet |
|-------------|------------------|-------------|------------|---------|-----------|------------|----------|
| 225500273 | \$1,400.00 | P1200BXT-SP | 1200 @ 5' | 115/230 | No | 1" FPT | 1" FPT |
| 225500270 | \$1,110.00 | P1500BXT | 1320 @ 5' | 115/230 | No | 3/4" FPT | 1/2" MPT |
| 225500284 | \$1,325.00 | PS1500BX | 1500 @ 7' | 115/230 | No | 1 1/4" FPT | 1" FPT |
| 225500277 | \$1,340.00 | PS1800BX | 1800 @ 15' | 115/230 | No | 1 1/4" FPT | 1" FPT |
| 225500279 | \$1,350.00 | PS2200BX | 2200 @ 15' | 115/230 | No | 1 1/4" FPT | 1" FPT |
| 225500271 | \$1,475.00 | P3000BXT | 3000 @ 7' | 115/230 | No | 1 1/4" FPT | 1" FPT |
| 225500272 | \$1,475.00 | PH3000BXT | 3000 @ 20' | 115/230 | No | 1 1/4" FPT | 1" FPT |
| 225500314 | \$2,030.00 | PS3000B3X | 3000 @ 20' | 230/460 | No | 1 1/4" FPT | 1" FPT |

PUMP RELAYS, TRIGGERS AND PARTS

| Item Number | List Price (USD) | Description |
|-------------|------------------|---------------------------------------------------------------------------|
| 724200022 | \$310.00 | PR3X, Pump Relay, 115/230V, Up to 3 Triggers (not included) |
| 724200017 | \$335.00 | PR3X-2, Pump Relay, 115/230V, with two 115V Triggers |
| 724200015 | \$335.00 | PR3X-2C, Pump Relay, 115/230V, with two 230V Triggers |
| 724200018 | \$360.00 | PR3X-3, Pump Relay, 115/230V, with three 115V Triggers |
| 724200016 | \$360.00 | PR3X-3C, Pump Relay, 115/230V, with three 230V Triggers |
| 724200019 | \$325.00 | PR8X, Pump Relay, 115/230V, Up to 8 Triggers (not included) |
| 724200024 | \$435.00 | PR8X-4, Pump Relay, 115/230V, with four 115V Triggers |
| 724200020 | \$435.00 | PR8X-4C, Pump Relay, 115/230V, with four 230V Triggers |
| 724200021 | \$460.00 | PR8X-5C, Pump Relay, 115/230V, with five 230V Triggers |
| 724200027 | \$490.00 | PR8X-6C, Pump Relay, 115/230V, with six 230V Triggers |
| 724200026 | \$520.00 | PR8X-7C, Pump Relay, 115/230V, with seven 230V Triggers |
| 4134000 | \$180.00 | Relay Solid State 25 AMP 48-280VAC |
| 4134100 | \$180.00 | Relay Solid State 40 AMP 48-280VAC |
| 4134200 | \$255.00 | Relay Solid State 75 AMP 48-280VAC |
| 758000006 | \$42.00 | A-548, Replacement To-3 Triac |
| 701800008 | \$95.00 | A-551, Stud Triac Repl. Assy. |
| 4220048 | \$90.00 | A-552, Relay P.C. Board PR3X, PR8X, PWX |
| TR115 | \$70.00 | Relay Trigger 115V-for PR3X 8X & PWX |
| TR230 | \$70.00 | Relay Trigger 230V- for PR3X 8X & PWX |
| 4130830 | \$245.00 | Contactactor 120V 3 Pole 30A, use on all D & E Models with 115V control |
| 4130630 | \$235.00 | Contactactor 240V 3 Pole 30A, use on all DC & EC Models with 230V control |

Circulating Loop Components

CW Loop Components

| Item | List Price (USD) | Description |
|------|------------------|-------------|
|------|------------------|-------------|

Expansion Tanks

| | | |
|---------|----------|---------------------------------------------|
| 1063515 | \$150.00 | Exp Tank, 2 gal, up to 30-tons, 1/2" MPT |
| 1063530 | \$235.00 | Exp Tank, 4.4 gal, up to 60-tons, 1/2" MPT |
| 1063560 | \$495.00 | Exp Tank, 7.6 gal, up to 100-tons, 1/2" MPT |



Note: Select tank based on total air handler capacity.

Fill Components

| | | |
|-----------|----------|----------------------------------------------------------------|
| 263400101 | \$320.00 | HWRV Fill Assembly, 1/2"FPT, Press. Reducer & Fill Valve |
| 334758 | \$220.00 | Press. Reducing Valve, 12psi, fast-fill, 1/2" FPT |
| 335225 | \$650.00 | Backflow preventer for fill line, 1/2"FPT (Reduced Press Zone) |
| 1070200 | \$210.00 | Back Flow Preventer 1/2" FPT (not for permanent connection) |
| 1070201 | \$395.00 | Pressure Regulator/Relief Valve 1/2" FPT |
| 1070030 | \$70.00 | Pressure Gauge, 0 - 30 PSI, 1/4" MPT |
| 1070031 | \$70.00 | Pressure Gauge, 0 - 60 PSI, 1/4" MPT |



Air/Dirt/Air-and-Dirt Separators

| | | |
|-----------|------------|------------------------------------------------------|
| 334152 | \$210.00 | 1/2" Spirotop (install at high points in CW system) |
| 334132 | \$450.00 | 1-1/4" inline Spirovent, 15gpm (60k BTU/hr)X |
| 334151 | \$630.00 | 1-1/2" inline Spirovent, 30gpm (120k BTU/hr)X |
| 297700297 | \$3,165.00 | DSV2/240 Dual Spirovent, 2" FPT, 60gpm (240k BTU/hr) |

*If interested in these items, please contact your Cruisair Sales/Applications Representative.



Loop Y-Strainers

| | | |
|---------|------------|----------------------------------|
| 1010012 | \$230.00 | "Y" Strainer, Bronze, 1 1/4" FPT |
| 335345 | \$410.00 | "Y" Strainer, Bronze, 1 1/2" FPT |
| 335404 | \$520.00 | "Y" Strainer, Bronze, 2" FPT |
| 335263 | \$845.00 | "Y" Strainer, Bronze, 2 1/2" FPT |
| 335264 | \$1,145.00 | "Y" Strainer, Bronze, 3" FPT |

Balancing Flow Controls (see note)

| | | |
|-----------|----------|------------------------------------|
| 264600006 | \$415.00 | Balancing Flow Control, 1/2" FPT |
| 264600011 | \$470.00 | Balancing Flow Control, 3/4" FPT |
| 264600009 | \$470.00 | Balancing Flow Control, 3/4" FPT |
| 264600007 | \$470.00 | Balancing Flow Control, 3/4" FPT |
| 264600015 | \$600.00 | Balancing Flow Control, 1" FPT |
| 264600014 | \$600.00 | Balancing Flow Control, 1" FPT |
| 264600013 | \$600.00 | Balancing Flow Control, 1" FPT |
| 264600020 | \$650.00 | Balancing Flow Control, 1 1/4" FPT |
| 264600019 | \$650.00 | Balancing Flow Control, 1 1/4" FPT |
| 264600017 | \$650.00 | Balancing Flow Control, 1 1/4" FPT |
| 264600016 | \$650.00 | Balancing Flow Control, 1 1/4" FPT |

Notes:

1. Subtract Chiller capacity (BTU/hr) from total Air Handler capacity to get BFC size (BTU load).
2. If an exact BFC size is not available, select the next smaller size.

Add Ons And Specialty Units

Breathe Easy™ Air Purifier

| Item Number | List Price (USD) | Description |
|-------------|------------------|-------------------------------------------------------------|
| 4210805 | \$135.00 | Breathe Easy™ Prtble Air Purifier, 12-115-230 |
| 229801254 | \$640.00 | Breathe Easy™ UV Tube 4" |
| 229801255 | \$640.00 | Breathe Easy™ UV Tube 5" |
| 229801252 | \$640.00 | Breathe Easy™ UV Tube 6" |
| 229801253 | \$740.00 | Breathe Easy™ UV Tube 7" |
| 229801256 | \$740.00 | Breathe Easy™ UV Tube 8" |
| 229801604 | \$840.00 | Breathe Easy™ UV Tube 10" |
| 4210800 | \$90.00 | Lamp, UV 5" Induct (used in 4, 5 and 6" tubes) |
| 4210827 | \$100.00 | Lamp, UV 8" Induct/AU Air Handlers (used in 7 and 8" tubes) |
| 4210833 | \$110.00 | Ballast, UV Lamp (for AU Air Handlers) |



WhisperFan Controller

| Item Number | List Price (USD) | Description |
|-------------|------------------|----------------------------|
| 4220054 | \$865.00 | WhisperFan Controller 115V |
| 4220053 | \$865.00 | WhisperFan Controller 230V |



Sound Covers (Turbo Units)

| Item Number | List Price (USD) | Description |
|-------------|------------------|---------------------------------|
| 8010106 | \$225.00 | Tall VT/ST/DTU 6-8K |
| 8010110 | \$225.00 | Short, VT/ST/DTU 10-12K |
| 8010112 | \$225.00 | Tall, VT/ST10-12K |
| 8010114 | \$225.00 | Short, VT/ST/DTU 14-16K |
| 8010116 | \$225.00 | Tall, VT/ST14-16K |
| 336019 | \$13.00 | Sound Cover VT/ST Hardware Pack |

| Model | Turbo ST, VT & DTU Units | | | |
|---------|--------------------------|---------|---------|---------|
| | R22 & R417A | | | R410A |
| Gas | | | | |
| Voltage | 115V | 230V | 220V | ALL |
| 6K & 8K | 8010106 | 8010106 | 8010106 | 8010106 |
| 10K | 8010110 | 8010110 | 8010112 | 8010110 |
| 12K | 8010112 | 8010112 | 8010110 | 8010110 |
| 14K | 8010114 | 8010116 | 8010116 | - |
| 16K | 8010114 | 8010116 | 8010114 | 8010114 |

Smart Start™ Devices (Reduce Startup Surge)

| Item Number | List Price (USD) | Description |
|-------------|------------------|----------------------------------------|
| 337975 | \$540.00 | SmartStart™, 115V, 60Hz, 6K-18K |
| 337976 | \$540.00 | SmartStart™, 208-240V/50-60Hz, 12K-30K |
| 337977 | \$540.00 | SmartStart™, 208-240V/50-60Hz, 36K-60K |
| 4220045 | \$14.00 | SmartStart™ Mounting Tray |



Pilot House Defroster

| Item Number | List Price (USD) | Description |
|-------------|------------------|------------------------------------------|
| 215212005 | \$2,900.00 | PHD12HVZ-1.5KW Defroster, 230V, 3" rings |
| 223150010 | \$450.00 | Control PHD/Z-WHT 3Position: DEF/FAN/Off |
| 223150011 | \$450.00 | Control PHD/Z-BLK 3Position: DEF/FAN/Off |



CRUISAIR SYSTEMS ONLY

Auxiliary Duct Heaters (Heat Modules)

| Item Number | List Price (USD) | Description |
|-------------|------------------|-----------------------------------|
| 715230214 | \$790.00 | HMDL1-5, 1KW, 5", 115V |
| 715230125 | \$790.00 | HMDL1.5-6, 1.5KW, 6", 115V |
| 715230123 | \$790.00 | HMDL1.5-7, 1.5KW, 7", 115V |
| 715230213 | \$790.00 | HMDL1C-5, 1KW 5", 230V |
| 715230126 | \$790.00 | HMDL1.5C-6, 1.5kW, 6", 230V |
| 715230212 | \$810.00 | HMDL2-7, 2KW, 7", 115V |
| HMDL2C-7 | \$810.00 | HMDL2C-7, 2KW, 7", 230V |
| 715230730 | \$810.00 | HMDL3C-9, 3KW, 9", 230V |
| 724600007 | \$455.00 | Auxiliary Heat Relay, 75Amp, 230V |



Add Ons And Specialty Units

Pilot House Defroster Sign-off

PROPRIETARY NOTE: THE INFORMATION CONTAINED WITHIN THIS DOCUMENT IS THE PROPERTY OF DOMETIC CORPORATION. ANY ATTEMPT TO COPY OR DISTRIBUTE WITHOUT WRITTEN CONSENT FROM DOMETIC CORPORATION SHALL BE CONSIDERED UNLAWFUL AND CAN BE CONTESTED IN A COURT OF LAW.

| REV | DATE | REVISION DESCRIPTION | DWG | APR |
|-----|---------|-------------------------------------------------|-----|-----|
| A | 4/16/02 | UPDATE PROPRIETARY NOTE, ADD REV BLK, CAD225-02 | DRR | JES |
| B | 1/10/05 | REMOVED MARINE AIR FROM TITLE BLOCK, CAD028-05 | DRR | JES |
| | | | | |
| | | | | |
| | | | | |

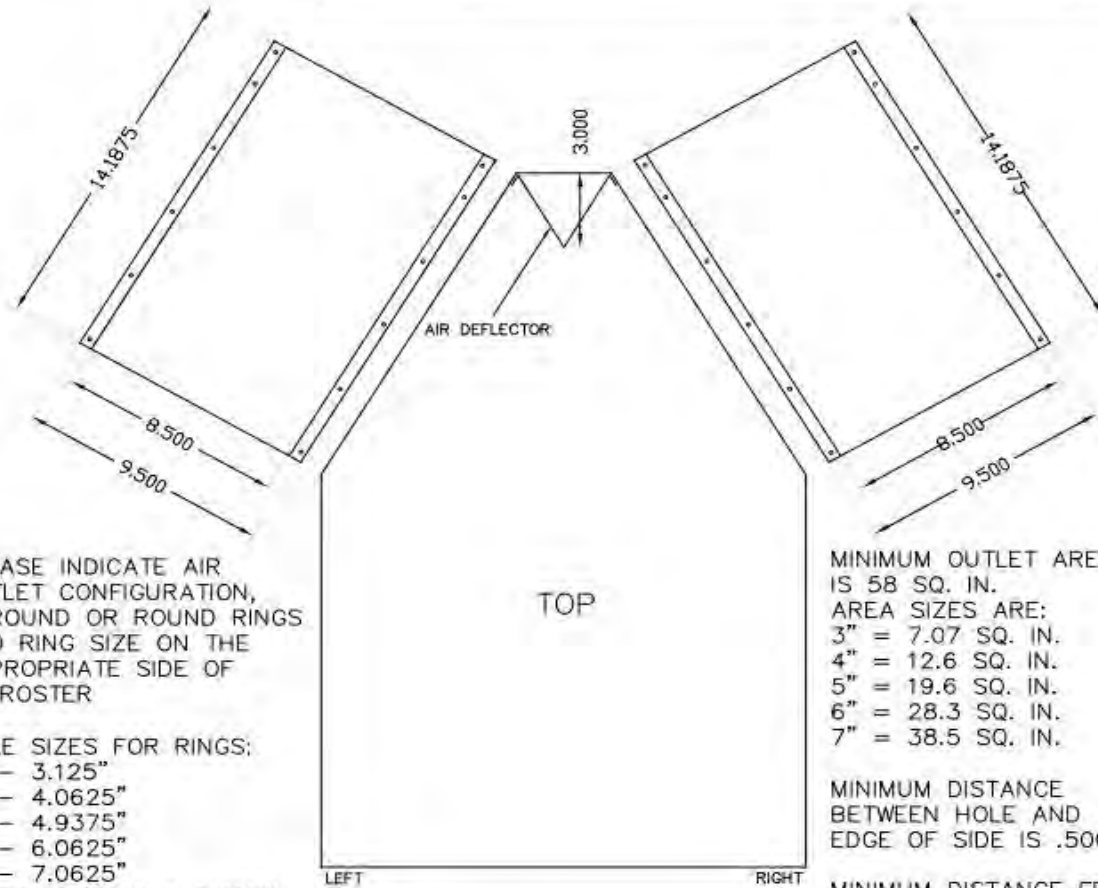

PLEASE INDICATE AIR OUTLET CONFIGURATION, OBOURND OR ROUND RINGS AND RING SIZE ON THE APPROPRIATE SIDE OF DEFROSTER

- HOLE SIZES FOR RINGS:
- 3" - 3.125"
 - 4" - 4.0625"
 - 5" - 4.9375"
 - 6" - 6.0625"
 - 7" - 7.0625"
 - 5" OB - 6.375" X 2.250"
 - 6" OB - 7.250" X 3.250"
 - 7" OB - 9.0625" X 3.250"

MINIMUM OUTLET AREA IS 58 SQ. IN.
 AREA SIZES ARE:
 3" = 7.07 SQ. IN.
 4" = 12.6 SQ. IN.
 5" = 19.6 SQ. IN.
 6" = 28.3 SQ. IN.
 7" = 38.5 SQ. IN.

MINIMUM DISTANCE BETWEEN HOLE AND EDGE OF SIDE IS .500"

MINIMUM DISTANCE FROM HOLE EDGE TO HOLE EDGE IS .250"

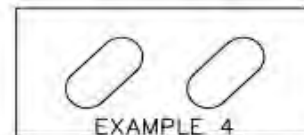
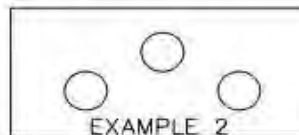
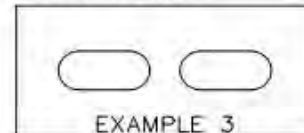
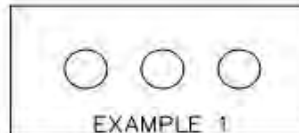

| CUSTOMER SIGN OFF | |
|-------------------|-------|
| DATE: | _____ |
| COMPANY NAME: | _____ |
| YACHT MODEL: | _____ |
| SIGNATURE: | _____ |
| PRINT NAME: | _____ |

| DOMETIC | | PILOT HOUSE DEFROSTER - CUSTOMER SIGN OFF | |
|------------------------------------------|-------------|-------------------------------------------|----------|
| DUCTING RING LOCATIONS AND CONFIGURATION | | | |
| DATE: 7-31-96 | DWG BY: RMW | PART NUMBER: | DWG |
| SCALE: 1/8 | APR BY: D D | N/A | M3020030 |
| | | | REV B |

Add-ons and Specialty Units

Chill Chasers

| Item Number | List Price (USD) | KW | Description |
|--------------------------------------------------------------|------------------|-------|----------------------------------|
| Aux. Heater Assemblies for AT Units | | | |
| 264200021 | \$595.00 | 1KW | CHL CHSR 1KW AT6LH W/CVR |
| 264400510 | \$595.00 | 1KW | CHL CHSR 1KW AT6RH W/CVR |
| 264400506 | \$595.00 | 1KW | CHL CHSR 1KW AT18LH W/CVR |
| 264400517 | \$595.00 | 1KW | CHL CHSR 1KW AT18RH W/CVR |
| 264400520 | \$595.00 | 1KW | CHL CHSR 1KW AT24LH W/CVR |
| 264400521 | \$595.00 | 1KW | CHL CHSR 1KW AT24RH W/CVR |
| 264400508 | \$635.00 | 1.5KW | CHL CHSR 1.5KW AT9/16LH-CVR |
| 264400528 | \$635.00 | 1.5KW | CHL CHSR 1.5KW AT9RH-CVR |
| 264400531 | \$635.00 | 1.5KW | CHL CHSR 1.5KW AT12LH-CVR |
| 264400532 | \$635.00 | 1.5KW | CHL CHSR 1.5KW AT12RH-CVR |
| 264400535 | \$635.00 | 1.5KW | CHL CHSR 1.5KW AT18LH-CVR |
| 264400536 | \$635.00 | 1.5KW | CHL CHSR 1.5KW AT18RH-CVR |
| 264400538 | \$635.00 | 1.5KW | CHL CHSR 1.5KW AT24LH-CVR |
| 264400542 | \$635.00 | 1.5KW | CHL CHSR 1.5KW AT36LH-CVR |
| 264400507 | \$695.00 | 2KW | CHL CHSR 2KW AT12LH W/CVR |
| 264400502 | \$670.00 | 2KW | CHL CHSR 2X1KW AT18LH W/CVR |
| 264400573 | \$670.00 | 2KW | CHL CHSR 2X1KW AT18RH W/CVR |
| 264400546 | \$670.00 | 2KW | CHL CHSR 2X1KW AT24LH W/CVR |
| 264400547 | \$670.00 | 2KW | CHL CHSR 2X1KW AT24RH W/CVR |
| 264400555 | \$755.00 | 3KW | CHL CHSR 2X1.5KW AT18LH-CVR |
| 264400553 | \$755.00 | 3KW | CHL CHSR 2X1.5KW AT18RH-CVR |
| 264400503 | \$755.00 | 3KW | CHL CHSR 2X1.5KW AT24LH-CVR |
| 264400556 | \$755.00 | 3KW | CHL CHSR 2X1.5KW AT24RH-CVR |
| Aux. Heater Assemblies for AU Units | | | |
| 264400569 | \$590.00 | 1KW | CHL CHSR 1KW AU6Z-LH/RH-CVR |
| 264400574 | \$590.00 | 1KW | CHL CHSR 1KW AU9-12Z-LH/RH CVR |
| 264400575 | \$600.00 | 1KW | CHL CHSR 1KW AU18Z-LH/RH CVR |
| 264400576 | \$600.00 | 1KW | CHL CHSR 1KW AU24Z-LH/RH CVR |
| 264400565 | \$600.00 | 1.5KW | CHL CHSR 1.5KW AU9-12Z-LH/RH CVR |
| 264400570 | \$600.00 | 1.5KW | CHL CHSR 1.5KW AU18Z-LH/RH CVR |
| 264400572 | \$600.00 | 1.5KW | CHL CHSR 1.5KW AU24Z-LH/RH CVR |
| 264400568 | \$695.00 | 2KW | CHL CHSR 2KW AU9-12Z-LH-CVR |
| 264400564 | \$670.00 | 3KW | CHL CHSR 2X1.5KW AU18Z-LH/RH CVR |
| 264400563 | \$670.00 | 3KW | CHL CHSR 2X1.5KW AU24Z-LH/RH CVR |
| Aux. Heater Assemblies for AU Units with Breathe Easy | | | |
| 264400611 | \$1,130.00 | 1KW | CHL CHSR BE 1KW AU6Z-LH-CVR |
| 264400610 | \$1,130.00 | 1KW | CHL CHSR BE 1KW AU9-12Z-LH-CVR |
| 264400615 | \$1,130.00 | 1.5KW | CHL CHSR BE 1.5KW AU9-12Z-LH-CVR |
| 264400609 | \$1,170.00 | 1.5KW | CHL CHSR BE 1.5KW AU18Z-LH CVR |
| 264400608 | \$1,170.00 | 1.5KW | CHL CHSR BE 1.5KW AU24Z-CVR |
| 264400616 | \$1,490.00 | 3KW | CHL CHSR BE 2X1.5KW AU18Z-LH CVR |
| 264400614 | \$1,490.00 | 3KW | CHL CHSR BE 2X1.5KW AU24Z CVR |

ACCESSORIES

| AIR FILTERS | | | |
|------------------------------------------------------------------------|-------------------------|-------------------------------------|---------------------|
| Item Number | List Price (USD) | Description | Inches (WxL) |
| Black Mesh Filters for Self-Contained Units | | | |
| 335589 | \$1.20 | FILTER, MESH PLSTC BLK 18"W RL | |
| 235000508 | \$23.00 | FILTER, MESH BLK VC/SF/CMC12-16/1 | 11 x 12.5 |
| 235000511 | \$23.00 | FILTER, MESH BLK VC/SF24 | 16.5 x 16.75 |
| 235000522 | \$23.00 | FILTER, MESH BLK | 9.5 x 11 |
| Micro-Particle Anti-Allergenic Filters for Self-Contained Units | | | |
| 235000600 | \$31.00 | FILTER, MICRO VC-SF-CL-ZF5(/1) | 7.875 x 9 |
| 235000601 | \$31.00 | FILTER, MICRO VC-SF-CMC7(/1) | 9.375 x 10 |
| 235000602 | \$31.00 | FILTER, MICRO SXR7 | 8.125 x 8 |
| 235000603 | \$36.00 | FILTER, MICRO VC-CL-ZF-CMC10/1 | 10.875 x 10 |
| 235000604 | \$36.00 | FILTER, MICRO VC-SF-CMC10 LC-ZF10 | 11.875 x 10 |
| 235000605 | \$36.00 | FILTER, MICRO VC-SF-CL-ZF-CMC12/1 | 10.875 x 12 |
| 235000606 | \$36.00 | FILTER, MICRO VC-SF12-16 CL-ZF-CM | 11.875 x 12 |
| 235000607 | \$80.00 | FILTER, MICRO VC-SF24(/1) | 16.375 x 16 |
| 235000638 | \$38.00 | FILTER, MICRO VT6-8K 10.25HX8.875 | 8.875 x 10.25 |
| 235000639 | \$43.00 | FILTER, MICRO VT10-12K 11.5HX10.8 | 10.875 x 11.50 |
| Replacement Filter for EBDE Units | | | |
| 2030210 | \$19.00 | FILTER AIR EBDE30-72 | 18X18X1 |
| Replacement Filters for AU Air handlers | | | |
| 235000906 | \$32.00 | FILTER, POLY AU6 | 8 x 10 |
| 235000909 | \$42.00 | FILTER, POLY AU9-12 | 10 x 12 |
| 235000918 | \$47.00 | FILTER, POLY AU18 | 13.5 X 12 |
| 235000924 | \$60.00 | FILTER, POLY AU24 | 16 x 14 |
| Replacement Filters for AT Air handlers | | | |
| 235000526 | \$15.00 | FILTER, MESH BLK AT6 | 8.25 x 8 |
| 235000527 | \$15.00 | FILTER, MESH BLK AT9 | 10 x 10 |
| 235000528 | \$15.00 | FILTER, MESH BLK AT12 | 11.875 x 10 |
| 235000529 | \$15.00 | FILTER, MESH BLK AT18 & 18-MU | 13.5 x 13 |
| 235000530 | \$20.00 | FILTER, MESH BLK AT24 & 24-MU | 16 x 15.5 |
| 235000531 | \$30.00 | FILTER, MESH BLK AT36 | 18 x 18 |
| 235000535 | \$16.00 | FILTER, MESH BLK ATL18 | 7.25 x 25 |
| 235000625 | \$29.00 | FILTER, MICRO AT4 | 8 x 8 |
| 235000626 | \$29.00 | FILTER, MICRO AT6 | 8 x 8.25 |
| 235000627 | \$38.00 | FILTER, MICRO AT9 | 10 x 10 |
| 235000628 | \$44.00 | FILTER, MICRO AT12 | 10 x 12 |
| 235000629 | \$75.00 | FILTER, MICRO AT15-18 | 13 x 13.5 |
| 235000630 | \$90.00 | FILTER, MICRO AT24 | 15.5 x 16 |
| 235000631 | \$95.00 | FILTER, MICRO AT36 | 18 x 18 |
| 235000925 | \$47.00 | FILTER, POLY AT15/18 | 13.5 x 13 |
| 235000927 | \$42.00 | FILTER, POLY AT9 | 10 x 10 |
| 235000928 | \$42.00 | FILTER, POLY AT12 | 12 x 10 |
| 235000929 | \$60.00 | FILTER, POLY AT24 | 16 x 15 |
| Replacement Filters for AH Draw thru Air Handlers | | | |
| 235000051 | \$26.00 | FILTER, R/A CLMBS 6DT2 AH6DT2, | 11 x 9 |
| 235000052 | \$30.00 | FILTER, R/A CLMBS 9/12DT2 AH9-12DT2 | 14.5 x 11 |
| 235000065 | \$40.00 | FILTER, R/A CLMBS 18DT2 AH18DT2 | 16 x 14 |
| 235000054 | \$44.00 | FILTER, R/A CLMBS 24DT2 AH24DT2 | 17 x 15.75 |



ACCESSORIES

Grilles



Round Plastic Grilles

| Item Number | List Price (USD) | Description |
|--------------|------------------|---------------------------------------------------------------------|
| 333438 | \$25.00 | Round Plastic grille, 2" Euro Style, Black |
| 333441 | \$25.00 | Round Plastic grille, 2" Euro Style, White |
| 333443 | \$25.00 | Round Plastic grille, 2" Euro Style, Off-White |
| 333437 | \$25.00 | Round Plastic grille, 3" Euro Style (flat w/ridged edge), Black |
| 333442 | \$25.00 | Round Plastic grille, 3" Euro Style (flat w/ridged edge), Off White |
| 333439 | \$25.00 | Round Plastic grille, 3" Euro Style (flat w/ridged edge), White |
| 2071002 | \$25.00 | Round Plastic grille, 3" Global Style (convex & smooth), Black |
| 2071003 | \$25.00 | Round Plastic grille, 3" Global Style (convex & smooth), Off White |
| 2071004 | \$25.00 | Round Plastic grille, 3" Global Style (convex & smooth), White |
| 2060301 | \$17.00 | Reducer to connect 3" hose to a V4 RND |
| 228710001 | \$16.00 | 3" Plastic Adapter (to connect 3" ducting to the 4SA) |
| 339660 | \$15.00 | Round Plastic grille, 4", Tan |
| 333351 | \$15.00 | Round Plastic grille, 4", Tan No Damper |
| 335162 | \$15.00 | Round Plastic grille, 4", Black |
| V4 RND BROWN | \$15.00 | Round Plastic grille, 4", Brown, V4 |
| 339284 | \$15.00 | Round Plastic grille, 4", White |
| 332485 | \$15.00 | Round Plastic grille, 4", White No Damper |
| 369947 | \$15.00 | Round Plastic grille,, 4", Off White 4SA |
| 330571 | \$15.00 | Round Plastic grille, 4", Off White 4SA No Damper |
| 339670 | \$15.00 | Round Plastic grille, 4", Black 4SA |
| 339680 | \$15.00 | Round Plastic grille, 4", Brown 4SA |
| 339690 | \$15.00 | Round Plastic grille, 4", Brown 4SA No Damper |
| 717650003 | \$16.00 | Round Plastic grille, 4", Beige |
| 335078 | \$20.00 | Round Plastic grille, 5", White No Damper |

Plastic Grilles with Plenums

| | | |
|-----------|----------|-----------------------------------------------------------------------------|
| 217316016 | \$75.00 | V5X5 PGA-4TB, Plastic Discharge grille, Moveable Vanes, w/ 4" Ring on Back |
| 217316025 | \$125.00 | V8X4 PGA-4TB, Plastic Discharge grille, Moveable Vanes, w/ 4" Ring on Back |
| 217316031 | \$125.00 | V8X4 PGA-5TB, Plastic Discharge grille, Moveable Vanes, w/ 5" Ring on Back |
| 217316009 | \$130.00 | V10X4 PGA-5TB, Plastic Discharge grille, Moveable Vanes, w/ 5" Ring on Back |
| 217316021 | \$130.00 | V10X5 PGA-5TB, Plastic Discharge grille, Moveable Vanes, w/ 5" Ring on Back |
| 217316041 | \$135.00 | V10X8 PGA-6TB, Plastic Discharge grille, Moveable Vanes, w/ 6" Ring on Back |
| 217316032 | \$135.00 | V10X8 PGA-7TB, Plastic Discharge grille, Moveable Vanes, w/ 7" Ring on Back |
| 217316038 | \$125.00 | V12X4 PGA-5TB, Plastic Discharge grille, Moveable Vanes, w/ 5" Ring on Back |

Plastic Grilles with Mounting Frames

| | | |
|-------------|----------|---------------------------------------------------------------------------|
| 217316057 | \$95.00 | V4X10 PGA-R, Plastic Discharge grille, Moveable Vanes, w/ Frame |
| V6X10 PGA-R | \$100.00 | V6X10 PGA-R, Plastic Discharge grille, Moveable Vanes, w/ Frame |
| 217316002 | \$85.00 | V8X4 PGA-R, Plastic Discharge grille, Moveable Vanes, w/ Frame |
| 217316010 | \$90.00 | V10X4 PGA-R, Plastic Discharge grille, Moveable Vanes, w/ Frame |
| 217316054 | \$110.00 | V8X8 PGA-R, Plastic Discharge grille, Moveable Vanes, w/ Frame |
| 217316015 | \$130.00 | V10X8 PG-RF, Plastic Return-Air grille, Fixed Vanes, w/ Frame and Filter |
| 217316000 | \$125.00 | V10X10 PG-RF, Plastic Return-Air grille, Fixed Vanes, w/ Frame and Filter |
| 217316052 | \$130.00 | V10X14 PG-RF, Plastic Return-Air grille, Fixed Vanes, w/ Frame and Filter |
| 217316020 | \$130.00 | V12X12 PG-RF, Plastic Return-Air grille, Fixed Vanes, w/ Frame and Filter |
| 217316018 | \$140.00 | V14X12 PG-RF, Plastic Return-Air grille, Fixed Vanes, w/ Frame and Filter |

ACCESSORIES

Aluminum Return Air Grilles No Filter

| Item Number | List Price (USD) | Size | Description |
|--------------------|-------------------------|--------------|-----------------------------------------------------------|
| V8X6 RA | \$40.00 | 8X6TRA(AL) | 8" x 6" aluminum return grille, 8" louvers - no filter |
| 2071048 | \$35.00 | 8X8TRA(AL) | 8" x 8" aluminum return grille, 8" louvers - no filter |
| 217000199 | \$41.00 | 8X11TRA(AL) | 8" x 11" aluminum return grille 8" louvers - no filter |
| V10X10 RA | \$50.00 | 10X10TRA(AL) | 10" x 10" aluminum return grille, 10" louvers - no filter |
| V10X12 RA | \$50.00 | 10X12TRA(AL) | 10" x 12" aluminum return grille, 10" louvers - no filter |
| 217000228 | \$30.00 | 10X4TRA(AL) | 10" x 4" aluminum return grille 10" louvers - no filter |
| V10X6 RA | \$40.00 | 10X6TRA(AL) | 10" x 6" aluminum return grille, 10" louvers - no filter |
| 217300152 | \$37.00 | 10X8TRA(AL) | 10" x 8" aluminum return grille, 10" louvers - no filter |
| 217000226 | \$80.00 | 11X12TRA(AL) | 11" x 12" aluminum return grille 11" louvers - no filter |
| 217300012 | \$37.00 | 11X7TRA(AL) | 11" x 7" aluminum return grille 11" louvers - no filter |
| 217000202 | \$40.00 | 11X8TRA(AL) | 11" x 8" aluminum return grille 11" louvers - no filter |
| 335856 | \$55.00 | 12X12TRA(AL) | 12" x 12" aluminum return grille 12" louvers - no filter |
| V12X12 RA | \$55.00 | 12X12TRA(AL) | 12" x 12" aluminum return grille, 12" louvers - no filter |
| V12X6 RA | \$37.00 | 12X6TRA(AL) | 12" x 6" aluminum return grille, 12" louvers - no filter |
| 217000224 | \$39.00 | 14X7TRA(AL) | 14" x 7" aluminum return grille 14" louvers - no filter |
| 217000223 | \$47.00 | 14X10TRA(AL) | 14" x 10" aluminum return grille 14" louvers - no filter |
| V14X10 RA | \$55.00 | 14X10TRA(AL) | 14" x 10" aluminum return grille, 14" louvers - no filter |
| 217000221 | \$50.00 | 14X12TRA(AL) | 14" x 12" aluminum return grille 14" louvers - no filter |
| V14X14 RA | \$55.00 | 14X14TRA(AL) | 14" x 14" aluminum return grille, 14" louvers - no filter |
| 2071049 | \$45.00 | 16X6TRA(AL) | 16" x 6" aluminum return grille, 16" louvers - no filter |
| 217000220 | \$47.00 | 16X9TRA(AL) | 16" x 9" aluminum return grille 16" louvers - no filter |
| 217000225 | \$50.00 | 20X5TRA(AL) | 20" x 5" aluminum return grille 20" louvers - no filter |
| V22X14 RA | \$80.00 | 22X14TRA(AL) | 22" x 14" aluminum return grille, 22" louvers - no filter |
| 217000222 | \$50.00 | 22X7TRA(AL) | 22" x 7" aluminum return grille 22" louvers - no filter |

Aluminum Return Air grilles With Filter

| | | | |
|-------------|----------|---------------|------------------------------------------------------------|
| V8X8 RAFB | \$70.00 | 8X8TRAF(AL) | 8" x 8" aluminum return grille, 8" louvers - filterback |
| 217000238 | \$70.00 | 8X11TRAF(AL) | 8" x 11" aluminum return grille 8" louvers - filterback |
| V10X10 RAFB | \$80.00 | 10X10TRAF(AL) | 10" x 10" aluminum return grille, 10" louvers - filterback |
| 217000239 | \$80.00 | 10X4TRAF(AL) | 10" x 4" aluminum return grille 10" louvers - filterback |
| 217000236 | \$80.00 | 11X12TRAF(AL) | 11" x 12" aluminum return grille 11" louvers - filterback |
| 217000241 | \$80.00 | 11X7TRAF(AL) | 11" x 7" aluminum return grille 11" louvers - filterback |
| 217000232 | \$110.00 | 11X8TRAF(AL) | 11" x 8" aluminum return grille 11" louvers - filterback |
| 217000240 | \$135.00 | 12X12TRAF(AL) | 12" x 12" aluminum return grille 12" louvers - filterback |
| V12X12 RAFB | \$80.00 | 12X12TRAF(AL) | 12" x 12" aluminum return grille, 12" louvers - filterback |
| 217000233 | \$85.00 | 14X10TRAF(AL) | 14" x 10" aluminum return grille 14" louvers - filterback |
| 217000230 | \$85.00 | 14X12TRAF(AL) | 14" x 12" aluminum return grille 14" louvers - filterback |
| 217300241 | \$105.00 | 14X14TRAF(AL) | 14" x 14" aluminum return grille 14" louvers - filterback |
| 217300038 | \$150.00 | 14X20TRAF(AL) | 14" x 20" aluminum return grille 14" louvers - filterback |
| 217000234 | \$70.00 | 14X7TRAF(AL) | 14" x 7" aluminum return grille 14" louvers - filterback |
| 217000229 | \$85.00 | 16X9TRAF(AL) | 16" x 9" aluminum return grille 16" louvers - filterback |
| 217000235 | \$85.00 | 20X5TRAF(AL) | 20" x 5" aluminum return grille 20" louvers - filterback |
| 217000231 | \$90.00 | 22X7TRAF(AL) | 22" x 7" aluminum return grille 22" louvers - filterback |
| 217000237 | \$100.00 | 28X6TRAF(AL) | 28" x 6" aluminum return grille 28" louvers - filterback |

ACCESSORIES

| Aluminum Double Deflection Supply Grilles with Front Blades Vertical | | | |
|-----------------------------------------------------------------------------|-------------------------|-------------|----------------------------------------------------------|
| Item Number | List Price (USD) | Size | Description |
| V5X12 VH | \$50.00 | 5X12 V-H | Aluminum Discharge grille |
| V6X4 VH | \$45.00 | 6X4 VH-H | Aluminum Discharge grille |
| V6X8 VH | \$50.00 | 6X8 VH-H | Aluminum Discharge grille |
| V6X10 VH | \$50.00 | 6X10 V-H | Aluminum Discharge grille |
| V6X12 VH | \$50.00 | 6X12 V-H | Aluminum Discharge grille |
| V7X7 VH | \$50.00 | 7X7 VH-H | Aluminum Discharge grille |
| V8X10 VH | \$45.00 | 8X10 V-H | Aluminum Discharge grille |
| V8X8 VH | \$50.00 | 8X8 VH-H | Aluminum Discharge grille |
| V10X4 VH | \$50.00 | 10X4 V-H | Aluminum Discharge grille |
| V12X4 VH | \$40.00 | 12X4 V-H | Aluminum Discharge grille |
| V12X12 VH | \$65.00 | 12X12 -H | Aluminum Discharge grille |
| V14X5 VH | \$50.00 | 14X5 V-H | Aluminum Discharge grille |
| V20X4 VH | \$65.00 | 20X4 V-H | Aluminum Discharge grille |
| Aluminum Discharge Grilles with Shutoff Damper | | | |
| 217300085 | \$44.00 | 4X4 VML | Aluminum Discharge grille, with Damper |
| V6X10 VML | \$60.00 | 6X10 VML | Aluminum Discharge grille, with Damper |
| V8X4 VML | \$55.00 | 8X4 VML | Aluminum Discharge grille, with Damper |
| V8X6 VML | \$60.00 | 8X6 VML | Aluminum Discharge grille, with Damper |
| V8X8 VML | \$60.00 | 8X8 VML | Aluminum Discharge grille, with Damper |
| V10X4 VML | \$65.00 | 10X4 VML | Aluminum Discharge grille, with Damper |
| V12X4 VML | \$65.00 | 12X4 VML | Aluminum Discharge grille, with Damper |
| Aluminum Supply Air Grills - Horizontal Louvers | | | |
| 217000201 | \$31.00 | 4X4TH(AL) | 4"x4"TH anodized supply grille w/4" horizontal louvers |
| 217000197 | \$35.00 | 7X7TH(AL) | 7"x7"TH anodized supply grille w/7" horizontal louvers |
| 217000200 | \$31.00 | 8X4TH(AL) | 8"x4"TH anodized supply grille w/8" horizontal louvers |
| 217000198 | \$30.00 | 10X4TH(AL) | 10"x4"TH anodized supply grille w/10" horizontal louvers |
| 217000208 | \$35.00 | 10X5TH(AL) | 10"x5"TH anodized supply grille w/10" horizontal louvers |
| Aluminum Supply Air Grills - Vertical Louvers | | | |
| 217000218 | \$30.00 | 10X4TV(AL) | 10"x4"TV anodized supply grille w/4" vertical louvers |
| 217300128 | \$30.00 | 12X3TV(AL) | 12"x3"TV anodized supply grille w/3" vertical louvers |
| 217300129 | \$35.00 | 12X4TV(AL) | 12"x4"TV anodized supply grille w/4" vertical louvers |
| 217300130 | \$35.00 | 12X5TV(AL) | 12"x5"TV anodized supply grille w/5" vertical louvers |
| 217300131 | \$37.00 | 12X6TV(AL) | 12"x6"TV anodized supply grille w/6" vertical louvers |
| 217300132 | \$31.00 | 14X4TV(AL) | 14"x4"TV anodized supply grille w/4" vertical louvers |
| 217300133 | \$40.00 | 14X5TV(AL) | 14"x5"TV anodized supply grille w/5" vertical louvers |
| 217300134 | \$40.00 | 14X6TV(AL) | 14"x6"TV anodized supply grille w/6" vertical louvers |
| 217300135 | \$40.00 | 14X7TV(AL) | 14"x7"TV anodized supply grille w/7" vertical louvers |
| 217300138 | \$37.00 | 16X4TV(AL) | 16"x4"TV anodized supply grille w/4" vertical louvers |
| 217300140 | \$41.00 | 18X3TV(AL) | 18"x3"TV anodized supply grille w/3" vertical louvers |
| 217300141 | \$44.00 | 20X5TV(AL) | 20"x5"TV anodized supply grille w/5" vertical louvers |

ACCESSORIES

| Teak Return Air Wood Grilles (with Filter) | | | |
|---------------------------------------------------------|-------------------------|-------------|--------------------|
| Item Number | List Price (USD) | Size | Description |
| 217400406 | \$150.00 | 4X8RA(TB) | TK/BRZ |
| 217400419 | \$160.00 | 4X12RA(TB) | TK/BRZ |
| 217400079 | \$170.00 | 8X8RA(TB) | TK/BRZ |
| 217400176 | \$170.00 | 8X10RA(TB) | TK/BRZ |
| 217400137 | \$190.00 | 10X10RA(TB) | TK/BRZ |
| 217400323 | \$200.00 | 10X12RA(TB) | TK/BRZ |
| 217400143 | \$160.00 | 10X6RA(TB) | TK/BRZ |
| 217400081 | \$190.00 | 11X8RA(TB) | TK/BRZ |
| 217400326 | \$170.00 | 12X6RA(TB) | TK/BRZ |
| 217400183 | \$210.00 | 12X12RA(TB) | TK/BRZ |
| 217400147 | \$250.00 | 12X14RA(TB) | TK/BRZ |
| 217400122 | \$190.00 | 14X7RA(TB) | TK/BRZ |
| 217400112 | \$200.00 | 14X10RA(TB) | TK/BRZ |
| 217400111 | \$220.00 | 14X12RA(TB) | TK/BRZ |
| 217400680 | \$220.00 | 14X14RA(TB) | TK/BRZ |
| 217400206 | \$190.00 | 16X6RA(TB) | TK/BRZ |
| 217100103 | \$200.00 | 16X8RA(TB) | TK/BRZ |
| 217400101 | \$210.00 | 16X9RA(TB) | TK/BRZ |
| 217400358 | \$355.00 | 22X6RA(TB) | TK/BRZ |
| Teak Supply Air Wood Grilles | | | |
| 217400000 | \$130.00 | 4X4VH(TB) | TK/BRZ |
| 217400001 | \$140.00 | 6X4VH(TB) | TK/BRZ |
| 217400050 | \$150.00 | 7X7VH(TB) | TK/BRZ |
| V8X4 VH-T | \$140.00 | 8X4VH(TB) | TK/BRZ |
| 217400177 | \$160.00 | 8X8VH(TB) | TK/BRZ |
| 217400005 | \$150.00 | 10X4VH(TB) | TK/BRZ |
| 217400078 | \$150.00 | 10X5VH(TB) | TK/BRZ |
| 217400007 | \$150.00 | 12X4VH(TB) | TK/BRZ |
| 217400121 | \$160.00 | 12X5VH(TB) | TK/BRZ |
| 217400123 | \$160.00 | 12X6VH(TB) | TK/BRZ |
| 217400009 | \$150.00 | 14X4VH(TB) | TK/BRZ |
| 217400011 | \$160.00 | 14X5VH(TB) | TK/BRZ |
| 217400013 | \$180.00 | 14X6VH(TB) | TK/BRZ |
| 217400054 | \$160.00 | 16X4VH(TB) | TK/BRZ |
| 217400153 | \$180.00 | 20X4VH(TB) | TK/BRZ |
| Teak Supply Air Wood Grilles with Shutoff Damper | | | |
| 217400085 | \$190.00 | 4X4VML(TB) | TK/BRZ |
| 217400327 | \$200.00 | 4X6VML(TB) | TK/BRZ |
| 217400325 | \$200.00 | 4X8VML(TB) | TK/BRZ |
| 217400043 | \$200.00 | 6X4VML(TB) | TK/BRZ |
| 217400057 | \$200.00 | 8X4VML(TB) | TK/BRZ |
| 217400125 | \$210.00 | 10X4VML(TB) | TK/BRZ |
| 217400333 | \$230.00 | 10X6VML(TB) | TK/BRZ |
| 217400059 | \$210.00 | 12X4VML(TB) | TK/BRZ |

ACCESSORIES

| Flexible Air Duct | | |
|--------------------------------------------------------------------------|-----------------------|-----------------------------------------|
| Item No. | List Price USD | Description |
| Flexible Duct, Insulated (not UV rated for use with Breathe Easy) | | |
| 226600045 | \$4.10 | Insulated Flex Duct, 3", per Foot |
| 226600014 | \$4.10 | Insulated Flex Duct, 4", per Foot |
| 226600016 | \$4.10 | Insulated Flex Duct, 5", per Foot |
| 226600015 | \$4.10 | Insulated Flex Duct, 6", per Foot |
| 226600000 | \$4.10 | Insulated Flex Duct, 7", per Foot |
| 226600046 | \$5.13 | Insulated Flex Duct, 8", per Foot |
| 226600055 | \$6.15 | Insulated Flex Duct, 9", per Foot |
| 226600054 | \$6.27 | Insulated Flex Duct, 10", per Foot |
| 226600048 | \$7.18 | Insulated Flex Duct, 12", per Foot |
| 226600077 | \$75.00 | Insulated Flex Duct, 3", 25 Ft. Length |
| 226600078 | \$75.00 | Insulated Flex Duct, 4", 25 Ft. Length |
| 226600079 | \$85.00 | Insulated Flex Duct, 5", 25 Ft. Length |
| 226600080 | \$90.00 | Insulated Flex Duct, 6", 25 Ft. Length |
| 226600081 | \$95.00 | Insulated Flex Duct, 7", 25 Ft. Length |
| 226600082 | \$95.00 | Insulated Flex Duct, 8", 25 Ft. Length |
| 226600022 | \$115.00 | Insulated Flex Duct, 9", 25 Ft. Length |
| 226600023 | \$135.00 | Insulated Flex Duct, 10", 25 Ft. Length |
| 226600083 | \$170.00 | Insulated Flex Duct, 12", 25 Ft. Length |
| Flexible Duct, Vinyl (Not Insulated) | | |
| 226600008 | \$6.15 | Vinyl Flex Duct, 2", per Foot |
| 226600009 | \$6.15 | Vinyl Flex Duct, 3", per Foot |
| 226600010 | \$6.15 | Vinyl Flex Duct, 4", per Foot |
| 226600011 | \$7.18 | Vinyl Flex Duct, 5", per Foot |
| 226600012 | \$8.20 | Vinyl Flex Duct, 6", per Foot |
| 226600017 | \$9.23 | Vinyl Flex Duct, 7", per Foot |
| 226600013 | \$12.00 | Vinyl Flex Duct, 8", per Foot |
| 226600047 | \$19.00 | Vinyl Flex Duct, 12", per Foot |
| 226600086 | \$115.00 | Vinyl Flex Duct, 2", 25 Ft. Length |
| 226600087 | \$105.00 | Vinyl Flex Duct, 3", 25 Ft. Length |
| 226600088 | \$130.00 | Vinyl Flex Duct, 4", 25 Ft. Length |
| 226600089 | \$140.00 | Vinyl Flex Duct, 5", 25 Ft. Length |
| 226600090 | \$185.00 | Vinyl Flex Duct, 6", 25 Ft. Length |

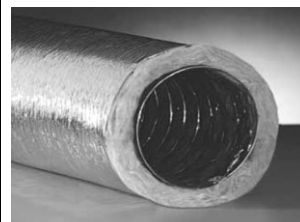

ACCESSORIES

Plastic Grill Transition Boxes with Back Connections (Opposite Grill Opening)

| Item No. | List Price USD | Description |
|-----------|----------------|-----------------------------------------------------------------------|
| VTB44-3B | \$50.00 | Grill Transition Box, Plastic, 4" x 4", with 3" Ring Back |
| VTB44-4B | \$50.00 | Grill Transition Box, Plastic, 4" x 4", with 4" Ring Back |
| 335635 | \$60.00 | VTB64-4B, Grill Transition Box, Plastic, 6" x 4", with 4" Ring Back |
| 229500057 | \$80.00 | VTB84-4B, Grill Transition Box, Plastic, 8" x 4", with 4" Ring Back |
| 229500195 | \$80.00 | VTB84-5B, Grill Transition Box, Plastic, 8" x 4", with 5" Ring Back |
| 229500058 | \$80.00 | VTB104-5B, Grill Transition Box, Plastic, 10" x 4", with 5" Ring Back |
| 229501524 | \$85.00 | VTB106-5B, Grill Transition Box, Plastic, 10" x 6", with 5" Ring Back |
| 229501523 | \$85.00 | VTB106-6B, Grill Transition Box, Plastic, 10" x 6", with 6" Ring Back |

Plastic Grill Transition Boxes with End Connections (On Small Dimension)

| | | |
|-----------|---------|--------------------------------------------------------------------|
| 229500071 | \$60.00 | VTB44-4E, Grill Transition Box, Plastic, 4" x 4", with 4" Ring End |
| 335634 | \$60.00 | VTB64-4E, Grill Transition Box, Plastic, 6" x 4", with 4" Ring End |
| 335195 | \$80.00 | VTB84-4E, Grill Transition Box, Plastic, 8" x 4", with 4" Ring End |
| VTB104-4E | \$85.00 | Grill Transition Box, Plastic, 10" x 4", with 4" Ring End |

Plastic Grill Transition Boxes with Side Connections (On Long Dimension)

| | | |
|-----------|---------|---------------------------------------------------------------------|
| 229500122 | \$80.00 | VTB84-4S, Grill Transition Box, Plastic, 8" x 4", with 4" Ring Side |
| VTB84-5S | \$85.00 | Grill Transition Box, Plastic, 8" x 4", with 5" Ring Side |

Plastic Grill Transition Boxes (Boxes are 5-3/16" Deep)

| | | |
|-----------|---------|--------------------------------------------|
| 229800014 | \$40.00 | Transition Box ABS 4X4 NO CUTS/RINGS |
| 229800044 | \$47.00 | Transition Box ABS 6"X6" NO CUT/RNGS |
| 228700121 | \$47.00 | Transition Box ABS 6X4 NO CUTS/RINGS |
| 229800027 | \$47.00 | Transition Box ABS 7X7 NO CUTS/RINGS |
| 229800017 | \$47.00 | Transition Box ABS 8X4 NO CUTS/RINGS |
| 228700159 | \$47.00 | Transition Box ABS 8X6 NO CUTS/RINGS |
| 229800018 | \$47.00 | Transition Box ABS 10X4 NO CUTS/RINGS |
| 228700118 | \$47.00 | Transition Box ABS 10X4-5"RINGSIDE |
| 229800019 | \$47.00 | Transition Box ABS 12X4 NO CUTS/RINGS |
| 229800022 | \$50.00 | Transition Box ABS 10X5X4.5 NO CUTS/RINGS |
| 229800034 | \$50.00 | Transition Box ABS 10X5X5.75 NO CUTS |
| 228700158 | \$60.00 | Transition Box ABS 10X6 NO CUTS/RINGS |
| 229800023 | \$60.00 | Transition Box ABS 12X5 NO CUTS/RINGS |
| 229800043 | \$80.00 | Transition Box ABS 10"X8" NO CUT/RNG |
| 229800025 | \$65.00 | Transition Box ABS 12X6X4.5 NO CUT/RINGS |
| 229800045 | \$65.00 | Transition Box ABS 12X6X5 NO CUTS/RINGS |
| 229800031 | \$70.00 | Transition Box ABS 12X6X5.75 NO CUTS/RINGS |
| 229800020 | \$50.00 | Transition Box ABS 14X4 NO CUTS/RINGS |
| 229800024 | \$60.00 | Transition Box ABS 14X5 NO CUTS/RINGS |
| 229800026 | \$75.00 | Transition Box ABS 14X6X4.5 NO CUTS/RINGS |
| 229800033 | \$85.00 | Transition Box ABS 14X7X5.5 NO CUTS/RINGS |
| 229800050 | \$85.00 | Transition Box ABS 16"X8" NO CUT/RNG |
| 229800021 | \$65.00 | Transition Box ABS 16X4 NO CUTS/RINGS |
| 229800015 | \$50.00 | Transition Box ABS 4X4 E3 |



ACCESSORIES

Plastic Duct TEEs, Adjustable Baffle

| Item No. | List Price USD | Description | Inlet/Outlet/Outlet |
|-----------|----------------|-------------------------------|---------------------|
| 228700100 | \$115.00 | Transition ABS "T" DUCT 4/4/3 | |
| 228700085 | \$115.00 | Transition ABS "T" DUCT 4/4/4 | |
| 228700093 | \$115.00 | Transition ABS "T" DUCT 5/4/3 | |
| 228700053 | \$115.00 | Transition ABS "T" DUCT 5/4/4 | |
| 228700104 | \$115.00 | Transition ABS "T" DUCT 5/5/3 | |
| 228700062 | \$115.00 | Transition ABS "T" DUCT 5/5/4 | |
| 228700067 | \$115.00 | Transition ABS "T" DUCT 5/5/5 | |
| 228700142 | \$115.00 | Transition ABS "T" DUCT 6/4/4 | |
| 228700108 | \$115.00 | Transition ABS "T" DUCT 6/5/4 | |
| 228700092 | \$115.00 | Transition ABS "T" DUCT 6/5/5 | |
| 228700088 | \$115.00 | Transition ABS "T" DUCT 6/6/3 | |
| 228700114 | \$115.00 | Transition ABS "T" DUCT 6/6/4 | |
| 228700120 | \$115.00 | Transition ABS "T" DUCT 6/6/5 | |
| 228700119 | \$115.00 | Transition ABS "T" DUCT 6/6/6 | |
| 228700106 | \$115.00 | Transition ABS "T" DUCT 7/5/5 | |
| 228700167 | \$115.00 | Transition ABS "T" DUCT 7/6/3 | |
| 228700103 | \$115.00 | Transition ABS "T" DUCT 7/6/4 | |
| 228700115 | \$115.00 | Transition ABS "T" DUCT 7/6/5 | |
| 228700081 | \$115.00 | Transition ABS "T" DUCT 7/6/6 | |
| 228700150 | \$115.00 | Transition ABS "T" DUCT 8/7/7 | |

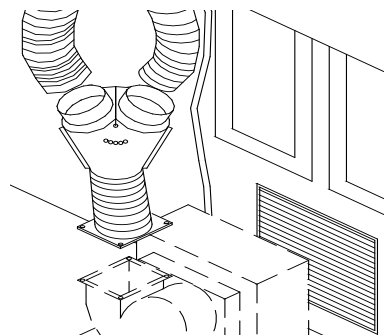

Plastic Duct Ys, Adjustable Baffle

| | | | |
|-----------|----------|-------------------------------|--|
| 228700075 | \$115.00 | Transition ABS "Y" DUCT 3/3/3 | |
| 228700105 | \$115.00 | Transition ABS "Y" DUCT 4/3/3 | |
| 228700078 | \$115.00 | Transition ABS "Y" DUCT 4/4/2 | |
| 228700064 | \$115.00 | Transition ABS "Y" DUCT 4/4/3 | |
| 228700065 | \$115.00 | Transition ABS "Y" DUCT 4/4/4 | |
| 228700134 | \$115.00 | Transition ABS "Y" DUCT 5/4/2 | |
| 228700057 | \$115.00 | Transition ABS "Y" DUCT 5/4/3 | |
| 228700082 | \$115.00 | Transition ABS "Y" DUCT 5/4/4 | |
| 228700069 | \$115.00 | Transition ABS "Y" DUCT 5/5/3 | |
| 228700110 | \$115.00 | Transition ABS "Y" DUCT 5/5/4 | |
| 717050015 | \$115.00 | Transition ABS "Y" DUCT 5/5/5 | |
| 228700073 | \$115.00 | Transition ABS "Y" DUCT 6/4/4 | |
| 228700117 | \$115.00 | Transition ABS "Y" DUCT 6/5/3 | |
| 228700059 | \$115.00 | Transition ABS "Y" DUCT 6/5/4 | |
| 228700074 | \$115.00 | Transition ABS "Y" DUCT 6/5/5 | |
| 228700113 | \$115.00 | Transition ABS "Y" DUCT 6/6/4 | |
| 228700068 | \$115.00 | Transition ABS "Y" DUCT 6/6/5 | |
| 228700101 | \$115.00 | Transition ABS "Y" DUCT 7/5/4 | |
| 228700090 | \$115.00 | Transition ABS "Y" DUCT 7/5/5 | |
| 228700102 | \$115.00 | Transition ABS "Y" DUCT 7/6/4 | |
| VHY765 | \$115.00 | Transition ABS "Y" DUCT 7/6/5 | |
| 228700112 | \$115.00 | Transition ABS "Y" DUCT 7/6/6 | |
| 717050021 | \$115.00 | Transition ABS "Y" DUCT 7/7/3 | |
| VHY774 | \$115.00 | Transition ABS "Y" DUCT 7/7/4 | |
| 228700054 | \$115.00 | Transition ABS "Y" DUCT 8/6/6 | |
| 228700168 | \$115.00 | Transition ABS "Y" DUCT 8/8/8 | |

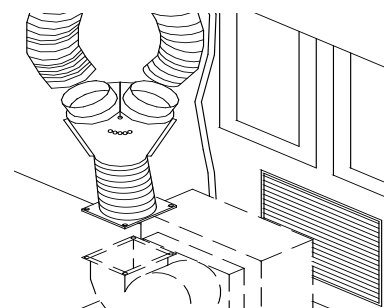

ACCESSORIES

Plastic Blower Ts, Adjustable Baffle

(Mounts over existing Hose adapter)

| Item No. | List Price USD | Description | Inlet/Outlet/Outlet |
|-----------|----------------|-------------------------------|---------------------|
| 228700060 | \$115.00 | Transition ABS "T" BLWR 4/4/4 | |
| 228700076 | \$115.00 | Transition ABS "T" BLWR 5/4/3 | |
| 228700153 | \$115.00 | Transition ABS "T" BLWR 5/4/4 | |
| 228700148 | \$115.00 | Transition ABS "T" BLWR 5/5/3 | |
| 228700154 | \$115.00 | Transition ABS "T" BLWR 6/4/4 | |
| 228700140 | \$115.00 | Transition ABS "T" BLWR 6/5/3 | |
| 228700145 | \$115.00 | Transition ABS "T" BLWR 6/5/4 | |
| 228700083 | \$115.00 | Transition ABS "T" BLWR 6/5/5 | |
| 228700139 | \$115.00 | Transition ABS "T" BLWR 6/6/3 | |
| 228700160 | \$115.00 | Transition ABS "T" BLWR 6/6/6 | |
| 228700066 | \$115.00 | Transition ABS "T" BLWR 7/5/4 | |
| 228700111 | \$115.00 | Transition ABS "T" BLWR 7/5/5 | |
| 228700058 | \$115.00 | Transition ABS "T" BLWR 7/6/4 | |
| 228700091 | \$115.00 | Transition ABS "T" BLWR 7/6/5 | |
| 228700094 | \$115.00 | Transition ABS "T" BLWR 7/6/6 | |
| 228700157 | \$115.00 | Transition ABS "T" BLWR 7/7/4 | |

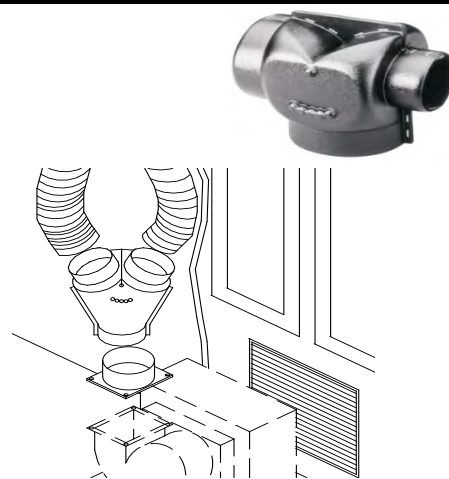

Plastic Blower Ys, Adjustable Baffle

| | | | |
|-----------|----------|-------------------------------|--|
| 228700072 | \$115.00 | Transition ABS "Y" BLWR 4/4/2 | |
| 228700087 | \$115.00 | Transition ABS "Y" BLWR 4/4/3 | |
| 228700086 | \$115.00 | Transition ABS "Y" BLWR 4/4/4 | |
| 228700084 | \$115.00 | Transition ABS "Y" BLWR 5/4/4 | |
| 228700055 | \$115.00 | Transition ABS "Y" BLWR 5/5/3 | |
| 228700063 | \$115.00 | Transition ABS "Y" BLWR 5/5/4 | |
| 228700079 | \$115.00 | Transition ABS "Y" BLWR 6/4/4 | |
| 228700156 | \$115.00 | Transition ABS "Y" BLWR 6/5/4 | |
| 228700109 | \$115.00 | Transition ABS "Y" BLWR 6/5/5 | |
| 228700126 | \$115.00 | Transition ABS "Y" BLWR 6/6/4 | |
| 228700155 | \$115.00 | Transition ABS "Y" BLWR 7/5/5 | |
| 228700096 | \$115.00 | Transition ABS "Y" BLWR 8/6/6 | |

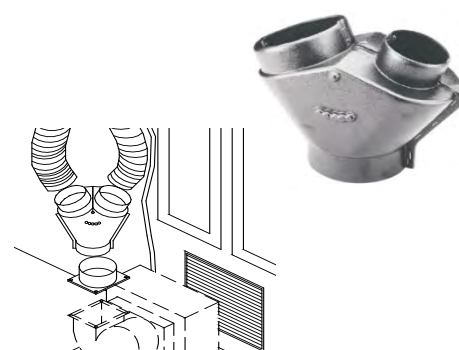

ACCESSORIES

| Aluminum Mount Rings | | |
|-----------------------------|----------------|-----------------------------------------------------------|
| Item Number | List Price USD | Description |
| 228700509 | \$65.00 | Ring ALM 6" Round EBO16 |
| 228701040 | \$90.00 | Ring ALM Duct 6" HC-6 |
| 228701041 | \$90.00 | Ring ALM Duct 7" HC-7 |
| 228700162 | \$100.00 | Ring ALM Duct 9" HC-9 |
| 228701007 | \$135.00 | Ring ALM 9" Round EBOH24 |
| 228701038 | \$135.00 | Ring ALM Duct 9"MR w/Flange 24K HV Blower (2054310) REU24 |
| 228700171 | \$125.00 | Ring ALM Duct 10"MR w/Flange EBE30 |
| 228700180 | \$100.00 | Ring ALM Duct 10"MR w/Base EBO30/36 |
| 228700147 | \$100.00 | Ring ALM 10"OB w/Rectangular Base |

| Plastic Blower Mount Rings | | |
|-----------------------------------|----------------|----------------------------------------|
| Item No. | List Price USD | Description |
| HA-4 | \$17.00 | Ring Plastic 4" Duct EBO4/5 |
| 228701001 | \$27.00 | Mount Ring ABS DCT 4"MR CL5HV/VC5K |
| 291617126 | \$47.00 | Mount Ring ABS DCT ASY 6"MR 16K |
| 335884 | \$18.00 | Blower Mount Ring 5", 4/6K |
| 228700138 | \$100.00 | Ring ABS Trans 5" with TV6 Base |
| 291290011 | \$28.00 | Mount Ring ABS DCT 5" AH6DT2 |
| 228701005 | \$28.00 | Mount Ring ABS DCT 5"MR VC/VR/H6/7 |
| 291600289 | \$28.00 | Mount Ring ABS DCT 5"MR VC5K CUT DWN |
| 291072002 | \$28.00 | Mount Ring ABS DCT 5"MR VC6/7 |
| 335883 | \$20.00 | Blower Mount Ring 6", 6/8K |
| 291617008 | \$47.00 | Mount Ring ABS DCT 6"MR AH12DT2 w/Base |
| 335882 | \$23.00 | Blower Mount Ring 7", 16/18K |
| 228701031 | \$34.00 | Mount Ring ABS DCT 7"MR VR/VC16KHV |
| 228701030 | \$32.00 | Mount Ring ABS DCT 7"MR 24K 6.5X5 |
| 228701033 | \$95.00 | Mount Ring ABS DCT 8"MR VC18HV/AH16D |
| 291150130 | \$100.00 | Mount Ring ABS DCT 8"MR 16HV w/Base |
| 228701027 | \$135.00 | Mount Ring ABS DCT 8"MR 24K w/Base |
| 228701034 | \$42.00 | Mount Ring ABS Trans 8"MR DCU27 |
| 336026 | \$85.00 | Mount Ring ADAPT "L" 3" 90 Degree |
| 336025 | \$85.00 | Mount Ring ADAPT "L" 4" 90 Degree |
| 228700172 | \$85.00 | Trans ABS ELBOW 5" 90 Degree Hose |
| 228700173 | \$85.00 | Trans ABS ELBOW 6" 90 Degree Hose |
| 228700170 | \$85.00 | Trans ABS ELBOW 8" 90 Degree Blower |

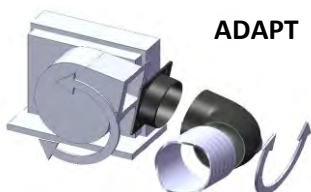
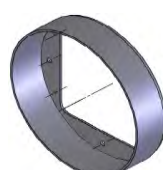

ADAPT

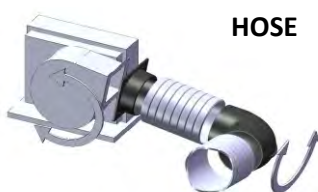

HOSE

ACCESSORIES

Plastic/Aluminum Transition Rings/Hose Adapters

| Item No. | List Price USD | Description | Inlet/Outlet/Outlet |
|-----------|----------------|---------------------------------------------|---------------------|
| 228700008 | \$19.00 | Transition Ring, ABS 1.5" | |
| 228700009 | \$18.00 | Transition Ring, ABS 2" | |
| 228700010 | \$18.00 | Transition Ring, ABS 3" | |
| 228700014 | \$24.00 | Transition Ring, ABS 3" OBLONG | |
| 228700011 | \$18.00 | Transition Ring, ABS 4" 6K | |
| 228700015 | \$20.00 | Transition Ring, ABS 4" OBLONG | |
| 228700127 | \$22.00 | Transition Ring, ABS 4" w/Push Rivets 6K | |
| 228700004 | \$34.00 | Transition Ring, ABS 4" MNTD TO 5"TRNS | |
| 228700012 | \$18.00 | Transition Ring, ABS 5" | |
| 228700016 | \$20.00 | Transition Ring, ABS 5" OBLONG | |
| 228700128 | \$22.00 | Transition Ring, ABS 5" W/PUSH RIVET 8K | |
| 228700132 | \$55.00 | Transition Ring, ABS 5" OB W/PUSH RVTS | |
| 228700013 | \$18.00 | Transition Ring, ABS 6" | |
| 228700017 | \$24.00 | Transition Ring, ABS 6" OBLONG | |
| 228700129 | \$22.00 | Transition Ring, ABS 6" W/PUSH RIVET 10-12K | |
| 228700018 | \$18.00 | Transition Ring, ABS 7" | |
| 228700019 | \$26.00 | Transition Ring, ABS 7" OBLONG | |
| 228700130 | \$24.00 | Transition Ring, ABS 7" W/PUSH RIVET 14-16K | |
| 228700161 | \$105.00 | Transition Ring, ABS 7" RND EBS/EDS W/ALM | |
| 334621 | \$42.00 | Transition Ring, ABS 8" OUTSIDE FLNG | |
| 228700137 | \$49.00 | Transition Ring, ABS 8" W/PUSH RIVET | |



T-Boxes (A.K.A. T-Box Blower Plenums)

First number in model is the unit size (10/12 = 10&12K), second set of numbers are duct size connections.
All transition boxes are ABS plastic. Note: The 7T is 7" high and the 10/12T & 16T are both 8" high.



| Item No. | List Price USD | Model | Description |
|-----------|----------------|---------------|----------------------------|
| 231100515 | \$120.00 | 7T-BX | T-Box VC7/E6 Universal |
| 231100170 | \$120.00 | 7T-BX 5/4 | T-Box VC7/E6 (5/4) |
| 231100510 | \$120.00 | 10/12T-BX | T-Box VC10/12 Universal |
| 231100150 | \$120.00 | 10/12T-BX 5/4 | T-Box VC10/12 (5/4) |
| 231100140 | \$120.00 | 10/12T-BX 5/5 | T-Box VC10/12 (5/5) |
| 231100138 | \$120.00 | 10/12T-BX 6/4 | T-Box VC10/12 (6/4) |
| 231100500 | \$125.00 | 16T-BX | T-Box VC16 Universal |
| 231100130 | \$145.00 | 16T-BX 6/4 | T-Box VC16 (6/4) |
| 229500169 | \$95.00 | 16T-BX 6/6 | Available in Aluminum Only |

*Also available: Custom Alum Box, 50-150 square inch.

* See the **Custom Plenum Request Form** at the back of this section. All prices include two rings.

* If interested in these items, please contact your Marine Air Sales Representative.



ACCESSORIES

CUSTOM PLENUM REQUEST DOMETIC

| | | | |
|------------------------------|------------------------------|-----------------------|-------------------------------------|
| Date: | Requester: | Customer Order No.: | <input type="checkbox"/> Quote Only |
| Customer: | | | NPR# |
| Date NPR Information Needed: | Time NPR Information Needed: | | |
| 1 st Ship Date: | Quantity: | Forecast: Per Month | Per Year |
| NPR Level: A | Target List: S | Replacing / Obsolete: | |

PRODUCT DEFINITION:

SKU:

| | | | | | | | |
|--------------|------------|--------|------------|------------------|--------|--------|--------|
| Item Number: | Lead Time: | days | Prod Code: | Estimated Prime: | \$ | | |
| List Prices: | 21) \$ | 22) \$ | 23) \$ | 24) \$ | 25) \$ | 26) \$ | 27) \$ |

Description:
Extra Description:

Revision A: _____ Date: _____
 Revision B: _____ Date: _____
 Revision C: _____ Date: _____

Specify blower size for blower plenums or dimensions for grille plenums, and ring sizes for each side of box.

BLOWER PLENUM

BLOWER SIZE _____
 E-TOP _____
 D-LEFT _____
 B-RIGHT _____
 C-FACE _____
 A-OPPOSITE _____

- Check if blower is to be rotated.
 Check if HV blower.

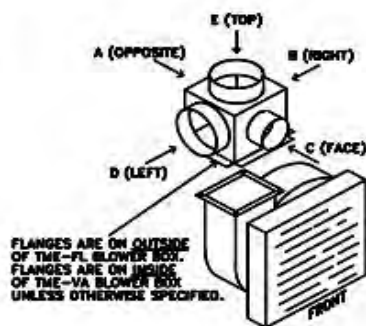

GRILLE PLENUM

WIDTH _____
 HEIGHT _____
 DEPTH _____
 C-TOP _____
 A-BOTTOM _____
 E-OPPOSITE _____
 D-LEFT _____
 B-RIGHT _____

- FLANGE - See notes below.
 To Accommodate Alum Grille - VH VML
 To Accommodate Wood Grille - VH VML

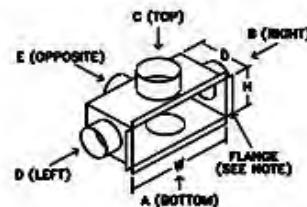

BOX PLENUM

F- INLET/PLATE _____
 E-TOP _____
 D-LEFT _____
 B-RIGHT _____
 C-FACE _____
 A-OPPOSITE _____

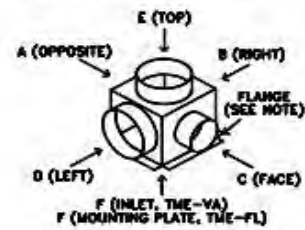

FO-730-007 Revision: H

SKETCH PLENUM HERE (SEE NOTES)

NOTES:

- 1) SHOW DIVERTER PLACEMENT AND DIVISION OF AIR FLOW, RING SIZE AND LOCATION, AND ANY OTHER UNIQUE CHARACTERISTICS.
- 2) STANDARD BOX DEPTH IS 4.50" FOR VACUUM FORMED PLASTIC (TME-FL ONLY). OTHERWISE, BOX DEPTH IS 1/4" DEEPER THAN RING SIZE ON SIDE OF PLENUM.
- 3) FLANGES ARE STANDARD ON TME-FL PLENUMS, BUT OPTIONAL ON TME-VA'S. SPECIFY TME-VA FLANGES BY CIRCILING CHOICE BELOW: WIDTH - HEIGHT - BOTH

THIS VIEW IS LOOKING AT SIDE, FROM OUTSIDE OF BOX (CIRCLE ONE)

THIS VIEW IS LOOKING AT SIDE, FROM OUTSIDE OF BOX (CIRCLE ONE)

Installation Components

Tube Insulation

| Item No. | List Price USD | Description |
|-----------------|-----------------------|-----------------------------------------------------|
| 8010306 | \$5.36 | Insulation Tube, 3/8" ID x 3/8" Wall, 6 Ft. Length |
| 8010408 | \$5.36 | Insulation Tube, 1/2" ID x 3/8" Wall, 6 Ft. Length |
| 336120 | \$5.36 | Insulation Tube, 3/4" ID x 1/2" Wall, 6 Ft. Length |
| 336730 | \$90.00 | Prestite Cork Tape Ins, 2" x 30 Ft. Roll |
| 298001319 | \$255.00 | Insulation Mastic Coating, 1 Gallon with MSDS Sheet |

Condensate Drain Fittings, Plastic

| Item No. | List Price USD | Description |
|-----------------|-----------------------|--------------------------------------------------------------|
| 298001152 | \$29.00 | DF2, Drain Fitting, Straight, 3/8" MPT x 1/2" Hose (10 Pack) |
| 1052608 | \$2.14 | Drain Fitting, Straight, 3/8" MPT x 1/2" Hose |
| 1051410 | \$2.14 | Drain Fitting, Straight, 3/8" MPT x 5/8" Hose |
| 1059510 | \$2.10 | Drain Fitting, Straight, 1/2" MPT x 5/8" Hose |
| 1052708 | \$3.21 | Drain Fitting, 90°, 3/8" MPT x 1/2" Hose |
| 1052410 | \$3.21 | Drain Fitting, 90°, 3/8" MPT x 5/8" Hose |
| 1059610 | \$5.25 | Drain Fitting, 90°, 1/2" MPT x 5/8" Hose |
| 1059708 | \$7.50 | Drain Plug, 1/2" MPT |

Refrigerant Fittings

| Item No. | List Price USD | Description |
|-----------------|-----------------------|---------------------------------------------|
| 3120204 | \$4.28 | Flare Nut, 1/4" |
| 3120106 | \$6.43 | Flare Nut, 3/8" |
| 3121408 | \$6.43 | Flare Nut, 1/2" |
| 3120512 | \$27.00 | Flare Nut, 3/4" |
| 3120606 | \$6.43 | Flare Nut Reducing, 3/8" Flare to 1/4" Tube |
| 3120308 | \$6.43 | Flare Nut Reducing, 1/2" Flare to 3/8" Tube |
| 3120904 | \$7.50 | Flare Tee, 1/4" x 1/4" x 1/4" |
| 3121006 | \$21.00 | Flare Tee, 3/8" x 3/8" x 3/8" |
| 3121808 | \$25.00 | Flare Tee, 1/2" x 1/2" x 1/2" |
| 3130104 | \$34.00 | Flare Tee Reducing, 3/8" x 1/4" x 1/4" |
| 3131006 | \$22.00 | Flare Tee Reducing, 1/2" x 3/8" x 3/8" |
| 3120400 | \$44.00 | Flare Tee Reducing, 3/4" x 1/2" x 1/2" |

DX REPLACEMENT PARTS

Turbo Self Contained Parts Breakdown

PROPRIETARY NOTE: THE INFORMATION CONTAINED HEREIN IS THE PROPERTY OF DOMETIC CORPORATION. ANY ATTEMPT TO COPY OR DISTRIBUTE WITHOUT WRITTEN CONSENT FROM DOMETIC CORPORATION SHALL BE CONSIDERED UNLAWFUL AND CAN BE CONTESTED IN A COURT OF LAW.

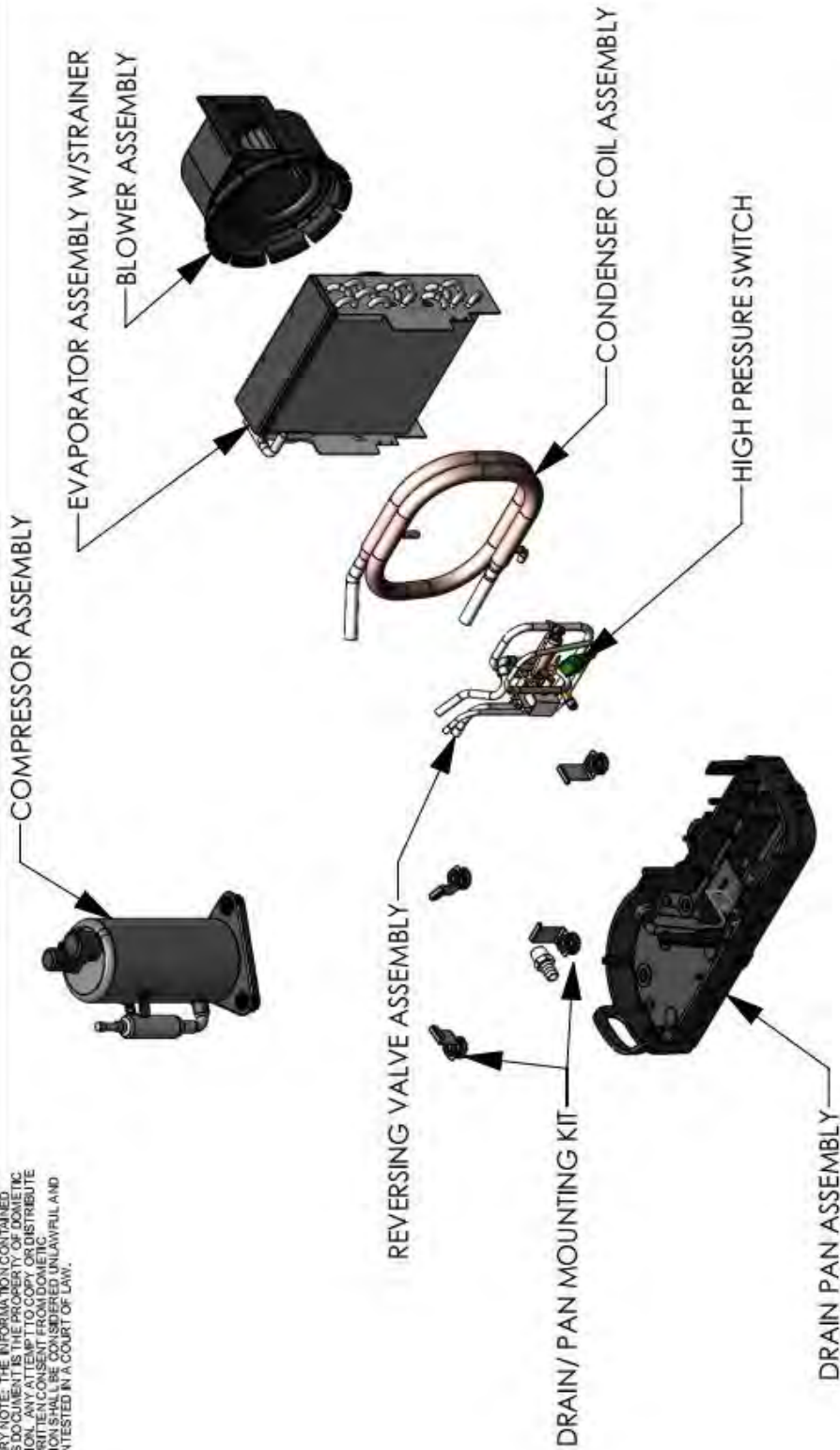

SEE SHEET 2 FOR R410A REPLACEMENT PART NUMBERS
SEE SHEET 3 FOR R417 REPLACEMENT PART NUMBERS

| REV | DATE | REVISION DESCRIPTION | DWG | APR |
|-----|------|----------------------|-----|-----|
| | | | | |
| | | | | |
| | | | | |
| | | | | |
| | | | | |
| | | | | |
| | | | | |
| | | | | |
| | | | | |
| | | | | |

DOMETIC

TURBO REPLACEMENT PARTS - R410A, R417A - 50Hz

| | | | | | | |
|--------|---------|---------|-----|--------------|----------|-----|
| DATE: | 9/15/11 | DWG BY: | DRR | PART NUMBER: | D1020006 | REV |
| SCALE: | | APR BY: | DA | DWG | | |

Turbo Replacement Parts Table

R410A Only

| Turbo unit BTU's, voltage, and frequency | Evap Assembly w/Strainer | Condenser Coil Assembly | Compressor Assembly | Reversing Valve Assembly | Blower Assembly | Comp Overload | Drain Pan Assembly | Dual Run Cap |
|------------------------------------------|--------------------------|-------------------------|---------------------|--------------------------|-----------------|---------------|--------------------|--------------|
| 6K 115V 60Hz | 239401027 | 239401015 | 239402044 | 239100071 | 239400052 | 332849 | 239300022 | 4040028 |
| 8K 115V 60Hz | 239401028 | 239401015 | 239402046 | 239100071 | 239400054 | 332849 | 239300022 | 4040042 |
| 10K 115V 60Hz | 239401029 | 239401016 | 239402049 | 239100073 | 239400056 | 4120047 | 239300023 | 4040029 |
| 12K 115V 60Hz | 239401030 | 239401016 | 239402052 | 239100073 | 239400056 | 4120062 | 239300023 | 4040052 |
| 16K 115V 60Hz | 239401031 | 239401017 | 239402055 | 239100075 | 239400058 | 4120046 | 239300024 | 337047 |
| | | | | | | | | |
| 6K 230V 60Hz | 239401027 | 239401015 | 239402045 | 239100072 | 239400053 | Call for PN | 239300022 | 337048 |
| 8K 230V 60Hz | 239401028 | 239401015 | 239402047 | 239100072 | 239400055 | Call for PN | 239300022 | 4040040 |
| 10K 230V 60Hz | 239401029 | 239401016 | 239402050 | 239100074 | 239400057 | 4120061 | 239300023 | 336033 |
| 12K 230V 60Hz | 239401030 | 239401016 | 239402053 | 239100074 | 239400057 | 4120057 | 239300023 | 4040041 |
| 16K 230V 60Hz | 239401031 | 239401017 | 239402056 | 239100076 | 239400059 | 4120022 | 239300024 | 4040043 |
| | | | | | | | | |
| 6K 220V 50Hz | 239401027 | 239401015 | 239402048 | 239100072 | 239400053 | Call for P/N | 239300022 | 337048 |
| 8K 220V 50Hz | 239401028 | 239401015 | 239402048 | 239100072 | 239400055 | Call for P/N | 239300022 | 4040040 |
| 10K 220V 50Hz | 239401029 | 239401016 | 239402051 | 239100074 | 239400057 | Call for P/N | 239300023 | 336033 |
| 12K 220V 50Hz | 239401030 | 239401016 | 239402054 | 239100074 | 239400057 | Call for P/N | 239300023 | 4040041 |
| 16K 220V 50Hz | 239401031 | 239401017 | 239402057 | 239100076 | 239400059 | 4120040 | 239300024 | 4040044 |
| | | | | | | | | |
| R417A Only | | | | | | | | |
| Turbo unit BTU's, voltage, and frequency | Evap Assembly w/Strainer | Condenser Coil Assembly | Compressor Assembly | Reversing Valve Assembly | Blower Assembly | Comp Overload | Drain Pan Assembly | Dual Run Cap |
| 6K 115V 60Hz | 239401009 | 239401015 | 239402020 | 239100071 | 239400052 | 4043100 | 239300022 | 4040028 |
| 8K 115V 60Hz | 239401010 | 239401015 | N/A | 239100071 | 239400054 | 4120008 | 239300022 | 4040042 |
| 10K 115V 60Hz | 239401011 | 239401016 | 239402025 | 239100073 | 239400056 | 4120038 | 239300023 | 4040029 |
| 12K 115V 60Hz | 239401012 | 239401016 | 239402028 | 239100073 | 239400056 | 4120007 | 239300023 | 4040029 |
| 16K 115V 60Hz | 239401014 | 239401017 | 239402060 | 239100075 | 239400058 | 4120027 | 239300024 | 4040039 |
| | | | | | | | | |
| 8K 230V 60Hz | 239401010 | 239401015 | 239402023 | 239100072 | 239400055 | 4120006 | 239300022 | 4040040 |
| 10K 230V 60Hz | 239401011 | 239401016 | Call for P/N | 239100074 | 239400057 | 4120039 | 239300023 | 336033 |
| 12K 230V 60Hz | 239401012 | 239401016 | 239402029 | 239100074 | 239400057 | 4120010 | 239300023 | 4040037 |
| 16K 230V 60Hz | 239401014 | 239401017 | 239402035 | 239100076 | 239400059 | 4120022 | 239300024 | 4040043 |
| | | | | | | | | |
| 6K 220V 50Hz | 239401009 | 239401015 | 239402021 | 239100072 | 239400053 | 4120024 | 239300022 | 4040034 |
| 8K 220V 50Hz | 239401010 | 239401015 | 239402024 | 239100072 | 239400055 | 4120025 | 239300022 | 4040040 |
| 10K 220V 50Hz | 239401011 | 239401016 | 239402027 | 239100074 | 239400057 | 4120028 | 239300023 | 4040035 |
| 12K 220V 50Hz | 239401012 | 239401016 | 239402030 | 239100074 | 239400057 | 335573 | 239300023 | 4040041 |
| 16K 220V 50Hz | 239401014 | 239401017 | 239402036 | 239100076 | 239400059 | 332859 | 239300024 | 4040044 |

R410A & R417A All sizes and voltages

| Turbo Units 6-16K | Drain Pan Mount Kit | High Pressure Switch - Digital | High Pressure Switch - Mechanical |
|-------------------|---------------------|--------------------------------|-----------------------------------|
| ALL 410A | 7000035 | 4024214 | 4024218 |
| ALL 417A | 7000035 | 4024300 | 4024400 |

R410A & R417A All sizes

| Turbo Units 6-16K | Reversing Valve Solenoid |
|-------------------|--------------------------|
| 410A & 417A 115V | 4071503 |
| 410A & 417A 220V | 4071603 |
| 410A & 417A 230V | 4071603 |

| Turbo Units 6-16K | Circuit Board |
|-------------------|---------------|
| VTD Units | 4220020 |
| STX Units | 722300288 |
| STQ Units | 701800004 |
| DTU Units | 223100502 |

DX REPLACEMENT PARTS

DCU (VCD-SQUF-SXUF)18-27K Parts Breakdown

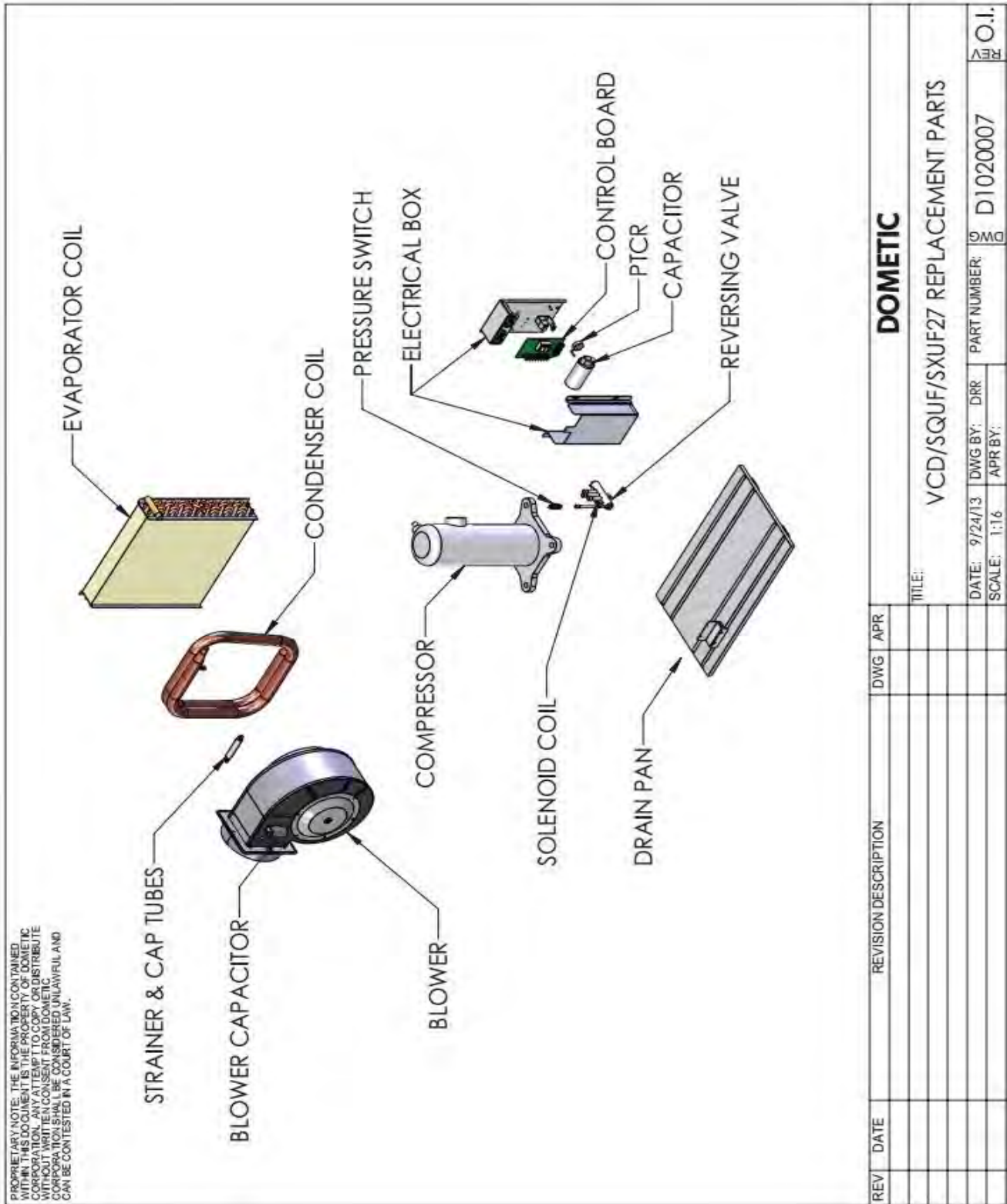

DX REPLACEMENT PARTS

18K - 27K Compact Units Replacement Parts Table

Compact R410A

| Capacity | Voltage | Condenser | Blower | Blower Capacitor | Evap. | Rev. Valve | Solenoid Coil | Mounting Kit | Cap Tube |
|----------|---------|-----------|-----------|------------------|--------|------------|---------------|--------------|----------|
| 18000 | 115V | 293044246 | 239400027 | 331027 | 335898 | 3081409 | 4071502 | 291049008 | 3150018 |
| 18000 | 230V | 293044246 | 239400047 | 2053101 | 335898 | 3081409 | 4071602 | 291049008 | 3150018 |
| 18000 | 220V | 293044246 | 239400047 | 2053101 | 335898 | 3081409 | 4071602 | 291049008 | 3150018 |
| 27000 | 230V | 333344 | 293042221 | 4040058 | 331890 | 3081409 | 4071602 | 291049013 | 332110 |
| 27000 | 220V | 333344 | 293042221 | 4040058 | 331890 | 3081409 | 4071602 | 291049013 | 332110 |

Compact R410A continued

| Capacity | Voltage | Start Cap | Run Cap | PTCR Start Assist | Drain Pan | Strainer | Compressor | Pressure Switch |
|----------|---------|-------------|---------|-------------------|-----------|----------|--------------|-----------------|
| 18000 | 115V | 3100236.235 | 4040160 | 335055 | 239300027 | N/A | Call for P/N | 4024214 |
| 18000 | 230V | 330412 | 4040145 | 335055 | 239300027 | N/A | 239402017 | 4024214 |
| 18000 | 220V | 330412 | 331475 | 335055 | 239300027 | N/A | Call for P/N | 4024214 |
| 27000 | 230V | N/A | N/A | 335055 | 298600001 | 331880 | 298001186 | 4024214 |
| 27000 | 220V | N/A | 330855 | 335055 | 298600001 | 331880 | Call for P/N | 4024214 |

| Compact Units | Circuit Boards |
|---------------|----------------|
| VCD Units | 4220020 |
| SXUF Units | 722300288 |
| SQUF Units | 701800004 |
| DCU Units | 223100502 |

DX REPLACEMENT PARTS

ECD/ECM Replacement Parts Breakdown

PROPRIETARY NOTE: THE INFORMATION CONTAINED
HEREIN IS SOLELY FOR THE USE OF DOMETIC
AND IS NOT TO BE REPRODUCED OR DISTRIBUTED
WITHOUT WRITTEN CONSENT FROM DOMETIC.
COPYRIGHT © 2013. ALL RIGHTS RESERVED.
THIS INFORMATION SHALL BE CONSIDERED UNLAWFUL AND
CAN BE CONTESTED IN A COURT OF LAW.

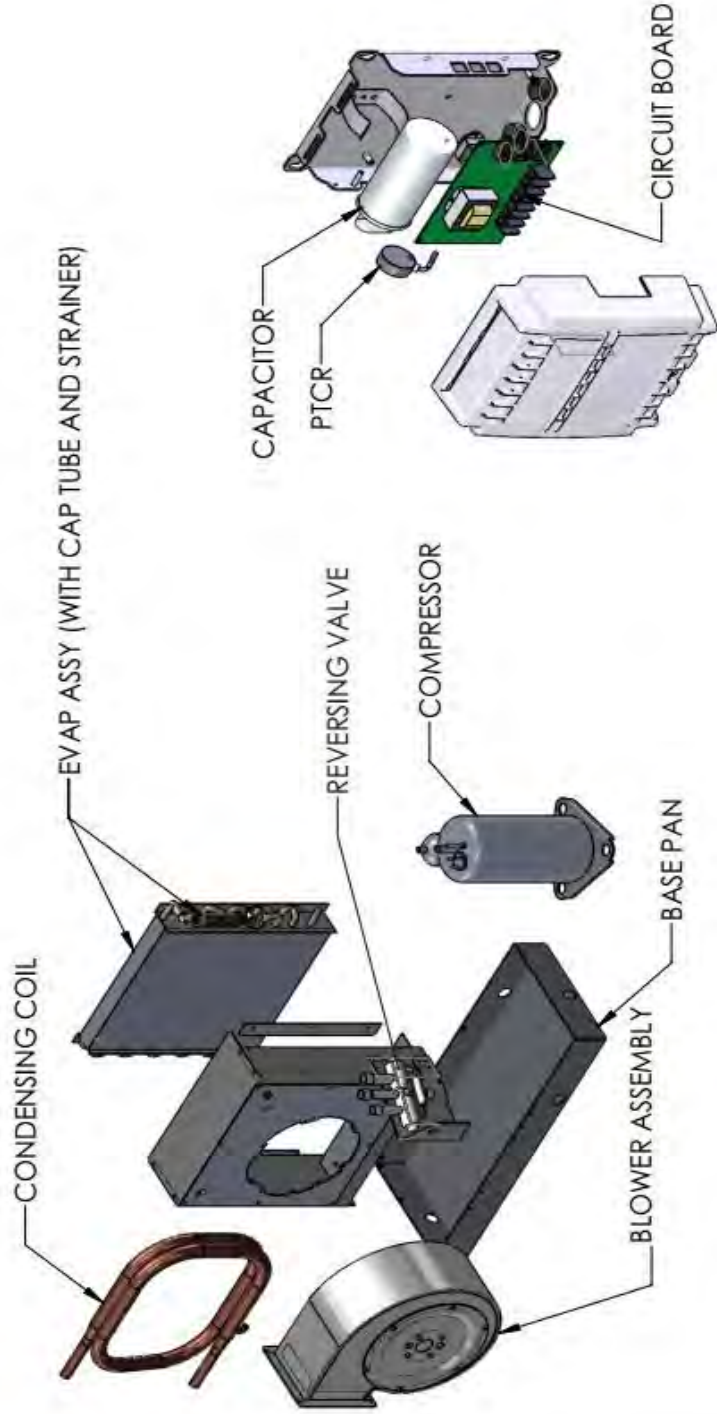

| REV | DATE | REVISION DESCRIPTION | DWG | APR |
|-----|------|----------------------|-----|-----|
| | | | | |
| | | | | |
| | | | | |
| | | | | |
| | | | | |
| | | | | |
| | | | | |
| | | | | |
| | | | | |
| | | | | |

| | | |
|------------------|----------------|-----------------------|
| DOMETIC | | |
| ECD/ECM UNITS | | |
| TITLE: | | |
| DATE: 09/18/2013 | DWG BY: ADOLFO | PART NUMBER: D1020008 |
| SCALE: | APR BY: | DWG |
| | | REV 01 |

ECD/ECM Replacement Parts Table

ECD/ECM 410A

| Capacity | Voltage | Gas | Blower Assy | Blower Capacitor | Compressor Assy | Overload | Reversing Valve Assy | Solenoid Coil | Evap Assy |
|----------|---------|------|----------------|------------------|-----------------|----------|----------------------|---------------|---------------|
| 6K | 115 | 410A | 239400063 | 4040028 | 239402048 | 332849 | 239100078 | 4071503 | 239401019 |
| 10K | 115 | 410A | 239400065 | 4040029 | 239402049 | 4120047 | 239100079 | 4071503 | Call for P/N |
| 16K | 115 | 410A | 239400067 | 4040032 | 239402055 | 4120046 | 239100079 | 4071503 | Call for P/N |
| | | | | | | | | | |
| 6K | 220 | 410A | 239400094 | 337048 | 239402044 | 4120059 | Call for P/N | 4071603 | 239401019 |
| | | | | | | | | | |
| Capacity | Voltage | Gas | Condenser Coil | Hose Adapter | Pressure Switch | PC Board | Display Bezel | Display | Display Cable |
| 6K | 115 | 410A | 332685 | 207500208 | 4024214 | 4220020 | 222000224 | 222000226 | 222103000 |
| 10K | 115 | 410A | Call for P/N | 335883 | 4024214 | 4220020 | 222000224 | 222000226 | 222103000 |
| 16K | 115 | 410A | 335494 | 335883 | 4024214 | 4220020 | 222000224 | 222000226 | 222103000 |
| | | | | | | | | | |
| 6K | 220 | 410A | 332685 | 207500208 | 4024214 | 4220020 | 222000224 | 222000226 | 222103000 |

ECM Models use control P/N 222110102

ECD 417A

| Capacity (BTU/HR) | Voltage | Gas | Blower Assy | Electric Box Assy | Compressor Assy | Evap Assy | Condenser Coil Assy | Drain Pan Assy | Reversing Valve Assy |
|-------------------|---------|------|-------------|-------------------|-----------------|-----------|---------------------|----------------|----------------------|
| 5K | 115 | 417A | 239400063 | 293049285 | 239402020 | 239401019 | 332685 | 239300030 | 239100078 |
| 6.5K | 115 | 417A | 239400064 | 293049286 | N/A | 239401020 | 334555 | 239300031 | 239100078 |
| 9K | 115 | 417A | 239400065 | 293049287 | Call for P/N | 239401021 | 335465 | 239300032 | 239100079 |
| 11K | 115 | 417A | 239400066 | 293049288 | 239402028 | 239401022 | 335465 | 239300032 | 239100079 |
| 15K | 115 | 417A | 239400067 | 293049289 | 239402061 | 239401023 | 335494 | 239300033 | 239100079 |

ECM 417A

| Capacity | Voltage | Gas | Blower Assy | Electric Box Assy | Compressor Assy | Evap Assy | Condenser Coil Assy | Drain Pan Assy |
|----------|---------|------|-------------|-------------------|-----------------|-----------|---------------------|----------------|
| 5K | 115 | 417A | 239400063 | 293049290 | 239402020 | 239401019 | 332685 | 239300030 |
| 6.5K | 115 | 417A | 239400064 | 293049291 | N/A | 239401020 | 334555 | 239300031 |
| 9K | 115 | 417A | 239400065 | 293049292 | Call for P/N | 239401021 | 335465 | 239300032 |
| 11K | 115 | 417A | 239400066 | 293049293 | 239402028 | 239401022 | 335465 | 239300032 |
| 15K | 115 | 417A | 239400067 | 293049294 | 239402061 | 239401023 | 335494 | 239300033 |

DX REPLACEMENT PARTS

Emerald Condenser 6-16K Parts Breakdown

PROPRIETARY NOTE: THE INFORMATION CONTAINED
HEREIN IS UNCLASSIFIED AND IS THE PROPERTY OF DOMETIC
CORPORATION. ANY ATTEMPT TO COPY OR DISTRIBUTE
WITHOUT WRITTEN CONSENT FROM DOMETIC
CORPORATION SHALL BE CONSIDERED UNLAWFUL AND
CAN BE CONTESTED IN A COURT OF LAW.

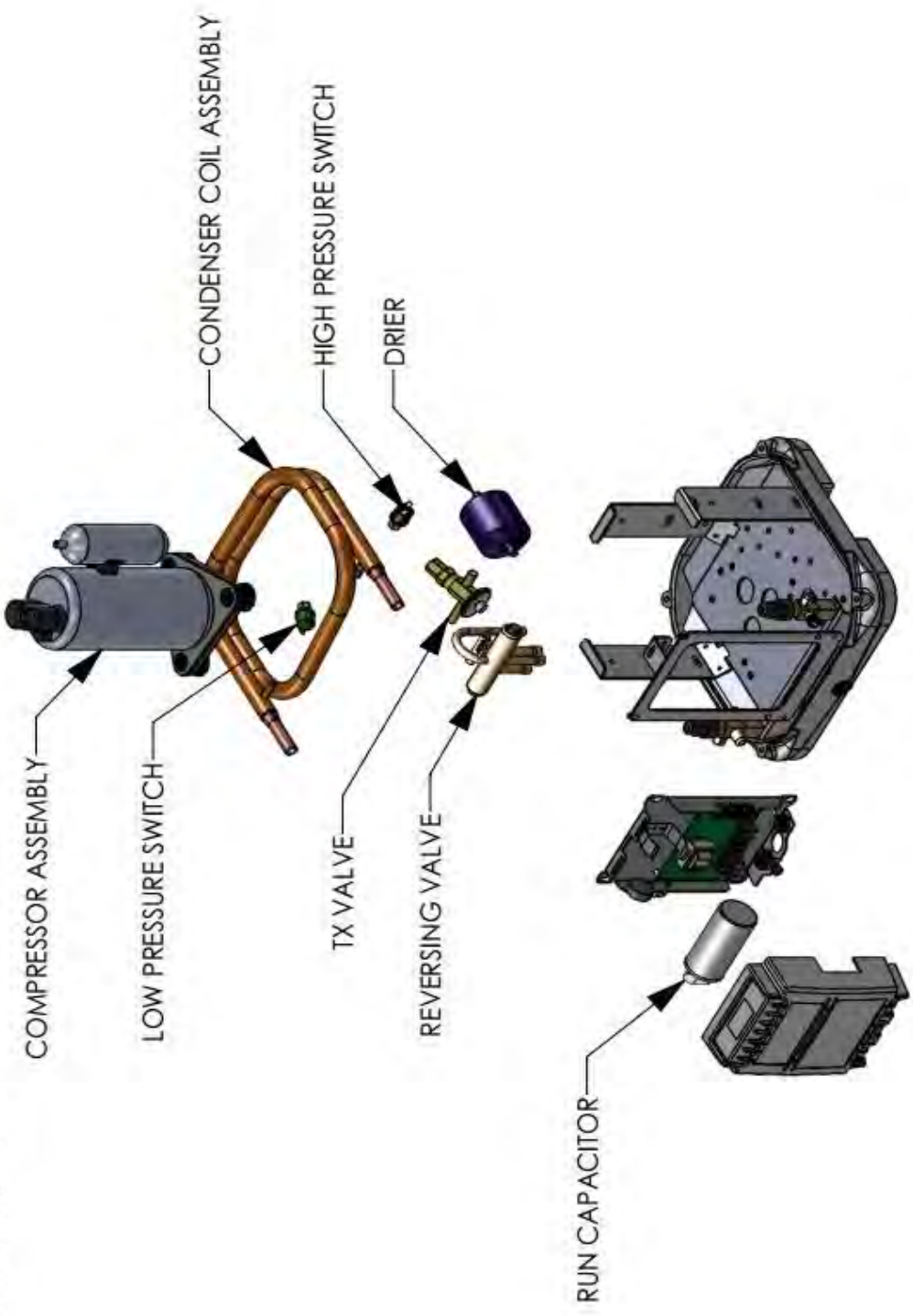

| REV | DATE | REVISION DESCRIPTION | DWG | APR |
|---------------------------------------|------|----------------------|--------------|-------------|
| DOMETIC | | | | |
| EMERALD 6-16 REPLACEMENT PARTS | | | | |
| | | | DATE: 4/9/12 | DWG BY: DRR |
| | | | SCALE: 1:8 | APR BY: DA |
| | | | PART NUMBER: | D2020000 |
| | | | DWG | REV |

Emerald Replacement Parts 6K-16K

| Emerald unit BTU's and voltage | Comp. Assembly | Cond. Coil Assembly | Reversing Valve | Run Cap | Comp Overload | Base Valve Discharge | Base Valve Suction |
|---------------------------------------|-----------------------|----------------------------|------------------------|----------------|----------------------|-----------------------------|---------------------------|
| 6K 115V 60Hz | 293013047 | 239401032 | 3081601 | 331475 | 332849 | 330410 | 337416 |
| 8K 115V 60Hz | 293013048 | 239401032 | 3081601 | 331475 | 332849 | 330410 | 337416 |
| 10K 115V 60Hz | 293013049 | 239401032 | 3081601 | 330855 | 4120047 | 330410 | 337416 |
| 12K 115V 60Hz | 293013050 | 239401033 | 3081409 | 331475 | 4120062 | 330410 | 337416 |
| 16K 115V 60Hz | 293013051 | 239401033 | 3081409 | 4040145 | 4120046 | 330410 | 337417 |
| 6K 200-230V 50/60Hz | 293013052 | 239401032 | 3081601 | 4040115 | 4120059 | 330410 | 337416 |
| 8K 230V 60Hz | 293013053 | 239401032 | 3081601 | 4040115 | 4120059 | 330410 | 337416 |
| 10K 230V 60Hz | 293013054 | 239401032 | 3081601 | 4040115 | 4120061 | 330410 | 337416 |
| 12K 230V 60Hz | 293013055 | 239401033 | 3081409 | 338455 | 4120057 | 330410 | 337416 |
| 16K 230V 60Hz | 293013056 | 239401033 | 3081409 | 4040130 | 4120022 | 330410 | 337417 |
| 8K 220V 50Hz | Call for P/N | Call for P/N | Call for P/N | Call for P/N | Call for P/N | 330410 | 337416 |
| 10K 220V 50Hz | 293013057 | 239401032 | 3081601 | 4040115 | Call for P/N | 330410 | 337416 |
| 12K 220V 50Hz | 293013058 | 239401033 | 3081409 | 333597 | Call for P/N | 330410 | 337416 |
| 16K 220V 50Hz | 293013059 | 239401033 | 3081409 | 333360 | 4120040 | 330410 | 337417 |

| Emerald Units All Sizes & Voltages | Drier | Low Pressure Switch I/O Control | Low Pressure Switch Mechanical Control | High Pressure Switch I/O Control | High Pressure Switch Mechanical Control | TX Valve |
|---------------------------------------------------|--------------|----------------------------------------------------|---------------------------------------------------------------|-----------------------------------------------------|----------------------------------------------------------------|-----------------|
| 6K-16k 115V-220V-230V | 3150409 | 4024219 | 4024217 | 4024214 | 4024218 | 3084704 |

DX REPLACEMENT PARTS

Emerald Condenser Multi-Ton Parts Breakdown

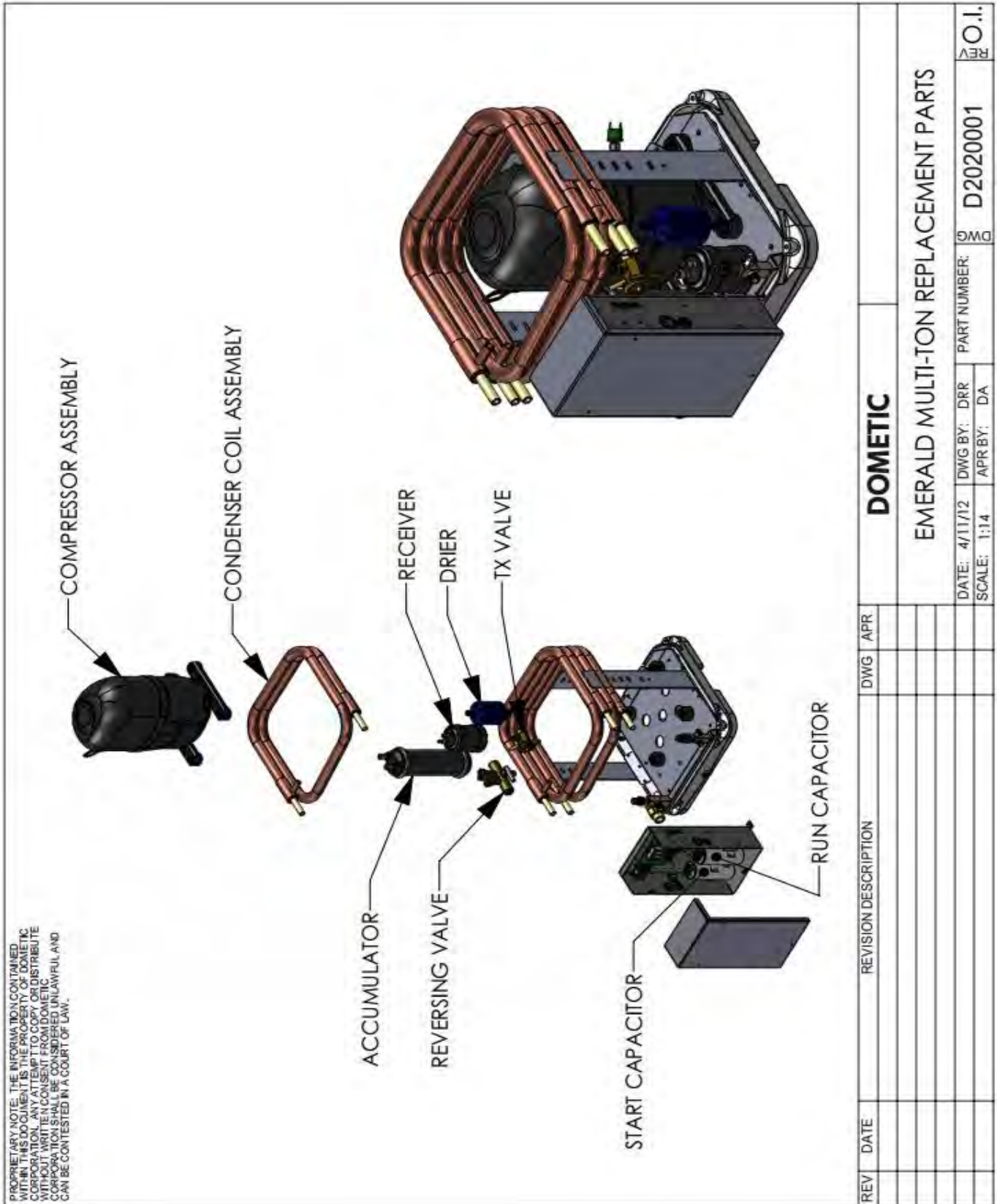

| REV | DATE | REVISION DESCRIPTION | DWG | APR | DOMETIC |
|-----|------|----------------------|-----|-----|-------------------------------------------------|
| | | | | | EMERALD MULTI-TON REPLACEMENT PARTS |
| | | | | | DATE: 4/11/12 DWG BY: DRR PART NUMBER: D2020001 |
| | | | | | SCALE: 1:14 APR BY: DA |
| | | | | | O.I. |
| | | | | | REV |

Emerald Replacement Parts 24K-48K

| Emerald unit BTU's and voltage | Comp. Assembly | Cond. Coil Assembly | Run Capacitor | Start Capacitor | TX Valve | Base Valve Discharge | Base Valve Suction |
|--------------------------------|----------------|---------------------|--------------------------|-----------------|----------|----------------------|--------------------|
| 24K 230V 60Hz | 293600504 | 239401040 | 331475 | 4040076 | 3080058 | 330416 | 298001261 |
| 30K 230V 60Hz | 293600505 | 239401041 | 331475 | 4040076 | 3080058 | 330416 | 337693 |
| 36K 230V 60Hz | 293600506 | 239401042 | 330855 | 335760 | 3080059 | 330416 | 337693 |
| 48K 230V 60Hz | 293600507 | 239401043 | 331520 | 4040106 | 3080059 | 330416 | 337693 |
| 24K 220V 50Hz | 293600508 | 239401040 | 331475 | 4040076 | 3080058 | 330416 | 298001261 |
| 30K 220V 50Hz | 293600509 | 239401041 | 331523 | 332475 | 3080058 | 330416 | 337693 |
| 36K 220V 50Hz | 293600510 | 239401042 | 331520 | 332475 | 3080059 | 330416 | 337693 |
| 48K 220V 50Hz | 293600511 | 239401043 | 335802 | 4040076 | 3080059 | 330416 | 337693 |
| | | | CONTACTOR 3 Phase | | | | |
| 24K 230V 60HZ 3PH | 293600512 | 239401040 | 334398 | | 3080058 | 330416 | 298001261 |
| 30K 230V 60HZ 3PH | 293600513 | 239401041 | N/A | | 3080058 | 330416 | 337693 |
| 36K 230V 60HZ 3PH | 293600514 | 239401042 | 334398 | | 3080059 | 330416 | 337693 |
| 48K 230V 60HZ 3PH | 293600515 | 239401043 | 334398 | | 3080059 | 330416 | 337693 |
| 24K 380V 50HZ 3PH | 293600516 | 239401040 | 334398 | | 3080058 | 330416 | 298001261 |
| 30K 380V 50HZ 3PH | 293600517 | 239401041 | N/A | | 3080058 | 330416 | 337693 |
| 36K 380V 50HZ 3PH | 293600518 | 239401042 | 334398 | | 3080059 | 330416 | 337693 |
| 48K 380V 50HZ 3PH | 293600519 | 239401043 | 334398 | | 3080059 | 330416 | 337693 |
| 24K 460V 60HZ 3PH | 293600522 | 239401040 | 334398 | | 3080058 | 330416 | 298001261 |
| 30K 460V 60HZ 3PH | 293600523 | 239401041 | N/A | | 3080058 | 330416 | 337693 |
| 36K 460V 60HZ 3PH | 293600524 | 239401042 | 334398 | | 3080059 | 330416 | 337693 |
| 48K 460V 60HZ 3PH | 293600525 | 239401043 | 334398 | | 3080059 | 330416 | 337693 |

| Emerald unit BTU's and voltage | Drier | Reversing Valve | Receiver | Accumulator |
|--------------------------------|---------|-----------------|----------|-------------|
| 24K - 36K All Voltages | 3150407 | 3081511 | 331170 | 333150 |
| 48K All Voltages | 3150407 | 3081520 | 3150401 | 3160401 |

| Emerald Units | Circuit Board |
|---------------|---------------|
| ED Units | 4220020 |
| EQ Units | 701800004 |
| DEU Units | 223100502 |

DX REPLACEMENT PARTS

TurboVap Parts Breakdown

PROPRIETARY NOTE: THE INFORMATION CONTAINED
 WITHIN THIS DOCUMENT IS THE PROPERTY OF DOMETIC
 CORPORATION. ANY REPRODUCTION OR DISTRIBUTION
 WITHOUT WRITTEN CONSENT FROM DOMETIC
 CORPORATION SHALL BE CONSIDERED UNLAWFUL AND
 CAN BE CONTESTED IN A COURT OF LAW.

| DRAIN PAN W/ISOLATOR PADS | |
|------------------------------|-----------|
| 4-8K | 239300038 |
| 10-12K | 239300039 |
| 14-16K | 239300040 |

| BLOWER ASSY | |
|-----------------|-----------|
| 6K 115V | 239400052 |
| 8K 115V | 239400054 |
| 10-12K 115V | 239400056 |
| 14-16K 115V | 239400058 |
| 4/6K 220-230V | 239400053 |
| 8K 220-230V | 239400055 |
| 10-12K 220-230V | 239400057 |
| 14-16K 220-230V | 239400059 |

| CAPACITOR | |
|-------------|---------|
| 6K 115V | 2053101 |
| 8K 115V | 330750 |
| 10-12K 115V | 330669 |
| 14-16K 115V | 330750 |
| 6K 230V | 331103 |
| 8K 230V | 2052501 |
| 10-12K 230V | 330670 |
| 14-16K 230V | 4040045 |

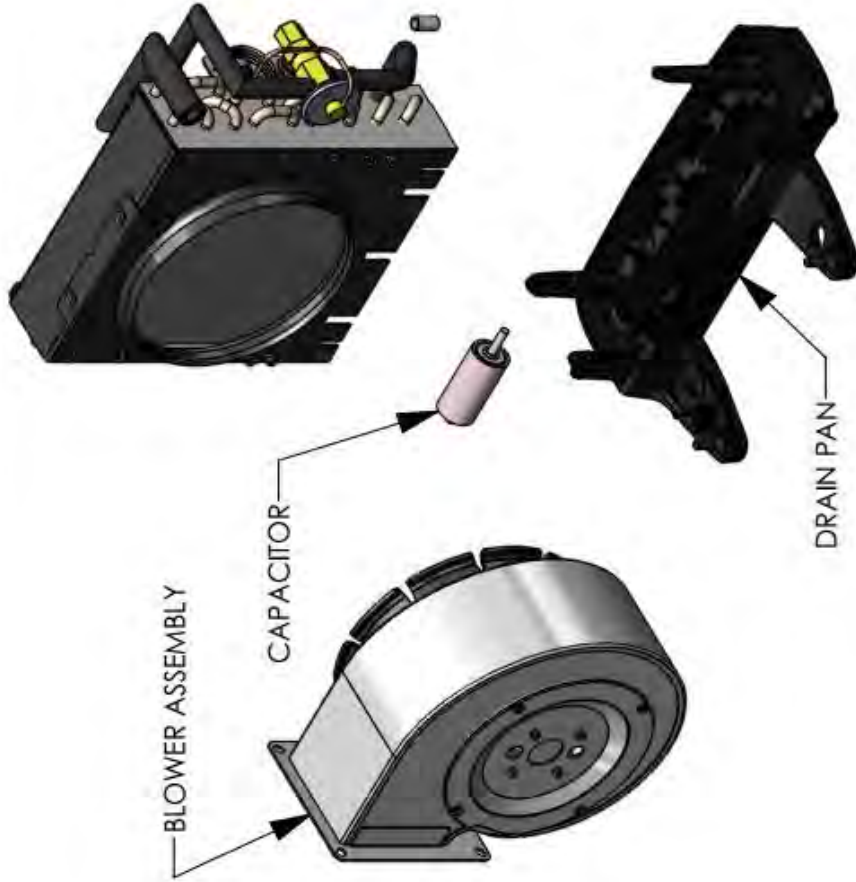

| REV | DATE | REVISION DESCRIPTION | DWG | APR |
|-----|------|----------------------|-----|-----|
| | | | | |
| | | | | |
| | | | | |
| | | | | |

DOMETIC

TV AND TVE REPLACEMENT PARTS

| | | | |
|---------------|-------------|-----------------------|------|
| DATE: 4/11/12 | DWG BY: DRR | PART NUMBER: D2020002 | REV |
| SCALE: 1:5 | APR BY: DA | | O.I. |

TurboVap (TV/TVE) Evaporator Replacement Parts Table

| TurboVap Unit BTU's and Voltage | Drain Pan w/Isolator Pads | List Price (USD) | Blower Assembly | List Price (USD) | Capacitor | List Price (USD) |
|--------------------------------------------|--------------------------------------|-----------------------------|----------------------------|-----------------------------|------------------|-----------------------------|
| 4K 115V | 239300038 | \$70.00 | 239400052 | \$235.00 | 2053101 | \$21.00 |
| 6K 115V | 239300038 | \$70.00 | 239400052 | \$235.00 | 2053101 | \$21.00 |
| 8K 115V | 239300038 | \$70.00 | 239400054 | \$265.00 | 330750 | \$21.00 |
| 10-12K 115V | 239300039 | \$70.00 | 239400056 | \$315.00 | 330669 | \$23.00 |
| 14-16K 115V | 239300040 | \$70.00 | 239400058 | \$360.00 | 330750 | \$21.00 |
| 4K 230V | 239300038 | \$70.00 | 239400053 | \$235.00 | 331103 | \$18.00 |
| 6K 230V | 239300038 | \$70.00 | 239400053 | \$235.00 | 331103 | \$18.00 |
| 8K 230V | 239300038 | \$70.00 | 239400055 | \$265.00 | 2052501 | \$22.00 |
| 10-12K 230V | 239300039 | \$70.00 | 239400057 | \$315.00 | 330670 | \$21.00 |
| 14-16K 230V | 239300040 | \$70.00 | 239400059 | \$360.00 | 4040045 | \$21.00 |

DX REPLACEMENT PARTS

EBE/EBHE Parts Breakdown

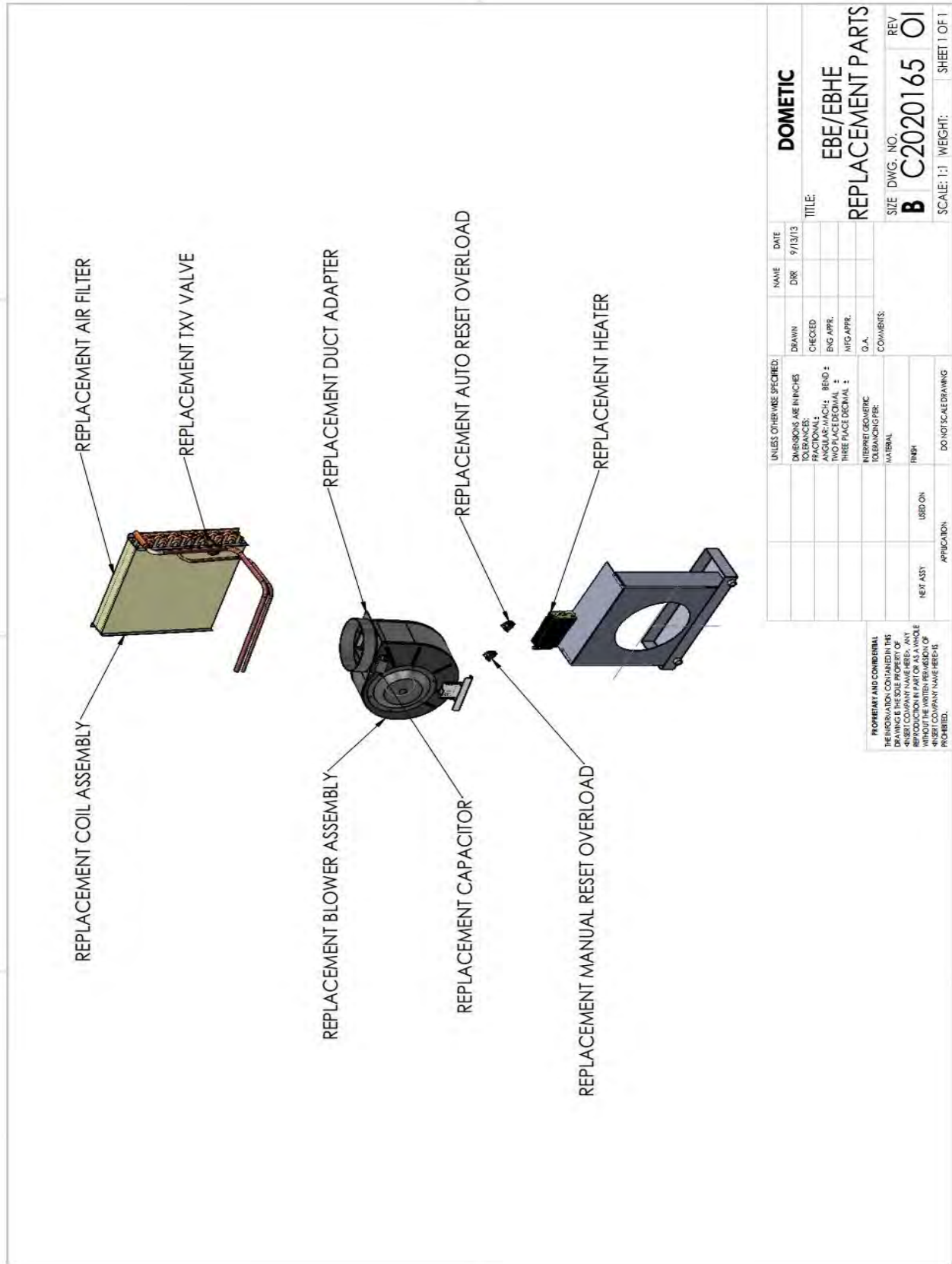

| | | | |
|--------------------------------------|--|-----------|---------|
| UNLESS OTHERWISE SPECIFIED: | | NAME | DATE |
| DIMENSIONS ARE IN INCHES | | DIR | 9/13/13 |
| TOLERANCES: | | DRAWN | |
| FRACTIONAL: | | CHECKED | |
| ANGULAR: MACH: | | ENG APPR. | |
| TWO PLACE DECIMAL: | | MFG APPR. | |
| THREE PLACE DECIMAL: | | G.A. | |
| INTERPRET GEOMETRIC TOLERANCING PER: | | COMMENTS: | |
| MATERIAL: | | | |
| FINISH: | | | |
| NEXT ASSY | | USED ON | |
| APPLICATION: | | | |
| DO NOT SCALE DRAWING | | | |

PROPERTY AND CONFIDENTIALITY NOTICE: THE INFORMATION CONTAINED IN THIS DRAWING IS THE SOLE PROPERTY OF DOMETIC. IT IS TO BE USED FOR THE MANUFACTURE OF THE PARTS SPECIFIED HEREIN ONLY. REPRODUCTION OR TRANSMISSION OF THIS DRAWING OR ANY PART THEREOF WITHOUT THE WRITTEN PERMISSION OF DOMETIC COMPANY IS PROHIBITED.

| | |
|-------------------------------|----------------------|
| DOMETIC | |
| EBE/EBHE REPLACEMENT PARTS | |
| SIZE DWG. NO. | REV |
| B C2020165 | O1 |
| SCALE: 1:1 | WEIGHT: SHEET 1 OF 1 |

EBE/EBHE Replacement Parts Table

| EBE Capacity | Voltage | Coil Assembly | Blower Assembly | Heater | Capacitor | TXV | Duct Adapter | Auto Reset Overload | Manual Reset Overload |
|---------------------|---------------------|----------------------|------------------------|---------------|---------------------|---------------------|---------------------|----------------------------|------------------------------|
| EBE EBHE | EBE EBHE | EBE EBHE | EBE EBHE | EBHE | EBE EBHE | EBE EBHE | EBE EBHE | EBHE | EBHE |
| 6000 | 230V | Call for P/N | Call for P/N | 4200700 | 331103 | 3084704 | 228700138 | 330924 | 4062800 |
| 8000 | 230V | 239401036 | Call for P/N | 4200700 | 2052501 | 3084704 | 335884 | 330924 | 4062800 |
| 10000 | 230V | 239401037 | Call for P/N | 4200800 | 330670 | 3084704 | 335883 | 330924 | 4062800 |
| 12000 | 230V | Call for P/N | Call for P/N | 4200900 | 330670 | 3084704 | 335883 | 330924 | 4062800 |
| 16000 | 230V | Call for P/N | Call for P/N | 4200901 | 4040045 | 3084704 | 335882 | 330924 | 4062800 |
| 18000 | 230V | Call for P/N | 715212424 | n/a | 2053101 | 3080058 | n/a | n/a | n/a |
| 24000 | 230V | Call for P/N | 715212423 | 4200801 (X2) | 4040058 | 3080058 | n/a | 330924 | 4062800 |
| 30000 | 230V | Call for P/N | 239400092 | 4200801 (X2) | 4040058 | 3080058 | 291604194 | 330924 | 4062800 |
| 36000 | 230V | Call for P/N | Call for P/N | n/a | n/a | 3080059 | 291604194 | n/a | n/a |

Note: 24/30K units use (2) 4200801 heaters

EBDE Replacement Parts Table

| EBDE Capacity | Voltage | Air Filter | Blower Motor | EBDE Capacitor | TXV | Blower Housing Wheel |
|----------------------|----------------|-------------------|---------------------|-----------------------|------------|-----------------------------|
| 30000 | 230V | 2030210 | 2054310 | 4040058 | 3080058 | N/A |
| 36000 | 230V | 2030210 | 4032415 | 4041005 | 3080059 | 2053405 |
| 48000 | 230V | 2030210 (2x) | 4032415 | 4041005 | 3080059 | 2053410 |
| 72000 | 230V | 2030210 (2x) | 4032423 | 4040115 | 3080060 | 2053430 |
| 36000 | 220V | 2030210 | 4032422 | 4041007 | 3080059 | 2053405 |
| 48000 | 220V | 2030210 (2x) | 4032422 | 4041007 | 3080059 | 2053410 |
| 60000 | 220V | 2030210 (2x) | 4032421 | 4041007 | 3080060 | 2053430 |
| 72000 | 220V | 2030210 (2x) | 4032421 | 4041007 | 3080060 | 2053430 |

Flex Duct Evaporator Parts Table

| Evaporator Capacity | Voltage | Blower without Mount Ring | Blower with Mount Ring | Coil Assembly for Evaps built thru 2002-03 | Coil Assembly for Evaps built starting 2003 | Strainer with Cap |
|----------------------------|----------------|----------------------------------|----------------------------------|---------------------------------------------------|----------------------------------------------------|--------------------------|
| E4FD | 115V | 293042219 | N/A | 332062 | 332062 | 335466 |
| E6FD | 115V | 293042210 | 239400017 | 333278 | 333278 | 332343 |
| E9FD | 115V | 293042213 | 239400039 5"MR 239400040 6"MR | 333279 | 335510 | 332342 |
| E12FD | 115V | 293042218 | N/A | 333281 | N/A | 332341 |
| E12FD/1 | 115V | 293042215 | N/A | N/A | N/A | 332341 |
| E16FD | 115V | 291617060 | 239400019 | N/A | N/A | 332200 |
| | | | | | | |
| E4FDZ | 230V | 293042211 | N/A | 332062 | 332062 | 335466 |
| E6FDZ | 230V | 293042212 | N/A | 333278 | 333278 | 332343 |
| E9FDZ | 230V | 293042214 | N/A | 333279 | 335510 | 332342 |
| E12FDZ | 230V | 293042216 | N/A | 333281 | N/A | 332341 |
| E12FDZ/1 | 230V | 293042217 | 239400045 | N/A | N/A | 332341 |
| E16FDZ | 230V | 291617061 | 239400042 | 330028 | 330028 | 332200 |

CSD/CSM Replacement Parts Table

| CSD/CSM Capacity | Voltage | Compressor | Cond. Coil | Start Cap | Run Cap | Relay | Base Valves | Drain Pan Assembly |
|-------------------------|----------------|-------------------|-------------------|------------------|----------------|--------------|------------------------------|---------------------------|
| 6000 | 115V | 293013032 | 369627 | 330412 | 4040115 | 4040060 | 330410 (1/4) 330416 (3/8) | 291603723 |
| 9000 | 115V | 293013034 | 369627 | 330412 | 331475 | 4040060 | 330410 (1/4) 330416 (3/8) | 291603723 |
| 12000 | 115V | 293013036 | 331235 | 4040543 | 333360 | 4040060 | 330410 (1/4) 330416 (3/8) | 291603723 |
| 16000 | 115V | 293013038 | 331235 | 330559 | 331475 | 4040060 | 330410 (1/4) 330417 (1/2) | 291603723 |
| | | | | | | | | |
| 6000 | 220V | 293013032 | 369627 | 330412 | 4040115 | 4040060 | 330410 (1/4) 330416 (3/8) | 291603723 |
| 9000 | 220V | Call for P/N | 369627 | 330412 | 4040115 | 4040060 | 330410 (1/4) 330416 (3/8) | 291603723 |
| 12000 | 220V | 293013036 | 331235 | 330412 | 333597 | 4040060 | 330410 (1/4) 330416 (3/8) | 291603723 |
| 16000 | 220V | 293045012 | 331235 | 330559 | 333360 | 4040060 | 330410 (1/4) 330417 (1/2) | 291603723 |
| | | | | | | | | |
| 6000 | 230V | 293013031 | 369627 | 330412 | 4040115 | 4040060 | 330410 (1/4) 330416 (3/8) | 291603723 |
| 9000 | 230V | 293013033 | 369627 | 330412 | 4040115 | 4040060 | 330410 (1/4) 330416 (3/8) | 291603723 |
| 12000 | 230V | 293013035 | 331235 | 330412 | 333597 | 4040060 | 330410 (1/4) 330416 (3/8) | 291603723 |
| 16000 | 230V | 293013037 | 331235 | 330559 | 333360 | 4040060 | 330410 (1/4) 330417 (1/2) | 291603723 |
| 24000 | 230V | 293045638 | 298001293 | 4040075 | 4040130 | 4128010 | 330416 (3/8) 330694 (5/8) | 291602794 |

| CSD/CSM Capacity | Voltage | Circuit Board | Display Cable |
|-------------------------|----------------|----------------------|----------------------|
| All Sizes | All Voltages | 223100502 | 222103020 |

Stowaway S-F and Zephyr ZF Self Contained Parts

Stowaway V Replacement Parts - Recip. Compressors

| Model | Size (Btu/hr) | Capacitors | | Start Relay | Rev. Valve | RV Solenoid | Repl. Cond | Repl. Comp | Comp. Overload |
|----------------------|------------------|------------|---------|----------------|---------------|----------------|---------------|---------------|-------------------|
| | | Run | Start | | | | | | |
| 115V | | | | | | | | | |
| SH,SX7 | 7000 | 4040115 | 330412 | 4040060 | 701820245 | 4071501 | R3600-S7 | 293045657 | 331406 |
| SH,SX10 | 10000 | 333360 | 330412 | 4040060 | 701820242 | 4071502 | R3600-S10 | 293045668 | 048900 |
| SH,SX12 | 12000 | 333360 | 4040543 | 4040060 | 701820242 | 4071502 | R3600-S12 | 293045656 | 049000 |
| SH,SX16 | 16000 | 331475 | 4040543 | 4040060 | 701820242 | 4071502 | R3600-S16 | 293045644 | 331404 |
| 230V | | | | | | | | | |
| SH,SX7C | 7000 | 4040115 | 330412 | 4040060 | 701820245 | 4071601 | R3600-S7 | 293045661 | 331407 |
| SH,SX10C | 10000 | 4040115 | 330412 | 4040060 | 701820242 | 4071602 | R3600-S10 | 293045669 | 049200 |
| SH,SX12C | 12000 | 4040115 | 4040543 | 4040060 | 701820242 | 4071602 | R3600-S12 | 293045665 | 049300 |
| SH,SX16C | 16000 | 338455 | 4040543 | 4040060 | 701820242 | 4071602 | R3600-S16 | 293045645 | 331405 |
| SH,SX24C | 24000 | 4040130 | 330559 | 4040060 | 701820244 | 4071602 | N/A | 293045703 | Internal |
| SH,SX24C3* | 24000 | 333360 | 4040206 | 4040060 | 701820244 | 4071602 | N/A | 293045703 | Internal |
| 220-240V 50Hz | | | | | | | | | |
| SH,SX7CK | 7000 | 4040115 | 330412 | 4040060 | 701820245 | 4071601 | R3600-S7 | N/A | 046500 |
| SH,SX10CK | 10000 | 4040115 | 330412 | 4040060 | 701820242 | 4071602 | R3600-S10 | N/A | 046600 |
| SH,SX12CK | 12000 | 4040115 | 4040543 | 4040060 | 701820242 | 4071602 | R3600-S12 | 293045670 | 046700 |
| SH,SX16CK | 16000 | 333360 | 4040543 | 4040060 | 701820242 | 4071602 | R3600-S16 | N/A | N/A |
| SH,SX24CK | 24000 | 331475 | 330559 | 4040060 | 701820244 | 4071602 | N/A | 293045703 | Internal |
| SH,SX24CK3* | 24000 | 331475 | 4040206 | 4040060 | 701820244 | 4071602 | N/A | 293045703 | Internal |

Note: Model numbers ending in "3" use H23 compressors. Replacement compressors ending in "3" include both capacitors and the start relay.

Stowaway V Replacement Parts - Rotary Compressors

| Model | Size (Btu/hr) | Capacitors | | Start Relay | Rev. Valve | RV Solenoid | Repl. Cond | Repl. Comp | Comp. Overload |
|----------------------|------------------|------------|--------|----------------|---------------|----------------|---------------|---------------|-------------------|
| | | Run | Start | | | | | | |
| 115V | | | | | | | | | |
| SHR, SXR7 | 7000 | 4040115 | 330559 | 4040060 | 701820245 | 4071501 | R3600-S7 | N/A | 332849 |
| SHR, SXR10 | 10000 | 4040130 | 330559 | 4040060 | 701820242 | 4071502 | R3600-S10 | 293045651 | 332852 |
| SHR, SXR12 | 12000 | 4040130 | 330559 | 4040060 | 701820242 | 4071502 | R3600-S12 | 293045655 | 332855 |
| SHR, SXR16 | 16000 | 4040130 | 330559 | 4040060 | 701820242 | 4071502 | R3600-S16 | 293045642 | 332858 |
| 230V | | | | | | | | | |
| SHR, SXR7C | 7000 | 4040140 | 330559 | 4040060 | 701820245 | 4071601 | R3600-S7 | 293045660 | 332851 |
| SHR, SXR10C | 10000 | 4040130 | 330559 | 4040060 | 701820242 | 4071602 | R3600-S10 | 293045659 | 046807 |
| SHR, SXR12C | 12000 | 4040130 | 330559 | Call for PN | 701820242 | 4071602 | R3600-S12 | 293045672 | 046801 |
| SHR, SXR16C | 16000 | 4040130 | 330559 | Call for PN | 701820242 | 4071602 | R3600-S16 | 293045652 | 046801 |
| 220-240V 50Hz | | | | | | | | | |
| SHR, SXR7CK | 7000 | 4040115 | - | - | 701820245 | 4071601 | R3600-S7 | N/A | N/A |
| SHR, SXR10CK | 10000 | 4040130 | 330559 | 4127500 | 701820242 | 4071602 | R3600-S10 | N/A | 046808 |
| SHR, SXR12CK | 12000 | 4040130 | 330559 | 4127500 | 701820242 | 4071602 | R3600-S12 | N/A | 046805 |
| SHR, SXR16CK | 16000 | 4040130 | 330559 | 4127500 | 701820242 | 4071602 | R3600-S16 | 293045673 | 046801 |

Note: Newer SXR SMXII rotary units use a PTCR start assist (# 335055) instead of a start capacitor and start relay, except for 7k models which have no start assist device. The customer will need to know whether or not their unit has either the Start Cap & Relay or the PTCR.

Notes:

1. High pressure switch for SH and SHR units: 297000050 (line duty)
2. High pressure switch for SX and SXR units: 297000048
3. Low pressure switch for SX and SXR units: 297000047

Reversing Valves & Solenoid Coils: See "Replacement Reversing Valves" section of this book and Field Notice #FNR233-I4 before ordering RV's or Coils. When ordering a new RV for an old unit, you must also order a new coil and vice versa.

CHECK PRICING AND AVAILABILITY BEFORE PLACING AN ORDER.

Stowaway SXF, SHF and Zephyr ZF Replacement Parts Table

Stowaway SHF/SXF

| MODEL SXF/SHF (BTU/HR) | Blower Assy | Compressor Assy | Evap Coil | Evap Coil Assy | Condenser Coil Assy | Strainer with Cap Tube | Overloads |
|------------------------|-------------|-----------------|-----------|----------------|---------------------|------------------------|--------------|
| 115V | | | | | | | |
| 5 | 240110095 | 239402000 | 332062 | 239401019 | N/A | 335466 | N/A |
| 7 | 293042076 | N/A | 333278 | 293044121 | 293044033 | 332343 | 332849 |
| 7/2 | 293042076 | N/A | 333278 | 293044121 | 293044033 | 332343 | 4120008 |
| 10 | 293042080 | 293045613 | 333279 | 293047009 | 293044034 | 332342 | 332852 |
| 10-1 | 293042080 | 293045623 | 335510 | 293044256 | 293044034 | 332342 | 335571 |
| 12 | 293042080 | 293045051 | 333281 | 293044123 | 293044035 | 332341 | 332855 |
| 12-1 | 293042080 | 293045179 | 335476 | 293044257 | 293044035 | 332341 | 335574 |
| 12/2 | 293042080 | N/A | 335476 | 293044257 | 293044035 | 332341 | 4120007 |
| 16 | 293042031 | 293045053 | 333281 | 293044124 | 293044036 | 332340 | 332858 |
| 16/2 | 293042031 | 239402063 | N/A | N/A | 293044036 | 332340 | 4120027 |
| 230V | | | | | | | |
| 7C | 239400014 | N/A | 333278 | 293044121 | 293044033 | 332343 | 332850 |
| 10C | 293042081 | 293045614 | 333279 | 293047009 | 293044034 | 332342 | Call for P/N |
| 10C-1 | 293042081 | 239402008 | 335510 | 293044256 | 293044034 | 332342 | Call for P/N |
| 10C/2 | 293042081 | 239402008 | 335510 | 293044256 | 293044034 | 332342 | 4120010 |
| 12C | 293042081 | 293045051 | 333281 | 293044123 | 293044035 | 332341 | Call for P/N |
| 12C-1 | 293042081 | Call for P/N | 335476 | 293044257 | 293044035 | 332341 | 335573 |
| 12C/2 | 293042081 | 239402011 | 335476 | 293044257 | 293044035 | 332341 | 4120007 |
| 16C | 293042049 | 293045054 | 333281 | 293044124 | 293044036 | 332340 | 332859 |
| 16C/2 | 293042049 | 239402058 | N/A | N/A | 293044036 | 332340 | 4120027 |
| 220V | | | | | | | |
| 7CK | 239400014 | 293045140 | 333278 | 293044121 | 293044033 | 332343 | |
| 10CK-1 | 293042081 | Call for P/N | 335510 | 293044256 | 293044034 | 332342 | 335573 |
| 12CK | 293042081 | 293045055 | 335476 | 293044257 | 293044035 | 332341 | 335575 |
| 16CK | 293042049 | 293045112 | N/A | N/A | 293044036 | 332340 | 332860 |

Notes:

1. When replacing compressor, add run capacitor 331475 and molded plug harness 334800 for units manufactured through 1998.
2. When replacing compressor, add molded plug harness 334800 for units manufactured between June 1198 and December 2000.
3. For units manufactured after December 2000, only painted compressor is required.

Zephyr ZF

| MODEL ZF (BTU/HR) | Units Built | Voltage | Compressor |
|-------------------|--------------|---------|------------|
| 10 | Thru Feb.'03 | 115V | 3014010 |
| 10-1 | From Mar.'03 | 115V | 335495 |
| 12 | Thru Feb.'03 | 115V | 331258 |
| 12-1 | From Mar.'03 | 115V | 3014512 |
| 16 | Thru Feb.'03 | 115V | 3014016 |
| 10C | Thru Feb.'03 | 230V | 3014110 |
| 12C | Thru Feb.'03 | 230V | 3014112 |

"R" Type Condenser Replacement Parts

| "R" Type Remote Condensing Unit (5-16K) Replacement Parts | | | | | | | | |
|------------------------------------------------------------------|-----------|---------------|-----------|-----------------|------------|----------|-----------|---------|
| | Repl | Run Capacitor | | Start Capacitor | | Comp | Repl | RV |
| Model | Comp | p/n | mfd/volts | p/n | mfd/volts | Overload | RV | Coils |
| R5 | 293045654 | 4040115 | 15/400V | 330412 | 21-25/330V | 049600 | 701820245 | 4071501 |
| R7 | 293045650 | 4040115 | 15/400V | 330412 | 21-25/330V | 331406 | 701820245 | 4071501 |
| R10 | 293045658 | 333360 | 25/370V | 330412 | 21-25/330V | 048900 | 701820243 | 4071502 |
| R12 | 293045647 | 333360 | 25/370V | 4040543 | 43-53/330V | 049000 | 701820243 | 4071502 |
| R16 | 293045640 | 331475 | 35/370V | 4040543 | 43-53/330V | 331404 | 701820243 | 4071502 |
| R7C | 293045641 | 4040115 | 15/400V | 330412 | 21-25/330V | 331407 | 701820245 | 4071601 |
| R10C | 293045648 | 4040115 | 15/400V | 330412 | 21-25/330V | 049200 | 701820243 | 4071602 |
| R12C | 293045646 | 4040115 | 15/400V | 4040543 | 43-53/330V | 049300 | 701820243 | 4071602 |
| R16C | 293045643 | 333597 | 20/370V | 4040543 | 43-53/330V | 331405 | 701820243 | 4071602 |
| R7CK | 293045671 | 4040115 | 15/400V | 330412 | 21-25/330V | 046500 | 701820245 | 4071601 |
| R10CK | N/A | 4040115 | 15/400V | 330412 | 21-25/330V | 046600 | 701820243 | 4071602 |
| R12CK | 293045684 | 4040115 | 15/400V | 4040543 | 43-53/330V | 046700 | 701820243 | 4071602 |
| R16CK | 293045680 | 333360 | 25/370V | 4040543 | 43-53/330V | N/A | 701820243 | 4071602 |

Start Relays: All R5-16 models (115V & 230V) may use the Universal Replacement Start Relay (4040060)

| "R" Type Remote Condensing Unit (20-48K) Replacement Parts | | | | | | | | |
|-------------------------------------------------------------------|-----------|-----------|-----------|---------------|-----------|-----------------|--------------|-------------|
| | Repl | RV | Cond | Run Capacitor | | Start Capacitor | | Start Relay |
| Model | Comp | Assembly | Assy | p/n | mfd/volts | p/n | mfd/volts | p/n |
| R20C | 293045686 | 701820240 | N/A | 4040130 | 30/370V | 332475 | 161-193/250V | 4136050 |
| R24C | 293045703 | 701820240 | 3062024 | 4040130 | 30/370V | 4040075 | 145-175/250V | 4040060 |
| R30C | 293045664 | 701830360 | 293045682 | 331475 | 35/370V | 4040075 | 145-175/250V | 4040060 |
| R36C | 293045675 | 701830360 | N/A | 330855 | 40/370V | 4040075 | 145-175/250V | 4040060 |
| R48C | 298001563 | 701820246 | 701842482 | 4040155 | 55/370V | 4040206 | 88-108/330V | 4040060 |
| R20CK | 298001543 | 701820240 | N/A | 331475 | 35/370V | 4040075 | 145-175/250V | 298001216 |
| R24CK | N/A | 701820240 | 3062024 | 331475 | 35/370V | 4040075 | 145-175/250V | 298600007 |
| R30CK | 293045667 | 701830360 | 293045682 | 330855 | 40/370V | 4040075 | 145-175/250V | 298001157 |
| R36CK | 3018836* | 701830360 | N/A | 330855 | 40/370V | 4040075 | 145-175/250V | 298001216 |
| R48CK | 3015342* | 701820246 | 701842482 | 4040160 | 60/370V | 331733 | 270-324/330V | 298001141 |
| R24D(C) | 3015120* | 701820240 | 3062024 | | | | | |
| R30D(C) | N/A | 701830360 | 293045682 | | | | | |
| R36D(C) | 293045215 | 701830360 | N/A | | | | | |
| R48D(C) | 293045683 | 701820246 | 701842482 | | | | | |
| R24E(C) | N/A | 701820240 | 3062024 | | | | | |
| R30E(C) | 3000128* | 701830360 | 293045682 | | | | | |
| R36E(C) | 3019131* | 701830360 | N/A | | | | | |
| R48E(C) | 3015242* | 701820246 | 701842482 | | | | | |
| R20ECK | N/A | 701820240 | N/A | | | | | |
| R24ECK | 336063 | 701820240 | 3062024 | | | | | |
| R30ECK | 3019131* | 701830360 | 293045682 | | | | | |
| R36ECK | 3019137* | 701830360 | N/A | | | | | |
| R48ECK | 3015249* | 701820246 | 701842482 | | | | | |

*Raw Compressor Part Number

Start Relays: All R5-16 models (115V & 230V) may use the Universal Replacement Start Relay (4040060)

| Contactors for 3 Phase Compressors Only | | |
|------------------------------------------------|---------|-----------------------------------|
| 115V Coil | 4130830 | All D & E models w/115V control |
| 230V coil | 4130630 | All DC & EC models w/230V control |

| Condenser Seawater Manifolds | | |
|-------------------------------------|-----------|----------------------|
| R30 | 720243000 | water in |
| R30 | 720243001 | water out |
| R36 | 720303600 | in/out (order qty 2) |
| R48 | 720424800 | in/out (order qty 2) |

| Base Valves | |
|--------------------|--------------------------------|
| 3080106 | Base Valve 3/8 |
| 3080204 | Base Valve 1/4 |
| 3080808 | Base Valve 1/2 |
| 3081206 | Base Valve 3/8 with Purge Port |
| 330642 | Cap Access (Cap Only) |
| 3121301 | Cap Valox Base Valve Stem |

Modulating Condenser Replacement Parts

"RM" Type Remote Modulating Condensing Unit Replacement Parts

| Model | Repl | Repl Cond | Run Capacitor | | Start Capacitor | | Start Relay |
|----------|-----------|-----------|---------------|-----------|-----------------|-------------|-------------|
| | Comp | Assy | p/n | mfd/volts | p/n | mfd/volts | p/n |
| RM24C | 293045207 | 293045682 | 330855 | 40/370 | 4040206 | 88-106 330V | 4040060 |
| RM30C | 298001553 | N/A | 331475 | 35/440 | 4040206 | 88-106 330V | 4040060 |
| RM42C | 298001563 | 701842482 | 4040155 | 55/370 | 4040206 | 88-106 330V | 4040060 |
| RM24CK | 298001305 | 293045682 | 4040145 | 45/370 | 4040206 | 88-106 330V | 4040060 |
| RM30CK | 298001305 | N/A | 333026 | 50/370 | 4040206 | 88-106 330V | 4040060 |
| RM42CK | N/A | 701842482 | 4040160 | 60/370 | 331733 | 270-324/330 | Call for PN |
| RM24D(C) | 298001360 | 293045682 | | | | | |
| RM30D(C) | 293045237 | N/A | | | | | |
| RM42D(C) | 293045683 | 701842482 | | | | | |

| Contactors for 3 Phase Compressors only | | | |
|-----------------------------------------|-----------|--------------------------------------|--------------------------|
| 120V Coil | 4130830 | All D & E models with 120V control | |
| 230V Coil | 4130630 | All DC & EC models with 230V control | |
| Condenser Seawater Manifolds | | | |
| RM24 | 720243000 | water in | |
| RM24 | 720243001 | water out | |
| RM30 | 720303600 | in/out (order qty 2) | |
| RM42 | 720424800 | in/out (order qty 2) | |
| RM Control Parts | | | |
| All RM Units | | 4143775 | Resistor 7.5K OHM 10W |
| All RM Units | | 4135502 | Time Delay 18-240V |
| All RM Units | | 4220047 | Relay PC Board A-550 |
| All RM Units | | TR230 | Relay Trigger 230V |
| RM24C - RM42C | | 4134200 | Relay Solid State 75 amp |

DX Replacement Parts Index

ACCUMULATORS

| Part # | List Price (USD) | Description |
|---------------|-------------------------|-----------------------------------------------------------|
| 331322 | \$43.00 | Accumulator (used on all CS6-16K and KRA425C, KRA450C) |
| 333150 | \$160.00 | Accumulator (used on all CS24K - CS36K & Emeralds 24-36K) |
| 3160401 | \$135.00 | Accumulator (used on all CS48K - CS60K & Emeralds 48-72K) |

BASE VALVE

| | | |
|--------|----------|---------------------------|
| 330410 | \$75.00 | Valve, Base 1/4F X 1/4S B |
| 330416 | \$90.00 | Valve, Base 3/8F X 3/8S B |
| 330417 | \$110.00 | Valve, Base 1/2F X 1/2S B |
| 330694 | \$130.00 | Valve, Base 5/8F X 5/8S B |

BLOWERS

| | | |
|-----------|----------------|--------------------------------------------------|
| 2053405 | \$190.00 | Blower Wheel/Housing EBD/E30-36K |
| 2053410 | \$330.00 | Blower Wheel/Housing EBD48 |
| 2053430 | \$495.00 | Blower Wheel/Housing FPV60 50HZ |
| 2054310 | \$410.00 | Blower, 830CFM 230V50/60 FO |
| 239400014 | \$620.00 | Blower w/Capacitor VC7Z-HV |
| 239400027 | \$750.00 | Blower High Velocity w/Capacitor VC18K-HV, 115V |
| 239400047 | \$750.00 | Blower High Velocity w/Capacitor VC18KZ-HV, 230V |
| 239400052 | \$235.00 | Blower Assy Turbo 6K 115V |
| 239400053 | \$235.00 | Blower Assy Turbo 6K 220/230V |
| 239400054 | \$265.00 | Blower Assy Turbo 8K 115V |
| 239400055 | \$265.00 | Blower Assy Turbo 8K 220V/230V |
| 239400056 | \$315.00 | Blower Assy Turbo 10-12K 115V |
| 239400057 | \$315.00 | Blower Assy Turbo 10-12K 220/230 |
| 239400058 | \$360.00 | Blower Assy Turbo 14-16K 115V |
| 239400059 | \$360.00 | Blower Assy Turbo 14-16K 220/230 |
| 239400063 | \$235.00 | Blower Assy, ECD/ECM 5K-HV, 115V |
| 239400064 | Call For Price | Blower Assy, ECD/ECM 6.5K-HV, 115V |
| 239400065 | \$300.00 | Blower Assy, ECD/ECM 9K-HV, 115V |
| 239400066 | Call For Price | Blower Assy, ECD/ECM 11K-HV, 115V |
| 239400067 | \$335.00 | Blower Assy, ECD/ECM 15K-HV, 115V |
| 293042209 | \$590.00 | Blower Assy VCD/SF5 115V F to HV |
| 240110095 | \$615.00 | Blower High Velocity w/Capacitor SF5 115V |
| 293042031 | \$805.00 | Blower High Velocity w/Capacitor SF16 115V |
| 293042049 | \$805.00 | Blower High Velocity w/Capacitor SF16 230V |
| 293042076 | \$640.00 | Blower High Velocity w/Capacitor SF7 115V |
| 293042080 | \$685.00 | Blower High Velocity w/Capacitor SF10-12 115V |
| 293042081 | \$685.00 | Blower High Velocity w/Capacitor SF10-12 230V |

DX Replacement Parts Index

BLOWERS Continued

| <u>Part #</u> | <u>List Price (USD)</u> | <u>Description</u> |
|---------------|-------------------------|----------------------------------------------------------------------------|
| 293042219 | Call For Price | Blower INS w/Capacitor E4FD-HV 115V |
| 293042211 | Call For Price | Blower INS w/Capacitor E4FDZ-HV 230V |
| 293042210 | \$665.00 | Blower INS w/Capacitor E6FD-HV 115V |
| 293042212 | Call For Price | Blower INS w/Capacitor E6FDZ-HV 230V |
| 293042213 | \$705.00 | Blower INS w/Capacitor E9FD-HV 115V |
| 293042214 | \$695.00 | Blower INS w/Capacitor E9FDZ-HV 230V |
| 293042218 | \$750.00 | Blower INS w/Capacitor E12FD-HV 115V |
| 293042215 | \$755.00 | Blower INS w/Capacitor E12FD/1-HV 115V |
| 293042216 | \$705.00 | Blower INS w/Capacitor E12FDZ-HV 230V |
| 293042217 | \$710.00 | Blower INS w/Capacitor E12FDZ/1-HV 230V |
| 291617060 | \$745.00 | Blower INS w/Capacitor E16FD-HV 115V |
| 291617061 | \$710.00 | Blower INS w/Capacitor E16FDZ-HV 230V |
| 239400039 | \$660.00 | Blower E9FD-HV, w/5" mount ring 115V |
| 239400045 | \$685.00 | Blower E12KZ/1HV, w/6" mount ring 230V |
| 239400042 | \$775.00 | Blower E16FDZ-HV, w/7" mount ring 230V - works on both 16K and 16K/1 units |
| 293042221 | \$1,230.00 | Blower Assy Retro VCD24 FZ to HVZ** |
| 715210504 | \$655.00 | Blower Assy 4/5K HIEFF REU4/5C 230V |
| 715212416 | \$625.00 | Blower 4/5K PLSTC HV, REU4/5K 115V |
| 715212400 | \$830.00 | Blower Assy RE/REU24C HI EFF 230V |
| 725210514 | \$1,675.00 | Blower RE30/36 230V |
| 715212412 | \$660.00 | Blower FA3-6 115V |
| 715212407 | \$660.00 | Blower FA3-6C 230V |
| 715212414 | \$660.00 | Blower FA7.5 & 9 115V |
| 715212410 | \$660.00 | Blower FA7.5 & 9C 230V |
| 715212413 | \$710.00 | Blower FA-12 115V |
| 715212408 | \$710.00 | Blower FA12C 230V |
| 715212409 | \$750.00 | Blower FA15/18 115V |
| 715212406 | \$750.00 | Blower FA15/18C 230V |
| 715212423 | \$745.00 | Blower Assy EBE24-230V w/cap |
| 715212424 | \$750.00 | Blower Assy EBE18-230V w/cap |
| 239400092 | \$915.00 | Blower EBE30-230V 10"MR |
| 715212428 | \$780.00 | Blower Assy EBDE36-230V w/cap |
| 715212430 | \$1,095.00 | Blower Assy EBDE48-220V w/cap |
| 715212429 | \$1,020.00 | Blower Assy EBDE72-220V w/cap |

CAPACITORS

Start Capacitors

| | | |
|--------|---------|-------------------------------------------------------------------------------|
| 334867 | \$41.00 | Capacitor Hard Start with Relay |
| 330412 | \$21.00 | Capacitor START 21-25MFD/330V SH & SX7, 10, R/RX/RN,RQ 5,7,10, SQUF30, VECU18 |
| 330559 | \$35.00 | Capacitor START 72-88MFD/330V W/BR for all Stowaway V Rotary Compressors |
| 331733 | \$75.00 | Capacitor START 270-324/330V W/BR RM42CK / R48CK |
| 332475 | \$90.00 | Capacitor START 161-193/330V W/BR EM30/36 220V; 161-193/250 V R(X,N) 20K 417A |

DX Replacement Parts Index

CAPACITORS Continued

Start Capacitors Continued

| <u>Part #</u> | <u>List Price (USD)</u> | <u>Description</u> |
|---------------|-------------------------|---------------------------------------------------------------------------|
| 335760 | \$70.00 | Capacitor START 189-227/250V EM36 230V |
| 3100236.24 | \$6.73 | Capacitor START VCD18K |
| 4040070 | \$105.00 | Capacitor START High Torque FX48, MTC(S) 48K & 60K |
| 4040075 | \$38.00 | Capacitor START 145-175UF@250V W/BLE SH(N)24, R(X,N,Q) 20-36K |
| 4040076 | \$65.00 | Capacitor START 145-175/330V W/O BR EM24K / EM30K 230V / EM48K 220V |
| 4040106 | \$75.00 | Capacitor START 88-108/330V W/O BR EM48 230V |
| 4040206 | \$33.00 | Capacitor START 88-106 MR W/15 OHM SH/SX24C3 / SHSX24CK3 / R48C / RM24-30 |
| 4040543 | \$23.00 | Capacitor START 43-53 MFD. 330 VAC 60 (UL) CSD/CSM/SH/SX12C |
| 298001296 | \$33.00 | Capacitor START 43-53 MFD 220V |

Run Capacitors

| | | |
|---------|---------|---------------------------------------------------------------------------------------------------------------------|
| 330855 | \$23.00 | Capacitor RUN 40MFD/370VAC Emerlads 10K 115V & 36K 230V, SHR/SXR7-12, VCD27, SQUF27, CHCG20, R(N,Q,X) 30-36k, RM24K |
| 331475 | \$20.00 | Capacitor RUN 35MFD/370V CSD(M)6-8K, ED(M)6,8,12 115V/EM24-30K 230V/EM24 220V /R16/R30C/R20-24CK |
| 331520 | \$34.00 | Capacitor RUN 55MFD/440V ROUND EM36 220V / EM48 230V |
| 331523 | \$33.00 | Capacitor RUN 45MFD/440V EM30 220V |
| 333026 | \$26.00 | Capacitor RUN 50MFD/370V RM30 220V, TWLC, CWMC |
| 333360 | \$19.00 | Capacitor RUN 25MFD/370V CSD(M)16K 220V, ED/EM16K 220V, R/SH/SX10-12 115V, SH/SX/R16CK 220V, Eskimo Ice |
| 333597 | \$20.00 | Capacitor RUN 20MFD/370V ED(M,Q)12K, R(X,Q)16C, SX16C, CSD(M) 12K 230V, ECD3.5 |
| 334145 | \$39.00 | Capacitor RUN 80MFD/370V EQ72, TWC48 & 60, MCG60 |
| 335802 | \$36.00 | Capacitor RUN 60MFD/440V EM48 220V |
| 4040115 | \$17.00 | Capacitor RUN 15 MFD 400/440V SH/SX7, 7C, 10C, 12C, CSD(M)6-9K, EBDE72K |
| 4040130 | \$18.00 | Capacitor RUN 30MFD/370V EM16K 230V, SH/SX24C, SHR/SXR10-16 all voltages, R20-24C |
| 4040145 | \$24.00 | Capacitor RUN 45MFD 370VAC 60HZ ED(M)16K, RM24CK, VCD18K 220/230V |
| 4040155 | \$30.00 | Capacitor RUN 55MFD/370V R48C, RM42C, FM42CK |
| 4040160 | \$34.00 | Capacitor RUN 60 MFD 370VAC R(N,Q)48CK, CHCG24 |
| 4040185 | \$70.00 | Capacitor RUN 80MFD/440V RX,RQ 48, CWMC |
| 4041004 | \$31.00 | Capacitor RUN 4 MF 370V EBS16, EBS16C |
| 4041005 | \$29.00 | Capacitor RUN 5.0MFS/370V EBDE36K-48K 230V |
| 4041007 | \$17.00 | Capacitor RUN 7.5 MF 370V EBDE36K-72K 220V |

Dual Capacitors

| | | |
|---------|---------|---------------------------------------------------------------------------|
| 4040028 | \$25.00 | Capacitor DUAL 35MFD/6MFD 240V R410A & R417A TURBO/ECD(M) 6K 115V |
| 4040034 | \$24.00 | Capacitor DUAL 20MFD/2MFD 370V R417A TURBO 6K 220V |
| 337048 | \$27.00 | Capacitor DUAL 15MFD/2MFD 440V R410A 2.56" TURBO/ECD 6K 220/230V |
| 4040031 | \$24.00 | Capacitor DUAL 30MFD/15MFD 370V TURBO 8, 115V |
| 4040042 | \$30.00 | Capacitor DUAL 35MFD/16MFD 250V R410A & R417A TURBO 8K 115V |
| 4040040 | \$25.00 | Capacitor DUAL 15MFD/4MFD 440V R410A TURBO 8K 230V & 220V |
| 4040029 | \$26.00 | Capacitor DUAL 40MFD/10MFD 240V R410A Turbo 10K & R417A Turbo 10-12K 115V |
| 338293 | \$9.18 | Capacitor DUAL 15MFD/3MFD 440V R410A Turbos 10K 230V & 220V |
| 4040035 | \$26.00 | Capacitor DUAL 25MFD/3MFD 370V R417A TURBO 10K 220V |
| 4040037 | \$26.00 | Capacitor DUAL 30MFD/3MFD 370V R417A TURBO 12K 115V |

DX Replacement Parts Index

CAPACITORS Continued

Dual Capacitors Continued

| <u>Part #</u> | <u>List Price (USD)</u> | <u>Description</u> |
|---------------|-------------------------|------------------------------------------------------------------------------|
| 4040052 | \$33.00 | Capacitor DUAL 35MFD/10MFD 370V R410A TURBO 12K 115V |
| 4040041 | \$25.00 | Capacitor DUAL 20MFD/3MFD 440V R410A TURBO 10-12K 220V/230V & R417A 12K 220V |
| 337047 | \$31.00 | Capacitor DUAL 45MFD/16MFD 370V R410A TURBO/ECD(M) 16K 115V |
| 4040038 | \$29.00 | Capacitor DUAL 30MFD/4MFD 370V TURBO 14-16, 230V 60 Hz |
| 4040039 | \$29.00 | Capacitor DUAL 30MFD/16MFD 370V R417A TURBO 16K 115V |
| 4040043 | \$24.00 | Capacitor DUAL 30MFD/5MFD 370V R410A & R417A TURBO 16K 230V |
| 4040044 | \$24.00 | Capacitor DUAL 25MFD/5MFD 370V R410A & R417A TURBO 16K 220V |

Blower Capacitors

| | | |
|---------|---------|---------------------------------------------------------------------------------------|
| 331027 | \$24.00 | Capacitor 20MFD WIRE W/8MM STUD 250 RE/REU16 115V, VCD18K 115V |
| 331103 | \$18.00 | Capacitor 2MFD WIRE W/8MM STUD 425- TV/EBE/EBHE4-6K 230V |
| 330669 | \$23.00 | Capacitor 10MFD WIRE W/8MM STUD 250 TV10-12 RE/REU10,12 RE/REU30C, HSA16 |
| 330670 | \$21.00 | Capacitor 3MFD WIRE W/8MM STUD 425- TV10-12K 230V, HSA16UKC, PHD12HVZ, EBHE12, |
| 330750 | \$21.00 | Capacitor, 16MFD WIRE W/8MM STUD 250 TV8K 14K & 16K 115V |
| 2052501 | \$22.00 | Capacitor 4MFD WIRE W/8MM STUD 400V TV/RE/REU7-8K 230V, EBE/EBHE 6K 230V |
| 2052701 | \$23.00 | Capacitor 16MF RE/REU7, 8, 12 115V |
| 2053101 | \$21.00 | Capacitor 6MFD/400V TV4-6K 115V, EBE/EBHE/VCD 18K 220/230V |
| 4040045 | \$21.00 | Capacitor 5MFD WIRE W/8MM STUD&NUT TV14-16K 230V, EBE/EBHE14-16K 230V |
| 4040058 | \$23.00 | Capacitor 8MFD WIRE W/8MM STUD RE/REU4-5K 115V RE/REU24K 230V, EBE/EBHE18-30K, VCD27K |

COMPRESSORS

| | | |
|-----------|----------------|---------------------------------------------------|
| 239402000 | \$535.00 | Compressor 115V for SF5/2 |
| 239402011 | \$630.00 | Compressor 230V for SF12C/2 |
| 239402063 | \$900.00 | Compressor 115V for SF16, VC16/2 w/overload |
| 239402016 | \$815.00 | Compressor 220V for SF18CK/2 |
| 298001186 | \$1,610.00 | Compressor Painted ZP21K5E 2361 410 27K units |
| 239402020 | \$520.00 | Compressor Turbo/EC6K 115V W/OVRLD-HRDW |
| 239402021 | \$565.00 | Compressor Turbo 6K 220V w/Overload and Hardware |
| 239402029 | \$555.00 | Compressor Turbo 12K 230V w/Overload and Hardware |
| 239402030 | \$570.00 | Compressor Turbo 12K 220V w/Overload and Hardware |
| 239402035 | \$580.00 | Compressor Turbo 16K 230V w/Overload and Hardware |
| 239402036 | \$735.00 | Compressor Turbo 16K 220V w/Overload and Hardware |
| 239402044 | Call For Price | Compressor Turbo 6K-410 115V W/OVRLD |
| 239402045 | \$500.00 | Compressor Turbo 6K-410 230/60V/OVRLD |
| 239402046 | \$495.00 | Compressor Turbo 8K-410 115V W/OVRLD |

DX Replacement Parts Index

COMPRESSORS Continued

| Part # | List Price (USD) | Description |
|---------------|-------------------------|--------------------------------------------------------------------------------------------------------|
| 239402047 | \$510.00 | Compressor Turbo 8K-410 230V W/OVRD |
| 239402048 | \$510.00 | Compressor Turbo 6/8K-410 220/50 W/OVRD |
| 239402049 | \$490.00 | Compressor Turbo 10K-410 115V W/OVRD |
| 239402050 | \$510.00 | Compressor Turbo 10K-410 230V W/OVRD |
| 239402051 | \$525.00 | Compressor Turbo 10K-410 220/50 W/OVRD |
| 239402052 | \$505.00 | Compressor Turbo 12K-410 115V W/OVRD |
| 239402053 | \$525.00 | Compressor Turbo 12K-410 230V W/OVRD |
| 239402054 | \$525.00 | Compressor Turbo 12K-410 220/50 W/OVRD |
| 239402055 | \$550.00 | Compressor Turbo 16K-410 115V W/OVRD |
| 239402056 | \$560.00 | Compressor Turbo 16K-410 230V W/OVRD |
| 239402057 | \$575.00 | Compressor Turbo 16K-410 220/50 W/OVRD |
| 239402060 | \$690.00 | Compressor VT16K-TECH 115V w/Overload and Hardware |
| 239402058 | \$885.00 | Compressor Painted 230V for SF16C/2 HSA16, SXR/SLX16 with overload |
| 239402061 | \$650.00 | Compressor EC16K-TECH 115V w/Overload and Hardware |
| 293013031 | \$595.00 | Compressor 230V for CS6KZ w/Hardware |
| 293013032 | \$590.00 | Compressor 115V for CS6K w/Hardware |
| 293013033 | \$630.00 | Compressor PNTD CS9KZ 230V w/Hardware |
| 293013034 | Call For Price | Compressor PNTD CS9K 115V w/Hardware |
| 293013035 | \$670.00 | Compressor PNTD CS12KZ 230V w/Hardware |
| 293013036 | \$665.00 | Compressor PNTD CS12K 115V w/Hardware |
| 293013037 | \$700.00 | Compressor PNTD CS16KZ 230V w/Hardware |
| 293013038 | \$680.00 | Compressor PNTD CS16K 115V w/Hardware |
| 293045702 | \$1,605.00 | Compressor PNTD 2T RE 230/1 H22J20BA CS24K |
| 293045215 | \$1,350.00 | Compressor Painted CSD36RZ3 230/50-60/3 |
| 293045012 | \$810.00 | Compressor Painted CS/VH16Z50 Replaces 293045674 for serial #s after 43497928 and dated after 08/28/14 |
| 293045613 | \$665.00 | Compressor 115V for SF10 (built thru Feb. '03) |
| 293045623 | \$635.00 | Compressor 115V for SF10-1 (built from Mar. '03) |
| 293045614 | \$680.00 | Compressor 230V for SF10C (built thru Feb. '03) |
| 293045051 | \$685.00 | Compressor 115V for SF12 (built thru Feb. '03) |
| 293045052 | \$705.00 | Compressor 230V for SF12C (built thru Feb. '03) |
| 293045053 | \$700.00 | Compressor 115V for SF16 |
| 293045054 | \$725.00 | Compressor 230V for SF16C |
| 293045055 | \$700.00 | Compressor 220V for SF12CK (built thru Feb. 03) |
| 293045112 | \$835.00 | Compressor 220V for SF16CK |
| 293045140 | \$660.00 | Compressor 220V for VC/SX 7K |
| 293045179 | \$635.00 | Compressor 115V for SF12/1 (built from Mar. '03) |
| 298001574 | \$1,940.00 | Compressor 230V for RM24C |
| 298001360 | \$2,075.00 | Compressor Painted 230/60/3 for RM24DC |
| 293045237 | Call For Price | Compressor Painted 230/60/3 for RM30DC |

DX Replacement Parts Index

COMPRESSORS Continued

| <u>Part #</u> | <u>List Price (USD)</u> | <u>Description</u> |
|---------------|-------------------------|--------------------------------------------------------------------------------------------------------------------------------------|
| 298001553 | \$2,620.00 | Compressor Painted 230/60/1 for RM30C |
| 298001305 | \$1,945.00 | Compressor Painted 220/50/1 for RM24CK & RM30CK |
| 3018821 | \$1,170.00 | Compressor, H22 20K 220-240/50/1 (RE36ECK) |
| 3019137 | \$1,670.00 | Compressor H22 36K 380/50/3 460/60/3 R36ECK |
| 293045684 | \$810.00 | Compressor CSD, R(Q,X) 12K 240 w/Tube and Drier |
| 239402062 | \$1,140.00 | Compressor Painted R3103-16 R-Type 16K unit 240/50/1 417A Replaces 293045674 for serial #s before 43497928 and dated before 08/28/14 |
| 293045686 | \$1,320.00 | Compressor R20C 230/60/1 |
| 293045703 | \$1,465.00 | Compressor R24C 230/60/1 |
| 293045682 | \$1,345.00 | Compressor R24CK 240/50/1 |
| 293045664 | \$1,500.00 | Compressor R30C 230/60/1 |
| 293045667 | \$1,400.00 | Compressor R30CK 240/50/1 |
| 293045675 | \$1,320.00 | Compressor R36C 230/60/1 |
| 298001563 | \$3,010.00 | Compressor R48C 230/60/1 |
| 293045683 | Call For Price | Compressor R48DC 230/60/3 |
| 293045654 | \$745.00 | Compressor Painted R3101-5T 115V 5K R417A R/RX/RN |
| 293045657 | \$700.00 | Compressor Painted R3101-7S 115V 6K R417A CS/SLX/SX/R/RX |
| 293045661 | \$720.00 | Compressor Painted R3102-7S 230V 7K 417A CS/SLX/SN/R/RX/RN/RQ |
| 293045651 | \$660.00 | Compressor Painted R3140-10S 115V 10K R417A CS/SLXR/SXR/SXF |
| 293045668 | \$745.00 | Compressor Painted R3101-10S 115V 10K R417A SLX/SN/SX/R/RX/RN/RQ |
| 293045659 | \$715.00 | Compressor Painted R3141-10S 230V 10K R417A SXR/SHR/SLX/SNR |
| 293045669 | \$750.00 | Compressor Painted R3102-10S 230V 10K R417A SLX/SN/SX/R/RX/RN/RQ |
| 293045655 | \$675.00 | Compressor Painted R3140-12S 115V 12K R417A SLX/SNR/SXR |
| 293045656 | \$750.00 | Compressor Painted R3101-12S 115V 12K R417A CS/SLX/R/RX/RN |
| 293045672 | \$675.00 | Compressor Painted R3141-12S 230V 12K R417A SLX/SX/SH/SN |
| 293045665 | \$755.00 | Compressor Painted R3102-12S 230V 12K R417A SLX/SN/SX/R/RX/RN/RQ |
| 293045642 | \$690.00 | Compressor Painted R3140-16S 115V 16K R417A SXR/VRD |
| 293045644 | \$755.00 | Compressor Painted R3101-16S 115V 16K R417A CS/SX/RX/SLX |
| 293045645 | \$755.00 | Compressor Painted R3102-16S 230V 16K R417A CS/SX/RX/SLX |
| 293045652 | \$695.00 | Compressor Painted R3141-16S 230V 16K R417A SXR/HSA/VC/SXF/VT/SXR |
| 293045673 | \$810.00 | Compressor Painted R3142-16S 240V 16K R417A SX/HSA/VC/VT/ST |
| 293045641 | \$745.00 | Compressor Painted R3102-7T 230V 6K R417A CS/RX |
| 293045650 | \$745.00 | Compressor Painted R3101-7T 115V 7K R417A CS/SLX/SX/RX |
| 293045646 | \$795.00 | Compressor Painted R3102-12T 230V 12K R417A CS/SX/SLX/RX/RN/RQ/RSC |
| 293045647 | \$785.00 | Compressor Painted R3101-12T 115V 12K R417A CS/SLX/SX/RX/RN |
| 293045648 | \$790.00 | Compressor Painted R3102-10T 230V 10K R417A CS/SLX/SX/RX/RN/RQ |
| 293045658 | \$785.00 | Compressor Painted R3101-10T 115V 10K R417A SLX/SN/SX/R/RX/RN/RQ |
| 293045643 | \$795.00 | Compressor Painted R3102-16T 230V 16K R417A CS/SX |
| 293045640 | \$795.00 | Compressor Painted R3101-16T 115V 16K R417A CS/RX |
| 293045671 | Call For Price | Compressor Painted R7CK R3103-7T 220V 7K R417A SX/R/RX/RN/RQ |
| 293013047 | \$540.00 | Compressor Painted EM6K 115V w/Grommets and Sleeves |
| 293013048 | Call For Price | Compressor Painted EM8K 115V w/Grommets and Sleeves |

DX Replacement Parts Index

COMPRESSORS Continued

| <u>Part #</u> | <u>List Price (USD)</u> | <u>Description</u> |
|---------------|-------------------------|----------------------------------------------------------------|
| 293013049 | \$515.00 | Compressor Painted EM10K 115V w/Grommets and Sleeves |
| 293013050 | Call For Price | Compressor Painted EM12K 115V w/Grommets and Sleeves |
| 293013051 | \$630.00 | Compressor Painted EM16K 115V w/Grommets and Sleeves |
| 293013052 | \$525.00 | Compressor Painted EM6K 230V w/Grommets and Sleeves |
| 293013053 | \$550.00 | Compressor Painted EM6-8K 220 & 8K 230V w/Grommets and Sleeves |
| 293013054 | \$570.00 | Compressor Painted EM10K 230V w/Grommets and Sleeves |
| 293013055 | \$580.00 | Compressor Painted EM12K 230V w/Grommets and Sleeves |
| 293013056 | \$605.00 | Compressor Painted EM16K 230V w/Grommets and Sleeves |
| 293013057 | \$570.00 | Compressor Painted EM10K 220V w/Grommets and Sleeves |
| 293013058 | \$575.00 | Compressor Painted EM12K 220V w/Grommets and Sleeves |
| 293013059 | Call For Price | Compressor Painted EM16K 220V w/Grommets and Sleeves |
| 293600504 | Call For Price | Compressor Painted EM24 230/60/1 w/Grommets and Sleeves |
| 293600505 | \$1,250.00 | Compressor Painted EM30 230/60/1 w/Grommets and Sleeves |
| 293600506 | \$1,350.00 | Compressor Painted EM36 230/60/1 w/Grommets and Sleeves |
| 293600508 | \$1,335.00 | Compressor Painted EM24 220/50/1 w/Grommets and Sleeves |
| 293600509 | \$1,545.00 | Compressor Painted EM30 220/50/1 w/Grommets and Sleeves |
| 293600510 | Call For Price | Compressor Painted EM36 220/50/1 w/Grommets and Sleeves |
| 293600511 | Call For Price | Compressor Painted EM48 220/50/1 w/Grommets and Sleeves |
| 293600512 | Call For Price | Compressor Painted EM24 230/60/3 w/Grommets and Sleeves |
| 293600513 | Call For Price | Compressor Painted EM30 230/60/1 w/Grommets and Sleeves |
| 293600514 | Call For Price | Compressor Painted EM36 230/60/3 w/Grommets and Sleeves |
| 293600515 | Call For Price | Compressor Painted EM48 230/60/3 w/Grommets and Sleeves |
| 293600516 | Call For Price | Compressor Painted EM24 380/50/3 w/Grommets and Sleeves |
| 293600517 | Call For Price | Compressor Painted EM30 380/50/3 w/Grommets and Sleeves |
| 293600518 | Call For Price | Compressor Painted EM36 380/50/3 w/Grommets and Sleeves |
| 293600519 | \$2,030.00 | Compressor Painted EM48 380/50/3 w/Grommets and Sleeves |
| 293600522 | Call For Price | Compressor Painted EM24 460/60/3 w/Grommets and Sleeves |
| 293600523 | Call For Price | Compressor Painted EM30 460/60/3 w/Grommets and Sleeves |
| 293600524 | Call For Price | Compressor Painted EM36 460/60/3 w/Grommets and Sleeves |
| 293600525 | \$1,980.00 | Compressor Painted EM48 460/60/3 w/Grommets and Sleeves |
| 298001125 | \$1,425.00 | Compressor Painted EM48 230/60/1 w/Grommets and Sleeves |

CONDENSERS

| <u>Part #</u> | <u>List Price (USD)</u> | <u>Description</u> |
|---------------|-------------------------|------------------------------------------------------------|
| 369627 | \$335.00 | Condenser Coil CS6/9 |
| 331235 | \$450.00 | Condenser Coil CS12/16 |
| 298001293 | Call For Price | Condenser Coil Painted CSD24RZ/1 |
| 332685 | \$265.00 | Condenser Coil Assembly, ECD/ECM 5K-HV, 115V |
| 334555 | \$295.00 | Condenser Coil Assembly, ECD/ECM 6.5K-HV, 115V |
| 335465 | \$355.00 | Condenser Coil Assembly, ECD/ECM 9-11K-HV, 115V |
| 335494 | \$390.00 | Condenser Coil Assembly, ECD/ECM 15K-HV, 115V |
| 293044246 | \$370.00 | Condenser Coil Assy w/90 degree elbows VC16K/1 (From 3/03) |
| 333344 | \$640.00 | Condenser Coil, 24M VC24 |

DX Replacement Parts Index

CONDENSERS Continued

| <u>Part #</u> | <u>List Price (USD)</u> | <u>Description</u> |
|---------------|-------------------------|--------------------------------------------------------------|
| 3062024 | \$740.00 | Condenser R-TYPE 20-24K |
| 701842482 | \$1,455.00 | Condenser RM42 R48 Heat Pump |
| 239401015 | \$340.00 | Condenser Coil Assy ST/ST6-8 W/EXT |
| 239401016 | \$380.00 | Condenser Coil Assy ST/ST10-12 W/EX |
| 239401017 | \$410.00 | Condenser Coil Assy ST/ST14-16 W/EX |
| 239401032 | \$300.00 | Condenser Coil Assy EM6-10K |
| 239401033 | \$430.00 | Condenser Coil Assy EM12-16K |
| 239401040 | \$615.00 | Condenser Coil Assy EM24K |
| 239401041 | \$955.00 | Condenser Coil Assy EM30K |
| 239401042 | \$1,300.00 | Condenser Coil Assy EM36K |
| 239401043 | \$1,380.00 | Condenser Coil Assy EM48K |
| 293044033 | \$335.00 | Condenser Coil Assy w/90 degree elbows SF7K |
| 293044034 | \$350.00 | Condenser Coil Assy w/90 degree elbows SF10K (Prior to 3/03) |
| 293044035 | \$400.00 | Condenser Coil Assy w/90 degree elbows SF12K (Prior to 3/03) |
| 293044036 | \$400.00 | Condenser Coil Assy w/90 degree elbows SF16K (Prior to 3/03) |
| R3600-S10 | \$635.00 | Condenser Stowaway Replacement SH/SX10 |
| R3600-S7 | \$500.00 | Condenser Stowaway Replacement SH/SX7 |

CONTACTORS

| | | |
|---------|----------|--------------------------------------------------|
| 334398 | \$125.00 | Contactors, 40A 3P 240V Emerald 24K-48K |
| 4130630 | \$235.00 | Contactors, 30A 3P 240V All R type units 24K-48K |
| 4130830 | \$245.00 | Contactors, 30A 3P 120V R24K-48K |
| 331551 | \$85.00 | Contactors, 40A 2P 240V Emerald 48K, 60K, RX48K |

CONTROLS AND CONTROL KITS

| | | |
|-----------|----------|--------------------------------------------------------------------|
| 223100502 | \$315.00 | Repl Board U-Control DX & TW |
| 223100500 | \$399.00 | Retro Module Passport I/O to Unity |
| 223100503 | \$615.00 | Repl Board U-Control-Network DX with Canbus *for replacements only |
| 263400645 | \$95.00 | Retrofit Kit Q/SMX Relay Board w/Hardware |
| 4120051 | \$36.00 | Replacement D-Relay Board for A-284 Retrofit Boxes 40A 115/230V |
| 701800012 | \$280.00 | Repl Control CKT 24VDC FR24NX |
| 224110090 | \$245.00 | 2-PRP circuit board & thermal compound packet |
| 224110091 | \$290.00 | 2-6 PRP circuit board & thermal compound packet |

Q-LOGIC BOXES AND BOARDS

| | | |
|-----------|------------|--------------------------------------------------------------------------|
| 701800004 | \$255.00 | Replacement Q-Logic Board |
| 763100061 | \$500.00 | Canbus adapter kit for Q-Logic, DX & TW (does not include Q-Logic board) |
| 222104002 | \$1,075.00 | Canbus to RS232 Serial Adapter Kit |

SMXii BOXES AND BOARDS

| | | |
|-----------|----------|--------------------------------------------------------------------------|
| 722300288 | \$355.00 | A-288D, Dual-Purpose Replacement SMXII HV Power Logic Board |
| 763100064 | \$770.00 | PLPX-HV, Replacement P/L Box 115/230V, (6-Pin Plug) |
| 763100037 | \$680.00 | PLHMX-HV, SMX II P/L Box for Modulating Systems, 115/230V |
| 701500104 | \$690.00 | A-279, SMX II Retrofit for F20C-F60C w/ HV Board (No Triac) |
| 705600011 | \$530.00 | Retro SMXII P/L Online > Net-U |
| 705600009 | \$430.00 | A-284, SMX II Retrofit P/L Box w/ HV Board A-288C (for 3-knob), 115/230V |

DX Replacement Parts Index

CONTROLS AND CONTROL KITS Continued

| <u>Part #</u> | <u>List Price (USD)</u> | <u>Description</u> |
|---------------------------------|-------------------------|---------------------------------------------------------------------------------------------|
| SMX NET BOXES AND BOARDS | | |
| 701500100 | Call For Price | NPLRX-2, Retrofit SX/FX Units to SMX NET, 115/230V, includes Aux Heat Triac as of 5/1/2003 |
| 701500103 | Call For Price | NPLRX-3, Retrofit WFAH/J/F Units to SMX NET, 115/230V, includes Aux Heat Triac as of 5/1/03 |
| 705600011 | \$530.00 | Replacement SMXII NET Board to U, 115/230V |
| 763100057 | \$395.00 | SMXLB, SMX Control Online Black |

DRAIN PAN

| | | |
|-----------|----------------|--------------------------------------------------------------------|
| 239300022 | \$160.00 | Drain Pan w/ Isolator Pads Turbo 6-8K |
| 239300023 | \$160.00 | Drain Pan w/ Isolator Pads Turbo 10-12K |
| 239300024 | \$160.00 | Drain Pan w/ Isolator Pads Turbo 14-16K |
| 239300027 | \$210.00 | Drain Pan SXUF18CK/1 Painted with Pad/Seal/Drain Kit/Top Comp Brkt |
| 239300038 | \$70.00 | Drain Pan w/ Isolator Pads TV4-8 |
| 239300039 | \$70.00 | Drain Pan w/ Isolator Pads TV10-12 |
| 239300040 | \$70.00 | Drain Pan w/ Isolator Pads TV16 |
| 291603723 | \$135.00 | Drain Pan Assembly CS6-16 |
| 291602794 | Call For Price | Drain Pan Assembly CS24-48 |
| 7000035 | \$80.00 | Kit Drain Pan Mounting VT6-16 |
| 291049008 | \$25.00 | Kit Drain Pan Mounting VC/SF 6-16 |
| 291049013 | \$25.00 | Kit Drain Pan Mounting VC24/SF24/VH24 |

DUCT & INSTALL KITS

| | | |
|-----------|----------------|--------------------------------------|
| 218000106 | \$1,105.00 | Install Kit 6K for ECD6K-HV |
| 218000110 | \$1,160.00 | Install Kit 10K for ECD10K-HV |
| 218000116 | \$1,240.00 | Install Kit 16K for ECD16K-HV |
| 218000117 | \$1,265.00 | Install Kit 16KZ for ECD16KZ/1-HV |
| 207500208 | Call For Price | Retrofit Kit for ECD6KZ50-HV R410A |
| 226600091 | \$155.00 | Dual Duct Kit 6K Enviro Units |
| 226600092 | \$155.00 | Dual Duct Kit 10K & 16K Enviro Units |

ELECTRICAL BOX ASSEMBLY

| <u>Part #</u> | <u>List Price (USD)</u> | <u>Description</u> |
|---------------|-------------------------|------------------------------------------------|
| 293049363 | Call For Price | Electrical Box Assy ECD/MCS12 2251 410A |
| 293049298 | \$470.00 | Electrical Box Assy ECD/MCS15 2251 417A |
| 293049297 | Call For Price | Electrical Box Assy ECD/MCS5 2251 417A |
| 293049289 | Call For Price | Electrical Box Assy ECD/MCS15 1161 417A |
| 293049381 | Call For Price | Electrical Box Assy ECD/MCS16 2361 417A Remote |
| 293049287 | Call For Price | Electrical Box Assy ECD/MCS9 1161 417A |

EVAPORATOR COIL ASSEMBLIES

| | | |
|--------|----------|--------------------------------------------------------------------------------------------------------------|
| 333279 | \$375.00 | Evaporator Coil E9FD (order strainer/cap 332342), SF10, VR/VH/VM 9, VC10, (Units built prior to March 2003) |
| 333281 | \$435.00 | Evaporator Coil E12FD (order strainer/cap 332341), VC12,16 SF12,16 (Built prior to March 2003) |
| 330028 | \$495.00 | Evaporator Coil E16FD Low Profile (filter strainer 332200) |

DX Replacement Parts Index

EVAPORATOR COIL ASSEMBLIES Continued

| <u>Part #</u> | <u>List Price (USD)</u> | <u>Description</u> |
|---------------|-------------------------|----------------------------------------------------------------------------|
| 335510 | Call For Price | Evaporator Coil SF10-1, VC10/1 (Units built from March 2003) |
| 335476 | \$370.00 | Evaporator Coil SF12-1 (Units built from March 2003) |
| 335898 | \$570.00 | Evaporator Coil 18M BTU SVCD18K 12X12 |
| 239401027 | Call For Price | Evaporator Coil Assy, Turbo 6K R410A w/ Strainer and Cap Tube |
| 239401028 | \$345.00 | Evaporator Coil Assy, Turbo 8K R410A w/ Strainer and Cap Tube |
| 239401029 | \$395.00 | Evaporator Coil Assy, Turbo 10K R410A w/ Strainer and Cap Tube |
| 239401030 | \$485.00 | Evaporator Coil Assy, Turbo 12K R410A w/ Strainer and Cap Tube |
| 239401031 | \$535.00 | Evaporator Coil Assy, Turbo 16K R410A w/ Strainer and Cap Tube |
| 239401009 | \$335.00 | Evaporator Coil Assy Turbo 6K w/ Strainer and Cap Tube |
| 239401010 | \$335.00 | Evaporator Coil Assy Turbo 8K w/ Strainer and Cap Tube |
| 239401011 | \$365.00 | Evaporator Coil Assy Turbo 10K w/ Strainer and Cap Tube |
| 239401012 | \$365.00 | Evaporator Coil Assy Turbo 12K w/ Strainer and Cap Tube |
| 239401014 | \$370.00 | Evaporator Coil Assy Turbo16K w/ Strainer and Cap Tube |
| 239401046 | \$755.00 | Evaporator Coil Assy, ET12FBM, CT, ST, CV w/ Strainer and Cab Tube |
| 239401019 | Call For Price | Evaporator Coil Assy, ECD/ECM 5K-HV, 115V |
| 239401020 | Call For Price | Evaporator Coil Assy, ECD/ECM 6.5K-HV, 115V |
| 239401021 | Call For Price | Evaporator Coil Assy, ECD/ECM 9K-HV, 115V |
| 239401022 | Call For Price | Evaporator Coil Assy, ECD/ECM 11K-HV, 115V |
| 239401023 | Call For Price | Evaporator Coil Assy, ECD/ECM 15K-HV, 115V |
| 239401036 | Call For Price | Evaporator Coil EBHE8 |
| 239401037 | Call For Price | Evaporator Coil EBHE10 |
| 332062 | \$245.00 | Evaporator Coil SF5, 5-1, 5-2, E4FD (order strainer/cap 335466) |
| 333278 | \$280.00 | Evaporator Coil SF7, VC7 & E6FD (order strainer/cap 332343) |
| 331890 | \$540.00 | Evaporator Coil SF24, VH24, E18-24FDZM (uses expansion valve 335013) |
| 293044121 | \$300.00 | Evaporator Coil Assy SF7 with filter strainer & cap tube |
| 293044123 | \$455.00 | Evaporator Coil Assy SF12 with filter strainer & cap tube (3/03 & earlier) |
| 293044124 | \$460.00 | Evaporator Coil Assy SF16 with filter strainer & cap tube (3/03 & earlier) |
| 715210513 | \$350.00 | Evaporator Coil Assy RE5/REU5 |
| 715210701 | \$395.00 | Evaporator Coil Assy RE7/REU7 |
| 715210801 | \$440.00 | Evaporator Coil Assy RE8/REU8 |
| 715211001 | \$440.00 | Evaporator Coil Assy RE10/REU10 |
| 715211201 | \$450.00 | Evaporator Coil Assy RE12/REU12 |
| 715211601 | \$615.00 | Evaporator Coil Assy RE16/REU16 |
| 715211629 | \$850.00 | Evaporator Coil Assy RE/REU36 |
| 715212419 | \$740.00 | Evaporator Coil Assy RE24/REU24 |

FILTER DRIERS

| | | |
|---------|---------|------------------------------------------------|
| 3150407 | \$75.00 | Drier, Filter R410A 2-6T BIFLO Emerald 24K-48K |
| 3150409 | \$55.00 | Drier, Filter R410A Emerald 6K-16K |

FUSES

| | | |
|---------|---------|----------------------------------------------------------------------------|
| 335498 | \$8.57 | Fuse 3AG .8 AMP SMX PC Board |
| 4122810 | \$7.50 | Fuse MDA Ceramic 10A PR3X, PR8X |
| 334397 | \$18.00 | Fuse 1/4AMP 250V (automotive type), A-281C SMX II Board w/ Heat Sink Plate |
| 4122891 | \$19.00 | Fuse 50mA 5X20mm Delay 250V, A-281C SMX II Board wo/ Heat Sink Plate |

DX Replacement Parts Index

HEATERS

| <u>Part #</u> | <u>List Price (USD)</u> | <u>Description</u> |
|---------------|-------------------------|---------------------------------------------------|
| 4200700 | \$110.00 | Heater Rect. 1KW 240V 25FIN EBHE6-8K |
| 4200800 | \$110.00 | Heater Rect. 1.5KW 240V 25FIN EBHE10K |
| 4200801 | \$105.00 | Heater Rect. 1.5KW 240V 25FIN 3Element EBHE24-30K |
| 4200900 | \$110.00 | Heater Rect. 2KW 240V 25FIN EBHE12K |
| 4200901 | \$110.00 | Heater Rect. 2KW 240V 25FIN 3Element EBHE16K |

OVERLOADS

| | | |
|------------|----------|------------------------------------------------------------------|
| 044700 | \$34.00 | Overload Old Copeland 30101-16 |
| 046801 | \$32.00 | Overload Tecumseh 3014112 (SHR,SXR12,16) |
| 046805 | \$29.00 | Overload Tecumseh 3014212 (SHR,SXR12CK) |
| 048900 | \$32.00 | Overload Tecumseh 30101-10 * (SH, SX10) / (R10) 115V |
| 049000 | \$31.00 | Overload Tecumseh 30101-11 &12 (SH, SX12) / (R12) 115V |
| 049200 | \$36.00 | Overload Tecumseh 30102-10 * (SH, SX10C) / (R10C) 230V |
| 049300 | \$32.00 | Overload Tecumseh 30102-12 * (SH, SX12C) / (R12C) 230V |
| 330924 | \$36.00 | Overload Therm 140° Auto Reset |
| 331404 | \$31.00 | Overload 16K 115V/AK8515 (SH,SX16, R16) |
| 331405 | \$30.00 | Overload 16K 220V/AKA8515EXD |
| 331406 | \$31.00 | Overload 6K 115V/AE5465E (SH,SX7) |
| 331407 | \$31.00 | Overload 6K 220V/AE5465E |
| 332849 | \$29.00 | Overload 7K 115V RG5467E |
| 332850 | \$31.00 | Overload 230V SF7C |
| 332852 | \$29.00 | Overload 9/10 115 RK5480E |
| 332855 | \$29.00 | Overload 12K 115V RK5510E (SHR,SXR12 & SF12 built thru Feb. '03) |
| 332858 | \$27.00 | Overload 16K 115V RK5513E (SHR,SXR16, SF16) |
| 332859 | \$29.00 | Overload 16K 220V RK5515E (SF16C, Turbo 16K 220V) |
| 332860 | \$29.00 | Overload 220V SF16CK |
| 3100250.28 | \$13.00 | Overload 115V VC16K / VR16K |
| 335571 | \$29.00 | Overload 115V SF10-1 (built from Mar. '03) |
| 335573 | \$29.00 | Overload MRA-38126-113..30299 |
| 335574 | \$28.00 | Overload 115V SF12-1 (built from Mar. '03) |
| 335575 | \$29.00 | Overload 220V SF12CK-1 (built from Mar. '03) |
| 336569 | \$200.00 | Overload .62-1.1A W/40A-CONTR |
| 334570 | \$195.00 | Overload*1.3-1.9A |
| 334173 | \$195.00 | Overload*1.8-2.7A |
| 336573 | \$80.00 | Overload, 2.5-4A use with 40 Amp Contactor |
| 334171 | \$195.00 | Overload*5.5-8.5 |
| 334172 | \$195.00 | Overload*8-12A |
| 336577 | \$200.00 | Overload, 12-18A use with 40 Amp Contactor |

DX Replacement Parts Index

OVERLOADS Continued

| Part # | List Price (USD) | Description |
|---------|------------------|-------------------------------------------------------------------------------|
| 4043100 | \$22.00 | Overload 5K 115V MRA99087-325 |
| 4062800 | \$43.00 | Overload Therm 180° Manual Reset |
| 4120007 | \$22.00 | Overload MRA-12370-117..30299 R417A 115V Turbo 12K, VC12K/2, VR12K/2, SXF12/2 |
| 4120008 | \$22.00 | Overload MRA98866-325 7K-115V |
| 4120009 | \$22.00 | Overload MRA98856 7K-230V |
| 4120010 | \$22.00 | Overload MRA99027 10/12K-230V |
| 4120022 | \$22.00 | Overload MRA98768 16K-230V |
| 4120023 | \$26.00 | Overload MRA98704 18K-240V/50 |
| 4120024 | \$22.00 | Overload MRA99017-325 5K 240/50 |
| 4120025 | \$22.00 | Overload MRA99137-325 7K 240/50 |
| 4120027 | \$22.00 | Overload MRB5812-807 16K 115V |
| 4120028 | \$22.00 | Overload MRA99200-325 10K 240 |
| 4120038 | \$22.00 | Overload MRA98706-325 10K |
| 4120039 | \$22.00 | Overload MRA99052-325 10KZ |
| 4120040 | \$22.00 | Overload MRA98533-325 14Z-Z50 |
| 4120046 | \$20.00 | Overload MRA-12371-729..30299 |
| 4120047 | \$20.00 | Overload MRA-12372-729..30299 |
| 4120057 | \$29.00 | Overload TECUMSEH 8300MSTH34 |
| 4120060 | \$42.00 | Overload TECUMSEH 8300MSPT89 |
| 4120061 | \$31.00 | Overload TECUMSEH 8300MRAT71 |
| 4120062 | \$21.00 | Overload TECUMSEH 8300MSTT72 |

PRESSURE SWITCHES/TEE ASSY

| | | |
|-----------|----------|----------------------------------------------------------------|
| 4024214 | \$39.00 | Control HPS 575PSI R410A 1/4"F all Turbo R410A Digital |
| 4024217 | \$41.00 | Control LPS CO60 CI90 1/4"F FL Emeralds R410A 6-16K Mechanical |
| 4024218 | \$41.00 | Control HPS CO575 CI400 1/4"FF all Turbo R410A Mechanical |
| 4024219 | \$41.00 | Control LPS 60-75 +/-5 Emeralds R410A 6-16K Digital |
| 4024221 | \$46.00 | Control HPS 400/300 R407C (450psi) |
| 4024222 | \$46.00 | Control LPS 78-92 1/4FL 1/4QD (78psi) R410A |
| 4024200 | \$35.00 | Control LPS CO27 CI45 (UL) R417A, R407C (27psi) |
| 4024300 | \$41.00 | Control HI PSI CO425 CI325(UL) all Turbo R417A Digital |
| 4024400 | \$42.00 | Control HI PSI CO425 CI275 all Turbo R417A Mechanical |
| 297000050 | \$85.00 | A-200, Line Duty High Pressure Switch, R417A/R22 |
| 297000047 | \$85.00 | A-201, Low Pressure Switch, R417A/R22 |
| 297000054 | \$80.00 | A-204, Low Pressure Port Retro Kit, R417A/R22 |
| 297000048 | \$85.00 | A-205, High Pressure Switch, R417A/R22 |
| 297000012 | \$140.00 | Tee Assembly High Pressure, high amperage, R417A/R22 |
| 297000013 | \$155.00 | Tee Assembly Low Pressure, high amperage, R417A/R22 |
| 297000014 | \$135.00 | Tee Assembly High Pressure, low amperage |
| 297000015 | \$155.00 | Tee Assembly Low Pressure, low amperage |

Notes:

1. Does not require cutting into refrigeration circuit.
2. Includes port for continued easy serviceability.

DX Replacement Parts Index

RECEIVER FOR EMERALDS AND CS REMOTES

| Part # | List Price (USD) | Description |
|---------------|-------------------------|--------------------------------------------------|
| 331170 | \$155.00 | Receiver, Bi-Flow CS6K - CS36K & Emeralds 24-36K |
| 3150401 | \$290.00 | Receiver, Bi-Flow Emeralds 48K all voltages |

RELAYS

| | | |
|-----------|----------|--------------------------------------------------------------------------------------------------------------------------------------|
| 331269 | \$70.00 | Relay Potential JPR 65 |
| 331721 | \$155.00 | Relay Start GE 3ARR22W24 |
| 332056 | \$46.00 | Relay 24V Coil 10A SPST one per stage, smallest Relay Start Motor UMSR50 replaces p/n's 334166, 332695, 4136150, 4037074, 332695, |
| 4040060 | \$70.00 | 4040054, 4037071, 4130150, 4128325, 4130100, 4130200 |
| 4128010 | \$160.00 | Relay Potential JPR 66 |
| 4134200 | \$255.00 | Relay Solid State 75 amp |
| 4134902 | \$80.00 | Relay DPDT 230V 30 Amp |
| 4136050 | \$110.00 | Relay Ign Protected 4136000 |
| 4220047 | \$90.00 | Relay PC Board A-550 |
| 298001141 | \$145.00 | Relay Start Ign Protected (R48CK) |
| 298001157 | \$120.00 | Relay Start Ign Protected (R30CK) |
| 298001216 | \$205.00 | Relay Start Ign Protected GE3ARR3T1 (R20/36CK) |
| 298600007 | \$170.00 | Relay Ign Protected 4136300 (R24CK) |
| TR115 | \$70.00 | Relay Trigger 115V |
| TR230 | \$70.00 | Relay Trigger 230V |

RESISTOR

| | | |
|---------|----------------|-----------------------------------------------|
| 4143515 | Call For Price | Resistor 15K OHM 2 Watt |
| 4143775 | Call For Price | Resistor 7.5K OHM 10W all RM units |
| 4146400 | \$1.16 | Resistor 56K OHM 2 Watt |
| 332516 | Call For Price | Resistor 62K OHM 1 Watt for DDC circuit board |

REVERSING VALVES

| | | |
|-----------|----------|-----------------------------------------------------------------------|
| 3081601 | \$55.00 | Reversing Valve Assy Emeralds 6K-10K all voltages |
| 3081409 | \$55.00 | Reversing Valve Assy Emeralds 12-16K all voltages, VCD18-27K |
| 3081511 | \$55.00 | Reversing Valve Assy Emeralds 24K-36K all voltages |
| 3081520 | \$110.00 | Reversing Valve Assy Emeralds 48K all voltages |
| 239100071 | \$265.00 | Reversing Valve Assy Turbo 6-8K 115V w/Solenoid |
| 239100072 | \$265.00 | Reversing Valve Assy Turbo 6-8K 220/230V w/Solenoid |
| 239100073 | \$280.00 | Reversing Valve Assy Turbo 10-12K 115V w/Solenoid |
| 239100074 | \$280.00 | Reversing Valve Assy Turbo 10-12K 220/230V w/Solenoid |
| 239100075 | \$295.00 | Reversing Valve Assy Turbo 14-16K 115V w/Solenoid |
| 239100076 | \$295.00 | Reversing Valve Assy Turbo 14-16K 220/230V w/Solenoid |
| 239100080 | \$225.00 | Reversing Valve Assy Stowaway SXF & SHF 12-16 (after 3/03) w/Solenoid |

DX Replacement Parts Index

REVERSING VALVES Continued

| Part # | List Price (USD) | Description |
|---------------|-------------------------|----------------------------------------|
| 701820245 | \$500.00 | Reversing Valve Assy A-509B SH/SX/R7 |
| 701820243 | \$500.00 | Reversing Valve Assy A-509C R10-16 |
| 701820242 | \$500.00 | Reversing Valve Assy A-511B SH/SX10-16 |
| 701820240 | \$500.00 | Reversing Valve Assy R20/24 |
| 701830360 | \$500.00 | Reversing Valve Assy R30/36 |
| 701820246 | \$500.00 | Reversing Valve Assy R48 Straight Tube |

SOLENOID COIL

| | | |
|---------|---------|----------------------------------------------------------------------------|
| 4071402 | \$20.00 | Coil, Solenoid 24V LDK11 48" |
| 4071501 | \$23.00 | Coil, Solenoid 115V SH/SX7 / SHR/SXR7 / R5 / R7 |
| 4071502 | \$20.00 | Coil, Solenoid 115V LDK-310000 SH/SX10-16 / SHR/SXR10-16 / R10-16 |
| 4071503 | \$18.00 | Coil, Solenoid 115V LDL-31-120 Turbo 6-16K |
| 4071601 | \$23.00 | Coil, Solenoid 230V SH/SX7C / R7C / R7CK |
| 4071602 | \$20.00 | Coil, Solenoid 230V LDK-410000 SH/SH10-24, R10-16, VCD18K & 27K |
| 4071603 | \$18.00 | Coil, Solenoid 230V LDL-41-120 All R410A Turbo - 6k - 16k & R417A 6K - 16K |

START ASSIST

| | | |
|--------|---------|---------------------------------------|
| 335055 | \$13.00 | Start Assist. 370HM PTCR Emerlads 16K |
|--------|---------|---------------------------------------|

STRAINER WITH CAP TUBE

| | | |
|---------|----------------|------------------------------------|
| 335466 | \$29.00 | Strainer with cap tube SF5K |
| 332343 | \$33.00 | Strainer with cap tube SF7K |
| 332342 | Call For Price | Strainer with cap tube SF10K |
| 332341 | \$44.00 | Strainer with cap tube SF12K |
| 332340 | \$44.00 | Strainer with cap tube SF16K |
| 3150018 | \$49.00 | Strainer with cap tube SF18K, 410A |

TX VALVE

| | | |
|---------|----------|------------------------------------------------------------------------------------|
| 3084704 | \$200.00 | Valve, TXV R410A w/Internal Check Valve for Emerald 6K-16K |
| 3080058 | \$190.00 | Valve, TXV R410A 2T w/Internal Check Valve for Emerald 24-30K & R410A Evaps 18-30K |
| 3080059 | \$210.00 | Valve, TXV R410A 3T w/Internal Check Valve for Emerald & R410A Evaps 36-48K |
| 3080060 | \$220.00 | Valve, TXV R410A 5T w/Internal Check Valve for Emerald & R410A Evaps 60-72K |

CHILLED WATER REPLACEMENT PARTS

AU Airhandler Parts Breakdown

PROPRIETARY NOTE: THE INFORMATION CONTAINED WITHIN THIS DOCUMENT IS THE PROPERTY OF DOMETIC CORPORATION. ANY ATTEMPT TO COPY OR DISTRIBUTE THIS DOCUMENT WITHOUT THE WRITTEN CONSENT OF DOMETIC CORPORATION SHALL BE CONSIDERED UNLAWFUL AND CAN BE CONTESTED IN A COURT OF LAW.



| REV | DATE | REVISION DESCRIPTION | DWG | APR | DOMETIC |
|-----|------|----------------------|-----|-----|--------------------------------------------------|
| | | | | | TITLE: AU REPLACEMENT PARTS |
| | | | | | DATE: 10/30/15 DWG BY: DRR PART NUMBER: D3020000 |
| | | | | | SCALE: 1:16 APR BY: O.I. |

AU/AU-EU Replacement Parts Table

| AU/AU-EU HVZ Capacity | Voltage | Blower | Coil *Raw | Capacitor | Mount Ring | Flow Regulator | Breathe Easy Bulb |
|----------------------------------|----------------|---------------|------------------|------------------|-----------------------|---------------------------|------------------------------|
| 6K | 230V | 264400087 | 336081 | 4040004 | 335884 | 293600556 | 4210800 |
| 9K | 230V | 264400083 | 336082 | 4040003 | 335883 | 293600298 | 4210800 |
| 12K | 230V | 264400084 | 336082 | 4040047 | 335883 | 293600299 | 4210800 |
| 18K | 230V | 264400085 | 336084 | 4040046 | 335882 | 293600301 | 4210827 |
| 24K | 230V | 264400081 | 336085 | 4040008 | 228701034 | 293600302 | 4210827 |

| AU/AU-EU DCZ Capacity | Voltage | Blower | Coil *Raw | Capacitor | Mount Ring | Flow Regulator | Breathe Easy Bulb |
|----------------------------------|----------------|---------------|------------------|------------------|-----------------------|---------------------------|------------------------------|
| 6K | 230V | 264400135 | 336081 | N/A | 335884 | 293600556 | 4210800 |
| 9K | 230V | 264400136 | 336082 | N/A | 335883 | 293600298 | 4210800 |
| 12K | 230V | 264400091 | 336082 | N/A | 335883 | 293600299 | 4210800 |
| 18K | 230V | 264400090 | 336084 | N/A | 335882 | 293600301 | 4210827 |
| 24K | 230V | 264400137 | 336085 | N/A | 228701034 | 293600302 | 4210827 |

*For coil assembly please call for part number and price.

AU/AU-EU Air handlers - All Capacities and Voltages where applicable

| Capacity | Valve 3 Way | 1KW Heater | 1.5KW Heater | High Limit Overload | Low Limit Overload | UV Light |
|-----------------|------------------------|-------------------|-------------------------|--------------------------------|-------------------------------|-----------------|
| 6K - 24K | 4070008 | 4200701 | 4200801 | 4210034 | 330924 | 4210833 |

CHILLED WATER REPLACEMENT PARTS

ATL Airhandler Parts Breakdown

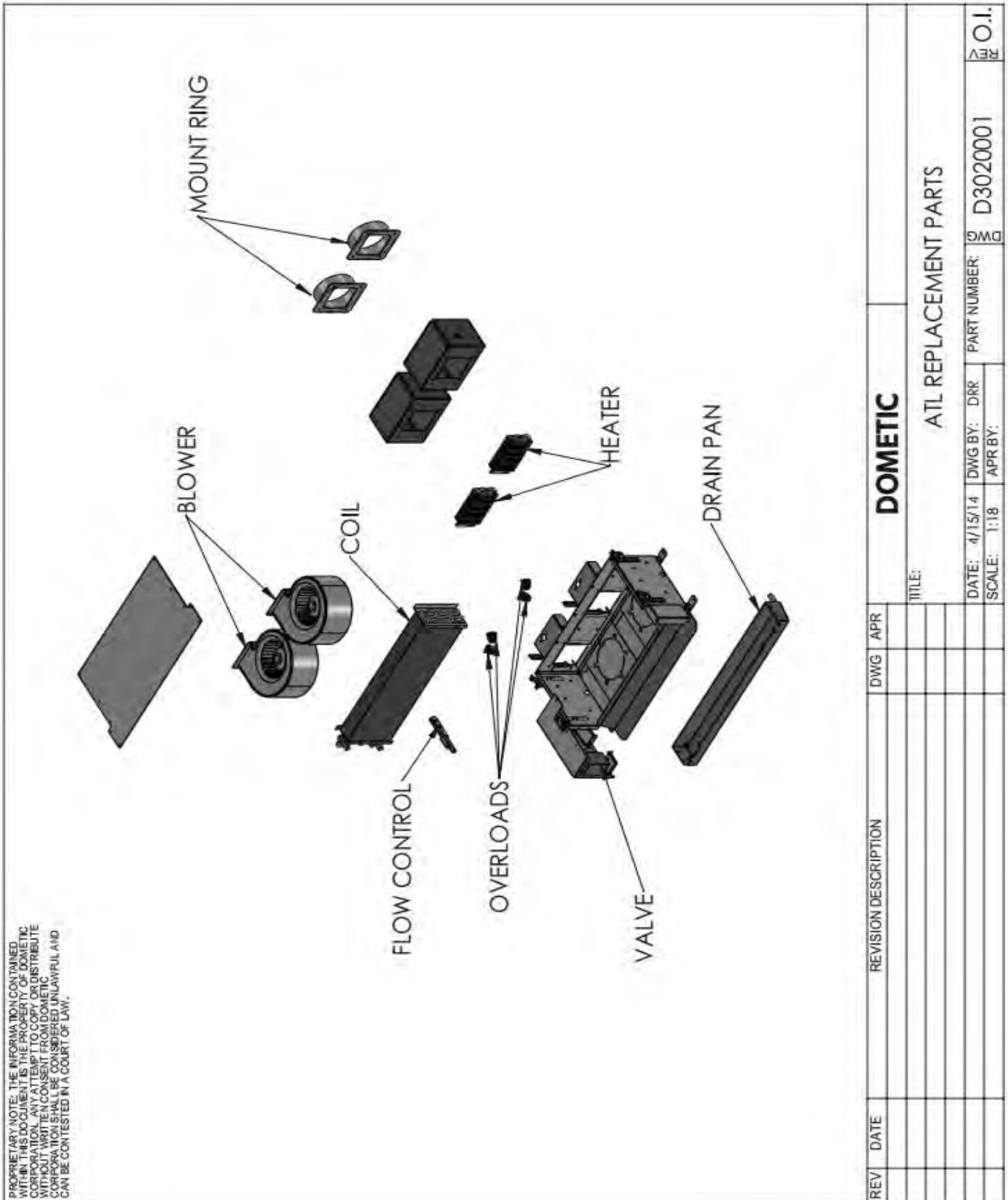

ATL Replacement Parts Table

ATL HVZ

| Capacity | Voltage | Blower | Capacitor | Coil | Mount Ring | Flow Control |
|----------|---------|---------|-----------|---------|------------|--------------|
| 6K | 230V | 2054304 | 4040004 | 3020059 | 335883 | 334943 |
| 9K | 230V | 2054302 | 4040003 | 3020059 | 335883 | 339435 |
| 12K | 230V | 2054302 | 4040003 | 3020058 | 335883 | 334945 |
| 18K | 230V | 2054302 | 4040003 | 3020058 | 335883 | 334947 |
| 24K | 230V | 2054310 | 4040008 | 360220 | 228701034 | 334368 |
| 36K | 230V | 2054318 | 4040046 | 330898 | 228701034 | 334309 |

ATL DCZ

| Capacity | Voltage | Blower | Capacitor | Coil | Mount Ring | Flow Control |
|----------|---------|---------|-----------|---------|------------|--------------|
| 6K | 230V | 2011024 | N/A | 3020059 | 335883 | 334943 |
| 9K | 230V | 2011024 | N/A | 3020059 | 335883 | 339435 |
| 12K | 230V | 2011024 | N/A | 3020058 | 335883 | 334945 |
| 18K | 230V | 2011024 | N/A | 3020058 | 335883 | 334947 |
| 24K | 230V | 336688 | N/A | 360220 | 228701034 | 334368 |
| 36K | 230V | 336688 | N/A | 330898 | 228701034 | 334309 |

| | Voltage | 3-Way Valve | High Limit Switch | Low Limit Switch | UV Ballast | Heater 1KW | Heater 1.5KW |
|----------------|---------|-------------|-------------------|------------------|------------|------------|--------------|
| All Capacities | 230V | 4070008 | 4210034 | 330924 | 4210833 | 4200701 | 4200801 |

| Item | List Price USD | Description | Item | List Price USD | Description |
|---------|----------------|---------------------|-----------|----------------|--------------------------|
| 330898 | \$2,035.00 | Coil 36K | 2054310 | \$410.00 | Blower 24K HVZ |
| 330924 | \$36.00 | Low Limit Switch | 2054318 | \$450.00 | Blower 36K HVZ |
| 336688 | \$1,345.00 | Blower 24-36K DCZ | 3020058 | Call For Price | Coil 12-18K |
| 360220 | \$1,060.00 | Coil 24K | 3020059 | \$585.00 | Coil 6-9K |
| 334309 | \$250.00 | Flow Control 36K | 4040003 | \$9.12 | Capacitor 9-18K HVZ |
| 334368 | \$250.00 | Flow Control 24K | 4040004 | \$9.65 | Capacitor 6K HVZ |
| 334935 | \$250.00 | Flow Control 9K | 4040008 | \$15.00 | Capacitor 24K HVZ |
| 334943 | \$250.00 | Flow Control 6K | 4070008 | \$250.00 | 3-Way Valve 230V |
| 334945 | \$250.00 | Flow Control 12K | 4120034 | \$50.00 | High Limit Switch |
| 334947 | \$250.00 | Flow Control 18K | 4200701 | \$95.00 | Heater 1KW 240V 17-FIN |
| 335883 | \$20.00 | Mount Ring 6-18K | 4200801 | \$105.00 | Heater 1.5KW 240V 25-FIN |
| 2011024 | \$1,235.00 | Blower 6-18K DCZ | 4210833 | \$110.00 | UV Ballast |
| 2054302 | \$235.00 | Blower 9K & 18K HVZ | 228701034 | \$42.00 | Mount Ring 24-36K |
| 2054304 | \$180.00 | Blower 6K & 12K HVZ | | | |

Chilled Water Replacement Parts Index

ADAPTER

| <u>Part #</u> | <u>List Price (USD)</u> | <u>Description</u> |
|---------------|-------------------------|------------------------------------|
| 334275 | \$15.00 | Adapter, SW Manifold, 5/8 x 1/2MPT |

AIR HANDLER PARTS

| | | |
|-----------|----------------|---------------------------------------------------------------------------------------|
| 264400065 | \$435.00 | Retrofit Kit Breathe Easy AU6-12 |
| 264400066 | \$455.00 | Retrofit Kit Breathe Easy AU18-24 |
| 335168 | \$130.00 | Actuator only, Erie "Pop-Top"™, 115V |
| 335169 | \$145.00 | Actuator only, Erie "Pop-Top"™, 230V |
| 333837 | \$335.00 | 3-way valve & actuator, 115V, 3/4" IFL, Erie "Pop-Top"™ |
| 333839 | \$325.00 | 3-way valve & actuator, 230V, 3/4" IFL, Erie "Pop-Top"™ |
| 4070007 | \$250.00 | 3-way valve & actuator, 115V, 1/2" sweat, replaces: Erie "Pop-Top"™ & Sinro (Plastic) |
| 4070008 | \$250.00 | 3-way valve & actuator, 230V, 1/2" sweat, replaces: Erie "Pop-Top"™ & Sinro (Plastic) |
| 335808 | \$510.00 | 3-way valve & actuator, 230V, 1" sweat, Erie "Pop-Top"™ |
| 332063 | \$130.00 | Motor Only for 3-way valve, 115V (see note) |
| 332002 | \$135.00 | Motor Only for 3-way valve, 230V (see note) |
| 291613004 | \$65.00 | 36" Water Bleeder Valve Asy w/Nylon Tube & Straight Fitting |
| 291613033 | \$75.00 | 40" Water Bleeder Valve Asy w/Nylon Tube & Elbow Fitting |
| 297000043 | \$90.00 | COS, Changeover T-STAT with Spring |
| 334084 | Call For Price | SPRING, to hold COS |

Notes:

1. Sinro valves and replacement parts are no longer available. The motors listed above CAN be used on Sinro AND Erie valves. If the motor alone will not suffice, then replace a Sinro valve with the appropriate voltage of the SWEAT Erie valve. DO NOT attempt to replace a Sinro with an IFL Erie valve. Refer to 2009 Field Notice 294-K09 for more information.
2. Actuator Note: Erie IFL and sweat valves use the same Erie actuator.
3. Sizing Note: 1/2" sweat valves fit 5/8" od copper tubing. 3/4" IFL (internal flare) valves fit flared 5/8" od copper tubing. 1" sweat tube. fits 1-1/8" od copper
4. Erie/Invensys/TAC Note: Erie, Invensys, and TAC are different names for the same valve manufacturer and same valves.
5. Motor Only Note: "Motor Only" part numbers require the actuator to be opened and the motor itself replaced. This is not an easy operation, especially if the air handler is installed. We recommend replacing the entire actuator instead.
EXCEPTION: If you have a Sinro valve, it is easier to replace the motor than to replace the entire valve. Air handlers built before 2000 may not have removable actuators. In that case, replacing the motor may be preferable to replacing the entire valve.

AUXILLIARY HEATERS REPLACEMENT PARTS

| <u>Part #</u> | <u>List Price (USD)</u> | <u>Description</u> |
|---------------|-------------------------|---------------------------------------------------------------------------------|
| 4201200 | \$110.00 | Heat Element for AT's, rectangular, 1KW, 120V |
| 4200700 | \$110.00 | Heat Element for AT's, rectangular, 1KW, 240V |
| 4201100 | \$110.00 | Heat Element for AT's, rectangular, 1 5KW, 120V |
| 4200800 | \$110.00 | Heat Element for AT's, rectangular, 1 5KW, 240V |
| 4201000 | \$110.00 | Heat Element for AT's, rectangular, 2KW, 120V |
| 4200900 | \$110.00 | Heat Element for AT's, rectangular, 2KW, 240V |
| 335871 | \$47.00 | Overload Thermal, Man-reset, 160F (Slimlines) |
| 4120034 | \$50.00 | Overload Thermal, Man-reset, 240F (AT, ABL, ATL, ATV) |
| 330924 | \$36.00 | Overload Thermal, Auto-reset, 140F (PHD & all CW AHs, including FAMU's) |
| 331002 | \$21.00 | Thermal Fuse, 98C, 1KW and smaller (PHD, AHDT, AHFD, Slimlines, Blowthroughs) |
| 331044 | \$21.00 | Thermal Fuse, 152C, 1.5KW and larger (PHD, AHDT, AHFD, Slimlines, Blowthroughs) |
| 331035 | \$610.00 | HTELM1.5KWZ, Heat Element, 1 5KW, 230V |

Chilled Water Replacement Parts Index

BLOWERS

Blowers AU-HVZ

| <u>Part #</u> | <u>List Price (USD)</u> | <u>Description</u> |
|---------------|-------------------------|------------------------------|
| 264400087 | \$370.00 | REPL BLWR AU6HVZ 5"MR W/CAP |
| 264400083 | \$390.00 | REPL BLWR AU9HVZ 6"MR W/CAP |
| 264400084 | \$440.00 | REPL BLWR AU12HVZ 6"MR W/CAP |
| 264400085 | \$480.00 | REPL BLWR AU18HVZ 7"MR W/CAP |
| 264400081 | \$720.00 | REPL BLWR AU24HVZ 8"MR W/CAP |

Blowers AU-DCZ

| | | |
|-----------|------------|-----------------------------|
| 264400135 | \$1,365.00 | REPL BLWR AU6DCZ 5"MR 230V |
| 264400136 | \$1,395.00 | REPL BLWR AU9DCZ 6"MR 230V |
| 264400091 | \$1,490.00 | REPL BLWR AU12DCZ 6"MR 230V |
| 264400090 | \$1,490.00 | REPL BLWR AU18DCZ 7"MR 230V |
| 264400137 | \$1,620.00 | REPL BLWR AU24DCZ 8"MR 230V |

Blowers AH & AT-HV

| | | |
|-----------|------------|-------------------------------------------|
| 264400008 | \$370.00 | REPL BLWR AT4FZ 4"MR 230V |
| 264400078 | \$245.00 | REPL BLWR AT4HVZ W/CAP 4"MR 230V |
| 264400127 | \$410.00 | REPL BLWR AT9HVZ 6"MR W/CAP 230V |
| 264400128 | \$430.00 | REPL BLWR AT12HV/ABL24HVZ 6"MR 230V |
| 264400129 | \$500.00 | REPL BLWR AT18HVZ 7"MR W/CAP 230V |
| 264400053 | \$645.00 | REPL BLWR AT24HVZ 8"MR W/CAP 230V |
| 264400006 | \$775.00 | REPL BLWR AT36HVZ 8"MR W/CAP 230V |
| 291617076 | \$535.00 | BLWR INS AH6DT2, AT6HV W/CAP, 115V |
| 291617010 | \$645.00 | BLWR INS AH9DT2, AT9HV W/CAP, 115V |
| 291617077 | \$700.00 | BLWR INS AH12DT2, VH16HV, AT12HV, 115V |
| 291617078 | \$850.00 | BLWR INS AH16-18DT2, AT18HV W/CAP, 115V |
| 293042093 | \$1,365.00 | BLWR INS AH24DT(Z)/FD(Z) 8MR, 115V/230V |
| 291617014 | \$505.00 | BLWR INS AH6DT2Z, AT6HVZ W/CAP, 230V |
| 291617011 | \$645.00 | BLWR INS AH9DT2Z, AT9HVZ W/CAP, 230V |
| 291617006 | \$695.00 | BLWR INS AH12DT2Z W/CAP, 230V |
| 291617079 | \$850.00 | BLWR INS AH16-18DT2Z W/CAP, 230V |
| 293042101 | \$720.00 | BLWR INS AH24DTZ/FDZ TO HVZ 8"MR, 230V |
| 293042086 | \$450.00 | BLWR INS AH4FDZ 4"MR, 230V |
| 291617001 | \$620.00 | BLWR INS 16-18, FDHVZ, DT2Z HV W/CAP 230V |
| 264400080 | \$1,185.00 | BLWR AH12-24BTZ W/PLT, 230V |

Note: Includes insulated blower, inlet mounting ring, and capacitor. Duct ring not included.

Blowers AT-DC

| | | |
|-----------|------------|-------------------------------------|
| 264400021 | \$1,285.00 | REPL BLWR AT6DC 5"MR 230V |
| 264400020 | \$1,290.00 | REPL BLWR AT9DC 6"MR 230V |
| 264400019 | \$1,415.00 | REPL BLWR AT12DC/ABL24DCZ 6"MR 230V |
| 264400018 | \$1,395.00 | REPL BLWR AT18DC 7"MR 230V |
| 264400017 | \$1,495.00 | REPL BLWR AT24DCZ 8"MR 230V |
| 264400016 | \$1,710.00 | REPL BLWR AT36DCZ 8"MR 230V |

Chilled Water Replacement Parts Index

BLOWERS Continued

Blowers ATL-DC

| Part # | List Price (USD) | Description |
|---------|------------------|------------------------------------------------------------------|
| 2011024 | \$1,235.00 | REPL BLWR, ATL6-18K DCZ 230/50-60/1 (2 per unit for 12K and 18K) |
| 336688 | \$1,345.00 | REPL BLWR, ATL24-36K DC-E 230/50-60/1 (2 per unit for 36K) |

Blowers ATL-HV

Note: Refer to ATL Replacement Parts Table on previous page for ATL 230V blowers.

| | | |
|---------|----------|----------------------------------------------------------------|
| 2054316 | \$220.00 | Replacement Blower ATL6K & ATL12K HV 115V (2 per unit for 12K) |
| 2054306 | \$225.00 | Replacement Blower ATL9K & ATL18K HV 115V (2 per unit for 18K) |
| 2011001 | \$280.00 | Replacement Blower ATL24-36K HV 115V (2 per unit) |

CAPACITOR - BLOWER

| | | |
|---------|---------|-------------------------------------------------------------|
| 4040003 | \$9.12 | 3 mfd with spades for 9K HVZ 230V - AT, ATL, ABL18, AU |
| 4040004 | \$9.65 | 4 mfd with spades for AT6,12,18,24HVZ 230V |
| 4040047 | \$14.00 | 5 mfd with spades for 12K HVZ 230V - AT, ATV, ABL24, AU |
| 4040046 | \$14.00 | 6 mfd with spades for 18K-24K HVZ 230V AT, ATL36, ATV, AU |
| 2053101 | \$21.00 | 6 mfd, high velocity blower capacitor w/o spades |
| 4040008 | \$15.00 | 8 mfd with spades for 24K & 36K HVZ 230V - AT, ATL, ATV, AU |
| 4040006 | \$18.00 | 10 mfd with spades for 9K & 12K HV 115V - AT, ATL, ATV, AU |
| 4040005 | \$17.00 | 16 mfd with spades for 6K & 12K HV 115V - AT, ATV, AU |
| 4040014 | \$17.00 | 20 mfd with spades for 18K-24K 115V HV - AT, ATL, AU |
| 331103 | \$18.00 | CAP2MFD, 2 mfd Fan Run Capacitor |
| 333345 | \$9.46 | CAP5MFD, 5 mfd Fan Run Capacitor |
| 331027 | \$24.00 | CAP20MFD, 20 mfd Fan Run Capacitor |

CONTACTOR

| | | |
|--------|----------|----------------------------------------|
| 332169 | \$245.00 | Contactors AEG, 40A 3 phase, 240V coil |
| 336556 | \$100.00 | Contactors, 40A 3P 240V CWMC, TWLC |
| 336557 | \$125.00 | Contactors, 40A 3P 24V COIL |

CONTROLS AND CONTROL KITS

| | | |
|-----------|------------|-------------------------------------------------------------------------|
| 4220002 | \$620.00 | DDC circuit board, new dual voltage 115/230V (replaces 333647 & 333576) |
| 4220102 | \$625.00 | Control, DDC 2-Speed 115/230V |
| 263401101 | \$780.00 | Replacement TWLC Control Board-Rev B |
| 4240500 | \$130.00 | DC Converter Board |
| 4250042 | \$385.00 | Canbus Adapter Board for Q-Logic Networks |
| 263600170 | \$680.00 | Control Replacement Kit CWMC with new rev H board and mounting plate |
| 4220003 | \$630.00 | Control, CWMC new rev H (this replaces part number 334618) |
| 4220103 | \$630.00 | Control, CWMC 2-Speed |
| 291880000 | \$2,200.00 | Hydromatic Circuit Board, 3-5S, RC,230V |
| 291880195 | \$2,115.00 | Hydromatic Circuit Board, 3-5S, CL, 230V |
| 763300034 | \$26.00 | Replacement EPROM for MPE board |

CURRENT TRANSDUCERS (used on PLC Chiller Controls)

| | | |
|--------|----------|---------------------------|
| 337468 | \$195.00 | 10 amp Current Transducer |
| 337469 | \$195.00 | 30 amp Current Transducer |
| 337470 | \$195.00 | 50 amp Current Transducer |

Chilled Water Replacement Parts Index

CWMC-OTS Electric Boxes (Chilled Water Master Control "Off the Shelf")

This electric box can be used with 2 to 6 stage MCW chillers with DDC controls as either a field retrofit (see notes below) or it can be ordered with a new chiller. The box contains the CWMC circuit board, SW & CW pump contactors (and overloads if 3 ph), a term. block for pump & power connections, and the CWMC display in the lid. Circuit breakers are not included.

| <u>Item No.</u> | <u>List Price USD</u> | <u>Description</u> |
|-----------------|-----------------------|------------------------------------------------------------|
| 263600141 | \$1,900.00 | Single phase CWMC-OTS box with two 230VAC pump contactors. |
| 263600142 | \$1,900.00 | Single phase CWMC-OTS box with two 115VAC pump contactors. |
| 334619 | \$605.00 | CWMC Display, Black |

Notes:

1. Box dimensions: Standard is 14"Hx12"Wx4.7"D, add 1 or 2 pumps and dimensions are 11"Hx15"Wx4.7"D.
2. Need to specify 3 phase pump volts & amps and/or horsepower when ordering 3 phase boxes.
3. 380-460VAC power supplied chillers should use the 230VAC pump contactor OTS boxes.

HARNESS

| | | |
|---------|----------|-----------------------------------------------------------------------|
| 4160099 | \$410.00 | Harness, MTD for Secondary LPS, no solenoid coil, no flow switch reed |
| 4160051 | \$390.00 | Replacement Kit MTA/B-MTC, no solenoid coil, no flow switch reed |

HYDROMATIC SERVICE SENSORS

| | | |
|--------|----------|--------------------------------|
| 333972 | \$110.00 | Sensor Hydro/XTC SRV 20' cable |
| 330926 | \$110.00 | Sensor Hydro/XTC 25' cable |
| 330941 | \$200.00 | Sensor Hydro/XTC 50' cable |

INDICATOR LIGHT

| | | |
|--------|---------|-----------------------------|
| 360555 | \$23.00 | Green Indicator Light 28VAC |
|--------|---------|-----------------------------|

MECHANICAL 3-KNOB THERMOSTATS AND PARTS

| | | |
|-----------|----------------|-----------------------------------------------------|
| 019608 | Call For Price | Terminal Strip Cover, 8 Lug, Plastic |
| 019700 | \$27.00 | Switch Assembly Cover, Plastic |
| 4060603 | \$105.00 | Thermostat Anticipating Heat and Cool, SA3/SSA3/DSA |
| 332704 | \$95.00 | Thermostat Anticipating *Cool Only, C12-5187 |
| 4020800 | \$85.00 | Switch, 3 Position, Rotary, SA1/SA3/SSA3/DSA |
| 4023500 | \$45.00 | Switch, 3 Position, Rotary |
| 4023600 | \$65.00 | Switch, 2 Position, Rotary 2-Speed Fan |
| 5090900 | \$14.00 | Knob Black for Mylar |
| 297000044 | \$105.00 | A-4215, Rotary Fan Speed Control, 115V |
| 297000046 | \$105.00 | A-4216, Rotary Fan Speed Control, 230V |

POWER SUPPLIES

| | | |
|---------|------------|--------------------------------------------------------------|
| 337488 | \$160.00 | Power Supply 115/230-24VDC 4.2A |
| 337129 | \$2,470.00 | Single-Phase drives, POWER+ 12 A, 200-240 VAC 1PH, IP20/IP44 |
| 4250025 | \$225.00 | VFD Modbus Cable |

PRESSURE RELIEF VALVE

| <u>Part #</u> | <u>List Price (USD)</u> | <u>Description</u> |
|---------------|-------------------------|--------------------------------|
| 3080053 | \$395.00 | Valve, Relief 600PSI 3/8"x1/2" |
| 3080054 | Call For Price | Valve, Relief 450PSI 3/8"x1/2" |

Chilled Water Replacement Parts Index

SWITCHES

| <u>Part #</u> | <u>List Price (USD)</u> | <u>Description</u> |
|-----------------------------------|-------------------------|--------------------------------------------------------------------------|
| <u>DDC Remote Switches</u> | | |
| 263600104 | \$230.00 | 1-Stage DDC Remote Switch, 25ft harness |
| 263600107 | \$380.00 | 2-Stage DDC Remote Switch, 25ft harness |
| 263600108 | \$455.00 | 3-Stage DDC Remote Switch, 25ft harness |
| 263600114 | \$465.00 | 4-Stage DDC Remote Switch, 25ft harness |
| <u>Rocker Switches</u> | | |
| 331847 | \$23.00 | Rocker pump selector switch w/ dash and circle |
| 333708 | \$5.36 | Rocker switch used with CHC DDC, 10A SPDT |
| <u>Safety Switches</u> | | |
| 263400005 | \$270.00 | Hi Limit - high-temperature safety switch, 24V (replaces 332241) |
| 263400006 | \$270.00 | Freeze Stat - low-temperature safety switch, 24V (replaces 332242) |
| 360518 | \$155.00 | Freeze Stat - low-temperature safety switch, 220V (for MCP linevolt) |
| <u>Flow Switches</u> | | |
| 332025 | \$175.00 | Flow Switch (V10), Brass Body with Reed Switch |
| 4020013 | \$205.00 | Flow Switch Black Plastic (not interchangeable with 332025 switch above) |
| 333361 | \$80.00 | Replacement Reed Switch for V10 Flow Switch 332025 |
| 297704439 | \$240.00 | A-400, Flow Switch with Resistor, Cut Paddle |
| 297704443 | \$105.00 | A-403, Flow Switch Replacement Reed with Resistor for #1061700 |

TIME DELAY

| | | |
|---------|---------|--------------------------------------|
| 4135502 | \$38.00 | Time Delay (delay on make 18-240VAC) |
|---------|---------|--------------------------------------|

TEMPERATURE SENSORS

| | | |
|-----------|----------|---------------------------------------------------------------|
| 297000051 | \$140.00 | A-415, Replacement Temp Sensor for A-350 Controls (MPA units) |
| 4062305 | \$85.00 | Replacement Temp Sensor, TWLC (MPE) and Ranco ETC (MPC) |

TRANSFORMER

| <u>Part #</u> | <u>List Price (USD)</u> | <u>Description</u> |
|---------------|-------------------------|---------------------------------------------------|
| 332707 | \$650.00 | Transformer, multi-primary/24VAC secondary, 150VA |
| 332501 | \$210.00 | Transformer, 380VAC primary/240VAC secondary |

CONDARIA

Chilled Water Parts List

| Item Number | List Price USD | Description |
|-------------------------------------------------------------------------------|----------------|--------------------------------------------------------------|
| Personal Climate Control System (Series 7) | | |
| Series 7 Displays | | |
| 530700050 | \$310.00 | Personal Climate Display VIMAR ARKE BLACK |
| 530700060 | \$310.00 | Personal Climate VIMAR ARKE WHITE |
| 530700110 | \$310.00 | Personal Climate Axolute & Air |
| 530700010 | \$310.00 | Personal Climate VIMAR IDEA |
| 530700040 | \$310.00 | Personal Climate Vimar EIKON-EVO |
| MBS 7 and ABS 7 Control Board with Enclosure | | |
| 530703010 | \$730.00 | Personal Climate MBS-7 3 Speed Main Board |
| 530703030 | \$325.00 | Personal Climate ABS-7 3 Speed Slave Board |
| 530710060 | \$770.00 | Personal Climate MBS-7 10 Speed Main Board |
| 530710080 | \$325.00 | Personal Climate ABS-7 10 Speed Slave Board |
| Series 7 Air Handler Junction Box | | |
| 530241000 | \$70.00 | Single Ventilator Junction Box with Board and Harness |
| 530241005 | \$80.00 | Twin Ventilator Junction Box with Board and Harness |
| Top Climate Control System (Series 3 and Series 6) | | |
| Displays for Series 3 through Series 6 | | |
| 530000131 | \$375.00 | Top Climate Display Vimar Idea (type) for MBS 3-6 |
| 530000200 | \$375.00 | Top Climate Display Living & Light tech (type) for MBS 3-6 |
| 530000110 | \$375.00 | Top Climate Display Axolute (type) for MBS 3-6 |
| 530000120 | \$375.00 | Top Climate Display Vimar Eikon (type) for MBS 3-6 |
| MBS 3-6 and ABS3-6 Control Board with Enclosure | | |
| 530000080 | \$670.00 | Top Climate MBS-3 3 Speed Main Board |
| 530000160 | \$325.00 | Top Climate ABS-3 3 Speed Slave Board |
| 530000128 | \$900.00 | Top Climate MBS-3 10 Speed Main Board |
| 530000090 | \$565.00 | Top Climate MBS-6 3 Speed Main Board |
| 530000100 | \$350.00 | Top Climate ABS-6 3 Speed Slave Board |
| 530000010 | \$790.00 | Top Climate MBS 6-10 Speed Main Board |
| 530000020 | \$670.00 | Top Climate ABS 6-10 Speed Slave Board |
| Climate Organizer Control System Parts | | |
| 530000132 | \$375.00 | Climate Organizer Display Black (Clio) for MBS 2 |
| 530000133 | \$375.00 | Climate Organizer Display White (Clio) for MBS 2 |
| 530000129 | \$660.00 | Climate Organizer (CLIO) MBS-2 3 Speed Control Board |
| 530000160 | \$325.00 | Top Climate ABS-3 3 Speed Slave Board |
| Air Handler Ventilator Assemblies (capacitors not included) | | |
| 6080610 | \$520.00 | Mini & Compact |
| 6080620 | \$740.00 | Junior |
| 6080560 | \$770.00 | Giant 4 & Giant 8 |
| 6080643 | \$400.00 | AP M |
| 6080640 | \$510.00 | AP 1 & AP3 |
| 6080650 | \$530.00 | AP 5 |
| 6080667 | \$1180.00 | AP8 & AP 10 (not insulated intend to just change the motor) |
| 6080580 | \$1520.00 | AP 12 (not insulated intend to just change the motor) |
| Series 7- 10 Speed Ventilator Capacitors (Metal Capacitor without box) | | |
| 530080000 | \$24.00 | APM Run Capacitor 10 Speed (1,5 uF) |
| 530080010 | \$24.00 | AP1, AP3, Twin 12, G4, G8 8 Run Cap. 10 Speed (2 uF) |
| 530080020 | \$24.00 | AP5, Twin 18 Run Capacitor 10 Speed (4uf) |
| 530080030 | \$24.00 | AP8, AP10 Run Capacitor 10 Speed (6uf) |
| 530080040 | \$24.00 | AP12 Run Capacitor 10 Speed (8 uF) |

CONDARIA

Chilled Water Parts List

| Item Number | List Price USD | Description |
|---------------------------------------------------------------|----------------|----------------------------------------------------------|
| MBS 3-6 Compatible 3 Speed Capacitor Assembly with Box | | |
| 530079000 | \$ 220.00 | AP M (3 speed) |
| 530079010 | \$ 220.00 | AP 1, AP3, Twin 12, Giant 4, Junior, Giant 8 (3 speed) |
| 530079020 | \$ 220.00 | AP 5, Twin 18 (3 speed) |
| 530079030 | \$ 220.00 | AP 8 & AP 10 (3 speed) |
| 530079050 | \$ 220.00 | AP 12 (3 speed) |
| MBS 3- 6 Compatible 10 Speed Capacitor Assemblies: | | |
| 530077070 | \$ 148.00 | AP M (10 speed) |
| 530077040 | \$ 148.00 | AP 1, AP3, Twin 12, Junior, Giant 4, Giant 8 (10 speed) |
| 530077050 | \$ 148.00 | AP 5, Twin 18 (10 speed) |
| 530077060 | \$ 148.00 | AP 8 and AP 10 (10 speed) |
| 530077090 | \$ 148.00 | AP 12 (10 speed) |
| Air Handler Sensors | | |
| 530000210 | \$55.00 | Air Sensors for All Condaria Air Handler Controls |
| 5330250 | \$55.00 | Water Sensor for Air Handlers and Chillers |
| 530000230 | \$55.00 | Series 7 Water Sensor with J Box Plug |
| Air Handler 3 Way 4 Port Water Valves and Parts | | |
| 5302370 | \$150.00 | 3 Way Valve Johnson Cont. Solenoid |
| 5302390 | \$150.00 | 3 Way Valve Solenoid for Sauter |
| 5302302 | \$300.00 | 3 Way Valve Body Sauder BUL15 |
| 529001025 | \$450.00 | 3 Way 4 port Valve Complete for Condaria 220V 1PH Sauter |
| Chiller Control Boards: | | |
| 5330220 | \$1110.00 | Chiller Organizer -1 Compressor Main Board |
| 5330230 | \$1275.00 | Chiller Organizer -2 Compressor Main Board |
| 5330010 | * | Obsolete Chiller Organizer 2 -3 Comp. M/B use 5330210 |
| 5330020 | * | Obsolete Chiller Organizer 2 -4 Comp. M/B use 5330200 |
| 5330210 | \$1600.00 | Chiller Organizer 2/3 -3 Comp. Main Board |
| 5330200 | \$1600.00 | Chiller Organizer 2/3 -4 Comp. Main Board |
| 5330170 | * | Obsolete Easy Chiller - 1 Comp/3 Sensor Main Board* |
| 5330180 | * | Obsolete Easy Chiller - 2 Comp/3 Sensor Main Board* |
| 5330545 | \$1070.00 | Easy Chiller - 1 Comp/4 Sensor Main Board* |
| 5330540 | \$1190.00 | Easy Chiller - 2 Comp/4 Sensor Main Board* |
| * contact service department before ordering these boards. | | |
| Chiller Control Displays: | | |
| 533000025 | \$400.00 | Chiller Organizer PRIMARY Display, 1 Compressor |
| 533000020 | \$400.00 | Chiller Organizer PRIMARY Display, 2 Compressor |
| 533000010 | \$1350.00 | Chiller Organizer 2/3 PRIMARY Display - 3 or 4 Comp. |
| 5330090 | \$435.00 | Easy Chiller Display 1 or 2 comp. (board only) |
| 533000300 | \$1350.00 | Easy Chiller/Top Chiller Remote Network Ready Display |
| Chiller Miscellaneous Parts: | | |
| 5330250 | \$55.00 | Water and Freeze Sensor Chillers |
| 5240220 | \$100.00 | Pressure Gauge Condaria |
| 5270320 | \$150.00 | Pressure Differential Switch |
| 5270010 | \$551.00 | Flow Switch Caleffi 1 " |
| 5270090 | Call for Price | Sika Flow Switch (Plastic Paddle) For PCWM 410a systems |

CONDARIA

Chilled Water Parts List

| Item Number | List Price USD | Description |
|-------------------------|----------------|-------------------------------------------------|
| Pumps | | |
| 6230780 | \$1650.00 | Sea Water BCM20/A 230V/1/50-60 |
| 6230260 | \$1900.00 | Sea Water BCM22/A 230V/1/50-60 |
| 6230370 | \$1150.00 | Circulation Pump CM 22 E/R 230/60/1 |
| 6230840 | \$1244.00 | Circulation Pump NMM25/12 230V/1/50-60 |
| 6230830 | \$2200.00 | Sea Water Pump BNMM25/12 230 60/1 |
| 6230301 | \$2310.00 | Sea Water Pump BC41/1E 230 50-60/1 |
| Pump Spare Parts | | |
| 6260190 | \$260.00 | Pump Seal Kit (diam. 12MM) BCM20, BCM 22, NMM25 |
| 6260195 | \$350.00 | Pump Seal Kit (diam. 18MM) BC41 E |
| 6260210 | \$13.00 | Pump Head Gasket for BCM 20 |
| 6260220 | \$17.00 | Pump Head Gasket for BCM 22 and NMM25 |
| 6260230 | \$25.00 | Pump Head Gasket for BCM 41 E |
| 6260300 | \$25.00 | Pump Head Gasket for BNMM25/12 |
| 6260011 | \$22.00 | Pump Capacitor 10 MF |
| 6260010 | \$26.00 | Pump Capacitor 12.5 MF |
| 6260020 | \$30.00 | Pump Capacitor 16 MF |
| 6260030 | \$35.00 | Pump Capacitor 20 MF |
| 6260040 | \$39.00 | Pump Capacitor 25MF |

REFRIGERATION

Grunert Refrigeration Systems

PASSAGEMAKER - AC Voltage Condensers (R404A Low Temp "400 Series")

Condensers for all applications.

| Item | List Price USD | Model | Description |
|-----------|----------------|----------|---------------------------------------------|
| 256000120 | \$2,940.00 | AC425 | 1/4 HP Hermetic, 404A, 115 Volt |
| 256000149 | \$3,655.00 | AC425HA | 1/4 HP Hermetic, 404A, 115 Volt Air / Water |
| 256000122 | \$3,770.00 | AC450 | 1/2 HP Hermetic, 404A, 115 Volt |
| 256000148 | \$4,075.00 | AC450HA | 1/2 HP Hermetic, 404A, 115 Volt Air / Water |
| 256000123 | \$3,770.00 | AC450Z | 1/2 HP Hermetic, 404A, 230 Volt |
| 256000174 | \$3,895.00 | AC475 | 3/4 HP Hermetic, 404A, 115 Volt |
| 256000175 | \$4,190.00 | AC475HA | 3/4 HP Hermetic, 404A, 115 Volt Air / Water |
| 256000177 | \$4,970.00 | AC475Z | 3/4 HP Hermetic, 404A, 230 Volt |
| 256000187 | \$5,015.00 | AC475Z50 | 3/4 HP Hermetic, 404A, 220 Volt, 50Hz |

CAPACITIES:

Equipment operated at 60 cycles will run at 100% rated capacity.

Equipment operated at 50 cycles will run at 82% rated capacity.

VOLTAGE REQUIREMENTS:

Add "Z" to Model Number for all 230 volt equipment.

When 60 cycle equipment is operated at 50 cycles with line voltage in excess of 220 volts, a step-down transformer

MUST be used in conjunction with the equipment in order to reduce the line voltage to the recommended 200 or

220 volt range. See the Additional Components section for step-down transformer # 335894.



Passagemaker AC450

TYPICAL TWO BOX APPLICATION COMPONENTS LIST & RELATED NOTES

A typical two box application that has one refrigerator box and one freezer box should consist of the following:

- 1) The condensing unit. Or two condensing units, one AC & one DC, if it is a dual circuit application as well.
- 2) Solenoid Valve Tee assembly (one per condensing unit), 12VDC solenoid for use with AC condenser, or DC solenoid must match the DC condensing unit's voltage (12, 24 or 32).
- 3) Check Valve Tee assembly (one per condensing unit).
- 4) Expansion Valves: Two per condensing unit, one for each box of a single circuit or two for each box of a dual circuit. Valves must be ordered specifically for the capacity of the plate(s), type of box (refer or freezer), and refrigerant used.
- 5) T-Stats: Two per condensing unit (one for each box of a single circuit or two for each box of a dual circuit). T-Stats must ordered specifically for the type of box (refer or freezer) and the temperature of the holdover plate(s).
- 6) In a single circuit application the holdover plates will have crossovers while in a dual circuit system they will not.
- 7) A dual circuit system, with one AC condenser & one DC condenser, requires one AC pump & one DC pump.
- 8) Refer to drawing G2030015 in the Grunert AC/DC manual for a sample schematic of a two box, dual circuit system.
- 9) Solenoid Valves and Check Valves are not needed for single box applications.
- 10) Seawater pump(s) and related components to be sized for condensing unit(s).

REFRIGERATION

Grunert Refrigeration Systems

| HOLDOVER PLATES - Stainless Steel, DUAL Circuit | | | | |
|--------------------------------------------------------|-----------------------|---------------------|-------------------|-------------------------------|
| Special order - call for pricing | | | | |
| <u>Item</u> | <u>List Price USD</u> | <u>Model Number</u> | <u>Plate BTUs</u> | <u>Description</u> |
| -9° Freezer, 3 3/8" Thick | | | | |
| 257000211 | Call for Pricing | 24X13 ML-FLR | 2984 | PLATE SS -9 DUAL 24X13 ML-FLR |
| 0° Freezer, 3" Thick | | | | |
| 257000213 | Call for Pricing | 16X10 ML-FLR | 1536 | PLATE SS 0 DUAL 16X10 ML-FLR |
| 257000240 | Call for Pricing | 16X14 4"-STB | 2118 | PLATE SS 0 DUAL 16X14 4"-STB |
| 257000214 | Call for Pricing | 16X14 ML-FLR | 2118 | PLATE SS 0 DUAL 16X14 ML-FLR |
| 26° Refrigerator, 3" Thick | | | | |
| 257000247 | Call for Pricing | 16X14 4"-STB | 2356 | PLATE SS 26 DUAL 16X14 4"-STB |
| 257000221 | Call for Pricing | 16X14 ML-FLR | 2356 | PLATE SS 26 DUAL 16X14 ML-FLR |
| 257000248 | Call for Pricing | 20X10 4"-STB | 2174 | PLATE SS 26 DUAL 20X10 4"-STB |
| 257000251 | Call for Pricing | 24X13 4"-STB | 3469 | PLATE SS 26 DUAL 24X13 4"-STB |
| 257000225 | Call for Pricing | 24X13 ML-FLR | 3469 | PLATE SS 26 DUAL 24X13 ML-FLR |

| HOLDOVER PLATES - Stainless Steel, SINGLE Circuit | | | | |
|----------------------------------------------------------|-----------------------|---------------------|-------------------|--------------------------------|
| Special order - call for pricing | | | | |
| <u>Item</u> | <u>List Price USD</u> | <u>Model Number</u> | <u>Plate BTUs</u> | <u>Description</u> |
| -18° Freezer, 3 3/8" Thick | | | | |
| 257000330 | Call for Pricing | 24X13 ML-FLR | 3086 | PLATE SS -18 SNGL 24X13 ML-FLR |
| -9° Freezer, 3 3/8" Thick | | | | |
| 257000331 | Call for Pricing | 12X10 ML-FLR | 1023 | PLATE SS -9 SNGL 12X10 ML-FLR |
| 257000335 | Call for Pricing | 20X8 ML-FLR | 1480 | PLATE SS -9 SNGL 20X8 ML-FLR |
| 257000337 | Call for Pricing | 24X13 ML-FLR | 2984 | PLATE SS -9 SNGL 24X13 ML-FLR |
| 0° Freezer, 3" Thick | | | | |
| 257000365 | Call for Pricing | 16X10 4"-STB | 1536 | PLATE SS 0 SNGL 16X10 4"-STB |
| 257000339 | Call for Pricing | 16X10 ML-FLR | 1536 | PLATE SS 0 SNGL 16X10 ML-FLR |
| 257000366 | Call for Pricing | 16X14 4"-STB | 2118 | PLATE SS 0 SNGL 16X14 4"-STB |
| 257000340 | Call for Pricing | 16X14 ML-FLR | 2118 | PLATE SS 0 SNGL 16X14 ML-FLR |
| 26° Refrigerator, 3" Thick | | | | |
| 257000345 | Call for Pricing | 12X10 ML-FLR | 1243 | PLATE SS 26 SNGL 12X10 ML-FLR |
| 257000346 | Call for Pricing | 16X10 ML-FLR | 1708 | PLATE SS 26 SNGL 16X10 ML-FLR |
| 257000377 | Call for Pricing | 24X13 4"-STB | 3469 | PLATE SS 26 SNGL 24X13 4"-STB |
| 257000351 | Call for Pricing | 24X13 ML-FLR | 3469 | PLATE SS 26 SNGL 24X13 ML-FLR |

| THERMOSTATS | | | |
|--------------------|-----------------------|---------------------|------------------------------------------------------------|
| <u>Item No.</u> | <u>List Price USD</u> | <u>Model Number</u> | <u>Description</u> |
| 259200100 | \$195.00 | T-STAT-I-R | Refrigeration T-Stat Assy. - Internal, 26 degree F plates |
| 259200250 | \$135.00 | T-STAT-B-R | Refrigeration T-Stat Assy. - Bulkhead Mount, 26 deg F |
| 259200200 | \$175.00 | T-STAT-I-F | Freezer T-Stat Assy. - Internal, 0 degree F plates |
| 259200260 | \$125.00 | T-STAT-B-F | Freezer T-Stat Assy. - Bulkhead Mnt, 0 degree F plates |
| 259200504 | \$280.00 | T-STAT-I -9 / -18 | Freezer T-Stat Assy. - Internal, -9 & -18 degree F plates |
| 259200505 | \$200.00 | T-STAT-B -9 / -18 | Freezer T-Stat Assy. - Bulkhead Mnt, -9 & -18 deg F plates |

REFRIGERATION

Grunert Refrigeration Systems

| EXPANSION VALVES | | | |
|----------------------------------------------------------------------------------------------------------------------------|---------------------------------------------------|----------------------------------------------|-------------------------------------------------------|
| Expansion Valve Size | Total Refrigerator Holdover Plate Capacity | Total Freezer Holdover Plate Capacity | |
| 1/4 | 1000-3800 BTU | 1000-3200 BTU | |
| 1/2 | 3800-7000 BTU | 3200-6100 BTU | |
| 1 | 7000-13000 BTU | 6100-11400 BTU | |
| Item | List Price USD | Model | Description |
| R404A EXPANSION VALVES | | | |
| 259332691 | \$235.00 | EV 1/4R-404A | Expansion Valve 1/4 - Refrigerator (R404A) |
| 259332692 | \$235.00 | EV 1/4F-404A | Expansion Valve 1/4 - Freezer (R404A) |
| 259332462 | \$135.00 | EV1/2R-404A | Expansion Valve 1/2 - Refrigerator (R404A) |
| 259332463 | \$135.00 | EV1/2F-404A | Expansion Valve 1/2 - Freezer (R404A) |
| 259332686 | \$130.00 | EV1R-404A | Expansion Valve 1 - Refrigerator (R404A) |
| 259332687 | \$130.00 | EV1F-404A | Expansion Valve 1 - Freezer (R404A) |
| R134A EXPANSION VALVES | | | |
| 259331456 | \$130.00 | EV1/4R -409/134 | Exp. Valve 1/4 - Refrigerator (R409A, R12, or R134A) |
| 259331457 | \$130.00 | EV1/4F -409/134 | Exp. Valve 1/4 - Freezer (R409A, R12, or R134A) |
| 259331458 | \$130.00 | EV1/2R -409/134 | Exp. Valve 1/2 - Refrigerator (R409A, R12, or R134A) |
| 259331459 | \$130.00 | EV1/2F -409/134 | Exp. Valve 1/2 - Freezer (R409A, R12, or R134A) |
| Note: These expansion valves are factory set for R134A. They may require field adjustment if used for R12 or R409A. | | | |

| PUMPS | | | |
|--------------------------------------------------------------------------|-----------------------|--------------|--------------------------------------------------------|
| Item | List Price USD | Model | Description |
| DC CENTRIFUGAL MAGNETIC DRIVE SEAWATER PUMPS | | | |
| 225500018 | \$440.00 | PML150/12V | P-800 with bracket, 2 GPM @ 7' head . |
| 225500019 | \$820.00 | P900-12V | P-900 - 12 Volt, 4.3GPM @ 7.5' head, 3.6GPM @ 10' head |
| 225500022 | \$820.00 | P900-24V | P-900 - 24 Volt, 4.3GPM @ 7.5' head, 3.6GPM @ 10' head |
| Note: P-900 contains replaceable brushes (see pump parts section) | | | |

| ADDITIONAL COMPONENTS | | | |
|------------------------------|-----------------------|----------------|-----------------------------------------------------|
| Item | List Price USD | Model | Description |
| SOLENOID VALVES | | | |
| 259100300 | \$305.00 | SVC 12VLT | Solenoid Valve/Coil Assembly, 12 Volt |
| 259100050 | \$625.00 | 1/4"TEE, 12VLT | Solenoid "T" Assembly, 12 Volt |
| CHECK VALVES | | | |
| 338568 | \$85.00 | 1/2"CV | 1/2" Check Valve |
| 259100200 | \$335.00 | 1/2"CV TEE | 1/2" Check Valve Tee Assembly |
| MISCELLANEOUS | | | |
| 338630 | \$235.00 | RDT | Remote Dial Thermometer (3.5" dia, -20>120 degrees) |
| 291510044 | \$135.00 | TRANS w/PLATE | Transformer MAG FD8-16 with mounting plate |
| 332897 | \$15.00 | RELAY12VDC | Pump Relay for PM, 12VDC SPNO 40A w/ mounting ear |

REFRIGERATION

Grunert Refrigeration Systems

| PARTS | | | |
|-----------------------------------------------------------------------------------------------------------------------------------|-----------------------|------------------|----------------------------------------------------------------|
| Item | List Price USD | Model | Description |
| THERMOSTAT PARTS | | | |
| 338551 | \$85.00 | TSTAT-REFER | Thermostat, w/72" Cap RFG w/Off A30-544/72" Cap RFG |
| 338752 | \$85.00 | TSTAT-FRZR | Thermostat, w/72" Cap FRZR w/Off A30-2290-00 |
| Note: The above replacement thermostats do not have a plate and are not used with Polar Mates. | | | |
| QUICK DISCONNECT "QD" or "QC" FITTINGS FOR POLAR MATES | | | |
| 338484 | \$55.00 | M1/4"AER4/8/5502 | Male #5 QD for FL-built Polar Mates (thru early 2001) |
| 338485 | \$55.00 | F1/4"AER4/8/5505 | Female #5 QD for FL-built Polar Mates (thru early 2001) |
| 3123940 | \$55.00 | M1/4"5502-04B-06 | Male #4A QC for VA-built Polar Mates (2001 to present) |
| 3123930 | \$55.00 | F1/4"5505-04B-06 | Female #4A QC for VA-built Polar Mates (2001 to present) |
| FILTERS / DRIERS | | | |
| 369591 | \$28.00 | FLTR DR 1/4" | Filter / Drier for AC25, AC425, AC16HA, and AC416HA |
| 338541 | \$38.00 | FLTR DR C082 | F/D for AC450-4100, AC50-100, DC425-4100, DC25-100, A-HX-R |
| 332717 | \$85.00 | FLTR DR C083 | Filter / Drier for AC4150 & AC4200 |
| CONDENSER FANS | | | |
| 338801 | \$155.00 | FAN BSDR 12V | Fan for Baysider 12V |
| 330367 | \$320.00 | FAN DOCK 115V | Fan for AC416, AC16, 115V |
| 263400643 | \$630.00 | FAN ACHA 10" 12V | Fan, Field Replacement kit, for AC-HA units, 10" max flow, 12V |
| WATER-COOLED CONDENSER COILS | | | |
| 297606603 | \$740.00 | CL CND AC475 | Coil for AC475 - 2003 units w/item no. 25600017# |
| 369627 | \$335.00 | CL CND AC50-75 | Coil for AC50 - 75 |
| 331235 | \$450.00 | CL CND AC100-150 | Coil for AC100 - 150 |
| PRESSURE SWITCHES | | | |
| 332590 | \$100.00 | PSHG 400PSI | High Press 400psi OFF / 300psi ON, R22, and R406 systems |
| 332468 | \$185.00 | PSHG 200PSI | High Press 200psi OFF / 150psi ON, R12, R134A, R406, R409A |
| AC PAINTED COMPRESSORS, 400 SERIES | | | |
| 293013105 | \$1,035.00 | For AC450(HA) | 1/2 HP Hermetic, 404A, 115 Volt |
| 293045161 | \$1,020.00 | For AC450Z | 1/2 HP Hermetic, 404A, 230 Volt |
| 293013106 | \$1,175.00 | For AC475(HA) | 3/4 HP Hermetic, 404A, 115 Volt |
| Compressors for all Evaporator Plates or 26O Refrigerator & 0O Freezer Holdover Plates. | | | |
| NOTE: SPECIAL PRICING MAY BE AVAILABLE FOR THESE COMPRESSORS, CONTACT SALES TEAM. | | | |
| SOLENOID COILS | | | |
| 4070009 | \$130.00 | SC12 | Solenoid Coil, 12 Volt, 10 Watt |
| DC MOTORS | | | |
| 338712 | \$1,270.00 | MTR 1/4HP 12V | Motor 1/4HP, 12VDC for DC425 |
| DC BELT-DRIVEN COMPRESSORS | | | |
| Compressors are no longer available, see Field Notice 210-J3 on the Customer News and Information website. | | | |
| BELTS | | | |
| For units manufactured starting November 1, 2003: | | | |
| 332066 | \$80.00 | AX28 | 30" OD Belt, AX-28 for DC425-450BD |
| BRUSHES FOR LEESON DC MOTORS (on units built after 1990) | | | |
| Price per brush (not sold in pairs). | | | |
| 330300 | \$175.00 | BRSH 12V | Brush 12V DC motor for 1/4HP, 1/3HP, 1/2HP and 1HP |
| O-RING TO FLARE ADAPTERS FOR ENGINE DRIVEN (ED): | | | |
| This kit includes the inserts and O-rings to convert the ports (suction and hot gas compressor) of the ED75 to flare connections. | | | |
| 332071 | \$5.36 | KIT ORING / FL | O-ring to flare adapter kit for ED75 (R12, R134A, R409A) |

FLAT EVAPORATOR PLATES - Stainless Steel Wet and Dry Plates

Grunert offers two types of flat evaporator plates. The first style is constructed of 316 stainless steel and all seams are welded. It is designed to be used in a "wet" application in either a cockpit cooler or freezer that may contain salt or fresh water. The second is constructed of 304 stainless steel to be used in a "dry" application, i.e. drink box, bait freezer or standard refrigeration. There are no standard sizes, because all flat evaporator plates are custom built.

All custom plates must have customer sign-off prior to initiation of manufacturing.
If interested in these items, please contact your Sales Representative.

| REV | DATE | REVISION DESCRIPTION | DWG | APR |
|-----|----------|--------------------------------------------|-----|-----|
| J | 9/27/01 | UPDATE PRICING CALCULATIONS,CAD964-01 | DRR | RAP |
| K | 9/28/01 | REVERSE WET & DRY VALUES,ADD 144,CAD969-01 | DRR | RAP |
| L | 10/29/01 | REMOVE SWAGELOK FITTINGS,CAD1062-01 | DRR | RAP |
| M | 2/3/04 | UPDATED TO 2004 PRICES,CAD070-04 | DRR | RAP |
| | | | | |

PROPRIETARY NOTE: THE INFORMATION CONTAINED WITHIN THIS DOCUMENT IS THE PROPERTY OF DOMETIC CORPORATION. ANY ATTEMPT TO COPY OR DISTRIBUTE WITHOUT WRITTEN CONSENT FROM DOMETIC CORPORATION SHALL BE CONSIDERED UNLAWFUL AND CAN BE CONTESTED IN A COURT OF LAW.

FLAT EVAPORATOR PLATE SPECIFICATIONS

- Stainless steel outer shell (dry plate with 304SST, wet plate with 316L SST)
- 3/8" O.D. tube core and refrigerant connections:
Stainless steel for wet plates,
Copper for dry plates.
- Slim profile (9/16" thick)

WIDTH _____"/cm x HEIGHT _____"/cm = _____ TOTAL SQUARE INCHES OR CENTIMETERS

NOTE: First dimension of model number indicates width in inches, second dimension indicates height in inches.

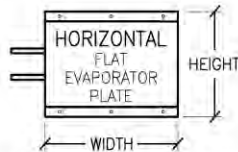

Complete this section for a HORIZONTAL plate:

- 1) Choose either WET or DRY plate (circle one).
- 2) Specify WIDTH of plate _____
(8.0"/20.3cm min. and 44.0"/111.8cm max.)
- 3) Specify HEIGHT of plate _____
(7.5"/19.1cm min. and 45.75"/116.2cm max.)
- 4) Length of 3/8"ø O.D. refrigerant extensions:
(8.0"/20.3cm is standard) _____
- 5) Location of extensions (circle one):
TOP / CENTER / BOTTOM (center is standard)
- 6) If extensions not center, distance from outside flange: (2.0"/5.1cm min.) _____
- 7) Refrigerant extension fitting type (circle one):
FLARE / QD / NONE

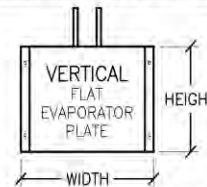

Complete this section for a VERTICAL plate:

- 1) Choose either WET or DRY plate (circle one).
- 2) Specify WIDTH of plate _____
(9.5"/24.2cm min. and 45.5"/115.6cm max.)
- 3) Specify HEIGHT of plate _____
(6.0"/15.2cm min. and 44.25"/112.4cm max.)
- 4) Length of 3/8"ø O.D. refrigerant extensions:
(8.0"/20.3cm is standard) _____
- 5) Location of extensions (circle one):
LEFT / CENTER / RIGHT (center is standard)
- 6) If extensions not center, distance from outside flange: (2.0"/5.1cm min.) _____
- 7) Refrigerant extension fitting type (circle one):
FLARE / QD / NONE

MOUNTING CONSIDERATIONS (PLATES ARE POSITION SENSITIVE):
Horizontal plates can be mounted with the refrigerant extensions going left or right, but the refrigerant must always feed into the bottom tube. Vertical plates can be mounted with the refrigerant extensions going up or down, but the refrigerant must always feed into the tube on the right. These guidelines apply while looking at the finished surface on front of a plate. Plates used as shelves may be fed from either tube. Plates have 3/4" mounting flanges with 1/4" holes.



CUSTOMER SIGNOFF

DATE: _____
COMPANY NAME: _____
YACHT MODEL: _____
SIGNATURE: _____
PRINT NAME: _____

| | | | |
|-------------------------------------------------|-------------|----------------|-------|
| Dometic Corporation | | Grunert | |
| FLAT EVAPORATOR PLATE RETAIL PRICE WORKSHEET | | | |
| DATE: 3-23-95 | DWG BY: DKM | PART NUMBER: G | DWG |
| SCALE: NTS | APR BY: DTS | N/A | DWG |
| | | G6030002 | REV M |

REFRIGERATION

KRA Refrigeration Units

| KRA 400 Series Titanium Condensing Units - R404A | | |  |
|------------------------------------------------------------------------------------|-------------------------|------------------------------------------------------|-------------------------------------------------------------------------------------|
| <u>Item No.</u> | <u>List Price (USD)</u> | <u>Description</u> | |
| 754000430 | \$2,915.00 | KRA433X 1161 Single No Electric Box Water Cool Only | |
| 754000431 | \$2,915.00 | KRA433X 2371 Single No Electric Box Water Cool Only | |
| 754000439 | \$3,555.00 | KRA433X 1161 Single No Electric Box | |
| 754000440 | \$3,555.00 | KRA433X 2361 Single No Electric Box | |
| 754000435 | \$4,055.00 | KRA433X 1161 Mult2 With Electric Box | |
| 754000441 | \$4,055.00 | KRA433X 2371 Mult2 With Electric Box | |
| 754000444 | \$4,495.00 | KRA450X 1161 Single No Electric Box | |
| 754000465 | \$4,495.00 | KRA450X 2361 Single No Electric Box | |
| 754000461 | \$4,995.00 | KRA450X 1161 Mult3 With electric Box | |
| 754000462 | \$4,995.00 | KRA450X 2361 Mult3 With electric Box | |
| Dual box uses 12V controls Single box uses line duty. | | | |
| Condensing Units - R134A | | |  |
| <u>Item No.</u> | <u>List Price (USD)</u> | <u>Description</u> | |
| 754000100 | \$2,995.00 | KRA025 Air/Water, 1/4 HP, 115V, 60Hz | |
| 754000104 | \$2,985.00 | KRA038 Air/Water, 3/8 HP, 115V, 60Hz | |
| 754000106 | \$3,175.00 | KRA038CK Air/Water, 3/8 HP, 220V, 50Hz | |
| 754000105 | \$3,320.00 | KRA038/M-135 Air/Water 3/8HP 115V ETC T-Stat | |
| 754000108 | \$3,870.00 | KRA050 Air/Water, 1/2 HP, 115V, 60Hz | |
| KRA038CK units replaces KRA025CK units | | | |
| Water-Cooled Only Condensing Units - R134A | | | |
| <u>Item No.</u> | <u>List Price (USD)</u> | <u>Description</u> | |
| 754000110 | \$2,355.00 | KRA025 Condenser 1/4 HP, Water Cool Only, 115V, 60Hz | |
| 754000111 | \$2,615.00 | KRA038 Condenser 3/8HP Water Cool Only, 115V, 60Hz | |
| 754000116 | Call For Price | KRA038CK Condenser 3/8HP Water Cool Only, 220V, 50Hz | |
| KRA038CK units replaces KRA025CK units | | | |
| Evaporator Tubes-R134A (Pre-charged 3/8" copper tubing w/ QC's to wrap box) | | | |
| <u>Item No.</u> | <u>List Price (USD)</u> | <u>Description</u> | |
| 221200518 | \$490.00 | ETA3C50, Evaporator Tube 50' | |
| 221200519 | \$590.00 | ETA3C65, Evaporator Tube 65' | |
| 221200517 | \$800.00 | ETA3C100, Evaporator Tube 100' | |
| 221200521 | \$1,120.00 | ETA3C150, Evaporator Tube 150' | |
| Suction Lines - R134A | | | |
| <u>Item No.</u> | <u>List Price (USD)</u> | <u>Description</u> | |
| 221200589 | \$185.00 | SLA24, Suction Line, Insulated, 24", Copper | |
| 221200543 | \$200.00 | SLA48, Suction Line, Insulated, 48", Copper | |
| 221200571 | \$205.00 | SLA60, Suction Line, Insulated, 60", Copper | |
| 221200513 | \$220.00 | SLA72, Suction Line, Insulated, 72", Copper | |
| 221200516 | \$235.00 | SLA96, Suction Line, Insulated, 96", Copper | |
| 221200636 | \$225.00 | SLA120, Suction Line, Insulated, 120", Copper | |
| 221200539 | \$265.00 | SLA144, Suction Line, Insulated, 144", Copper | |
| 221200560 | \$315.00 | SLA168, Suction Line, Insulated, 168", Copper | |
| 221200582 | \$315.00 | SLA180, Suction Line, Insulated, 180", Copper | |
| 221200541 | \$315.00 | SLA216, Suction Line, Insulated, 216", Copper | |
| 221200583 | \$325.00 | SLA240, Suction Line, Insulated, 240", Copper | |
| 221200544 | \$360.00 | SLA300, Suction Line, Insulated, 300", Copper | |

REFRIGERATION

KRA Refrigeration Units

| Liquid Lines - R134A | | |
|------------------------------------------------------------------------------------------------------------------------------------|-------------------------|----------------------------------------------------------------|
| Item No. | List Price (USD) | Description |
| 221200553 | \$350.00 | LLPA48, Liquid Line w/ CPV, 48" Copper |
| 221200629 | \$400.00 | LLPA72, Liquid Line w/ CPV, 72" Copper |
| 221200559 | \$475.00 | LLPA216, Liquid Line w/ CPV, 216" Copper |
| 221200540 | \$515.00 | LLPA300, Liquid Line w/ CPV, 300" Copper |
| KRA Accessories | | |
| 259000041 | \$160.00 | PJA28x12-S, Plate Jumper, SS, 28" Wide, 12" Legs |
| 238100034 | \$520.00 | LLYA, Liquid Line Splitting Assy, w/ 115V Solenoid Valves |
| 238100035 | \$250.00 | SLYA, Suction Line Splitting Assy |
| 221200545 | \$210.00 | CPV, Constant Pressure Valve with QC & Flare Connections |
| 3123800 | \$100.00 | Constant Pressure Valve, pre-set @3PSI |
| 3123910 | \$55.00 | 3/8" Female Quick-Connect (#5505-06B-06) |
| 3123920 | \$55.00 | 3/8" Male Quick-Connect (#5502-06B-06) |
| 3123930 | \$55.00 | 1/4" Female Quick-Connect (#5505-04B-06) |
| 3123940 | \$55.00 | 1/4" Male Quick-Connect (#5502-04B-06) |
| 754000114 | \$240.00 | TXV assembly, 1/4HP, R134A only |
| 754000113 | \$275.00 | A-130, TXV assembly, 3/8HP, R134Aonly |
| 754000115 | \$255.00 | TXV assembly, 1/2HP, R134A only |
| 4062302 | \$165.00 | ETC Electronic T-Stat, 120/230V, 1-Stage |
| 4062303 | \$325.00 | ETC Electronic T-Stat, 120/230V, 2-Stage |
| 4062309 | \$230.00 | Temp Control TS2 115V, 16A (Temp. sensor purchased separately) |
| 4062310 | \$230.00 | Temp Control TS2 12V, 16A (Temp. sensor purchased separately) |
| 4062311 | \$41.00 | Sensor TS Temp Control 5' |
| Notes: 1. Order 753000128 (A-137) for thermistor cover on above T-Stats. 2. Order A-139 for surface mount kit TS2 Digital T-Stats. | | |
| 336863 | \$34.00 | NTC Bulb Temp Sensor 10ft |
| 337423 | \$42.00 | NTC Bulb Temp Sensor 20ft |
| 337453 | \$65.00 | NTC Bulb Temp Sensor 40ft |
| 753000128 | \$16.00 | A-137, White Thermistor Cover with Screws and Label |
| A-139 | Call For Price | Surface mount kit for TS2 control |
| 758002006 | \$340.00 | Condensing Unit Relay 115V, 2 Triggers |
| 221200581 | Call For Price | Liquid Line Filter Drier with QD |
| Replacement Parts | | |
| 2054216 | \$290.00 | Fan Axial KR025, 038, 425, 450 115VAC |
| 2054217 | \$300.00 | Fan Axial KR025, 038 050, 425, 450 230V 50/60Hz |
| 3023102 | \$405.00 | Coil Condenser Air KR 1/4 & 3/8 |
| 298001127 | \$315.00 | R3600-KRA, Coil Condenser Water KRA 1/4 & 3/8 |
| 336824 | \$600.00 | Compressor, Refrig, 1/4HP, Tecumseh, 115V 60Hz |
| 338132 | \$600.00 | Compressor, Refrig, 1/4HP, Tecumseh, 220V 50Hz |
| 336825 | \$550.00 | Compressor, Refrig, 3/8HP, Tecumseh, 115V 60Hz |
| 3011017 | \$950.00 | Compressor, Refrig, 1/2HP, Tecumseh, 115V 60Hz |
| 044900 | \$28.00 | Overload for 1/4HP & 3/8HP KRA Comps, AEA2410, 2413 |
| 4129010 | \$55.00 | Start Relay for 1/4HP & 3/8HP KRA Comps, AEA2410, 2413 |
| 336669 | \$105.00 | Start Cap for 1/4HP & 3/8HP KRA Comps, AEA2410, 2413 |
| 4040295 | \$38.00 | Start Capacitor for 1/2HP KRA Compressor, AJA2419 |
| 3150404 | \$170.00 | Receiver/filter, 3/8" OD Solder, 8" Tall (KRA Units) |
| 3086800 | \$46.00 | Glass Sight Moisture Indicator, Sweat |
| 722400012 | \$45.00 | A-556, MOV Surge Suppressor (Blue) |
| 4080104 | Call For Price | Strip Terminal 4 Lug |
| 5082410 | \$6.43 | Nut, Well, Threaded Rubber Insert 1/4"x20 |
| 3123751 | \$145.00 | TXV 1/4HP |
| 3123750 | \$145.00 | TXV 3/8HP |
| 3123752 | \$145.00 | TXV 1/2HP |

REFRIGERATION

Adler Barbour DIY Refrigeration

Condensing Units

| Item No. | List Price (USD) | Description |
|-----------|------------------|-------------------------------------------------------------------------------------|
| 755400000 | \$1,240.00 | CU-100, ColdMachine™, Self-Seal QC, Air Cooled, 12VDC |
| 755410000 | \$1,380.00 | CU-200, SuperColdMachine™, Self-Seal QC, Water and Air Cooled, 12VDC |
| CU-54 | \$1,085.00 | 50 Series Condensing Unit, Horizontal, Long Layout, 12/24VDC, Air Cooled only |
| CU-55 | \$1,085.00 | 50 Series Condensing Unit, Square Layout, 12/24VDC, Air Cooled only |
| CU-84 | \$1,150.00 | 80 Series Condensing Unit, Horizontal Layout, 12/24VDC, Air Cooled only |
| CU-85 | \$1,150.00 | 80 Series Condensing Unit, Square Layout, 12/24VDC, Air Cooled only |
| CU-86 | \$1,150.00 | 80 Series Condensing Unit, Vertical or Wall Mount Layout, 12/24VDC, Air Cooled only |

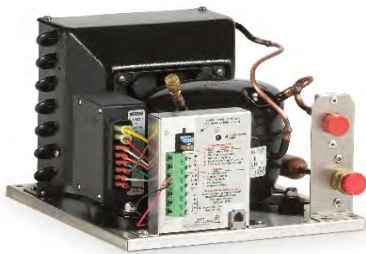

CU-100



CU-200

Evaporators

| Item No. | List Price (USD) | Description |
|------------------------------------------------------------------------------------------|------------------|----------------------------------------------------------------------|
| ColdMachine™ and SuperColdMachine™ (to be used with the CU-100 & CU-200 ONLY) | | |
| 755500000 | \$630.00 | VD-150, Small Vertical Evaporator, Without Door, Self-Seal QC |
| 755510000 | \$630.00 | VD-151, Small Horizontal Evaporator, With Door, Self-Seal QC |
| 755520000 | \$730.00 | VD-152, Large Vertical Evaporator, Without Door, Self-Seal QC |
| 755530000 | \$730.00 | VD-153, Large Horizontal Evaporator, With Door, Self-Seal QC |
| 755560000 | \$1,880.00 | VD-160, Power Plate Evaporator, With Analog Thermostat, Self-Seal QC |



50 Series (to be used with the 50 Series ONLY)

| | | |
|-------|----------|--------------------------------------------------------------|
| VD-01 | \$250.00 | L-Shaped Evap, Horizontal and Vertical Installation |
| VD-02 | \$245.00 | Plate Evap, Horizontal and Vertical Installation |
| VD-07 | \$255.00 | Standard O-Shaped Evap, Horizontal and Vertical Installation |

80 Series (to be used with the 80 Series ONLY)

| | | |
|-------|----------|--------------------------------------------------------------------------|
| VD-04 | \$265.00 | Plate Evap, Horizontal and Vertical Installation, 3.9"D x 14.8"W x 10"H |
| VD-05 | \$265.00 | Plate Evap, Horizontal and Vertical Installation, 1"D x 14.8"W x 13.7" H |
| VD-18 | \$260.00 | Plate Evap, Rear Wall Installation |
| VD-08 | \$410.00 | Angle Evap, For Refrigerator or Freezer up to 2.5 cu.ft. |
| VD-09 | \$355.00 | Large-Sized Evap, Horizontal and Vertical Installation |
| VD-15 | \$530.00 | High-Performance Forced Air Evap.** |

Notes:

1. The VD-15 is suited for large cooling volumes and high ambient temperatures.
2. Comes with white plastic housing with brushless fan.

REFRIGERATION

Adler Barbour DIY Refrigeration

| Kits | | |
|-------------------------------------------------------------------------------------------------------------------------|-------------------------|-------------------------------------------------------------------------|
| Item No. | List Price (USD) | Description |
| CS-NC-15 | \$1,070.00 | Compact Compressor Cooling Kit |
| C8075 | \$195.00 | Booster Blow Duct Kit for CU-100 |
| C8071 | \$325.00 | Booster Blow Duct Kit for CU-200 |
| C8079 | \$195.00 | Vent Duct Kit for CU-100 |
| C8070 | \$195.00 | Vent Duct Kit for CU-200 |
| C8350 | \$750.00 | Cool Water Kit with 12V Pump for CU-200 |
| Accessories | | |
| 3123920 | \$55.00 | Coupling, QC, 3/8" Male, Size 4 |
| 3123930 | \$55.00 | Coupling, QC, 1/4" Female, Size 4 |
| 755570000 | \$210.00 | Adapter - One Shot for new QCs* |
| 4030002 | Call For Price | Z5006 Electronic Module, Standard |
| 4030003 | \$490.00 | Z5007 Electronic Module, Hard Start |
| 4030004 | \$295.00 | Electronic Module RFI |
| 758000005 | \$835.00 | AB3017, Electronic Module, 4 Pin, 12V Controller |
| C7210 | \$365.00 | Automatic Spill-Over Fan Kit, Analog |
| E1134 | \$110.00 | Mounting Bracket for CU-100 and CU-200 |
| F1701 | \$85.00 | Verticube Ice tray w/ Polygrid Inserts |
| 8141430 | \$8.66 | Z3301 Ice Tray - Horizontal |
| 8141431 | \$6.56 | Z3302 Polygrid for Verticube |
| 4060202 | \$31.00 | D8072 Thermostat Spill-Over, Yellow Dot |
| 4060203 | \$31.00 | E1391 Thermostat Powerplate/Freezer, White Dot |
| 4060204 | \$37.00 | Z3202 Thermostat Refrigerator, Blue Dot |
| 4030592 | \$75.00 | Z3281 Fan 12VDC, Condenser (CU-100 and CU-200) |
| 336567 | \$38.00 | Z5020 Fan 12VDC, Mini, Spillover |
| C1502JR1500 | \$165.00 | Thermostat Asm Analog, with 1500 Ohm Resistor (All VD's Freezer) |
| F1710JR270 | \$155.00 | T-stat Small Evap Asm Analog, with 270 Ohm Resistor (VD-150 and VD-151) |
| F1710JR680 | \$145.00 | Thermostat Large Evap Analog, w/680 Ohm Resistor (VD-152 and VD-153) |
| Z4071FJR1500 | \$450.00 | Digital T-Stat for VD-160 & 0^ plate |
| Z4071R | \$410.00 | Digital T-Stat for Refrigerator |
| Z4071F | \$410.00 | Digital T-Stat for Freezer |
| 4030011 | \$150.00 | F1886 PCB Stuffed (CU-100 and CU-200) |
| F1884 | \$500.00 | Replacement PCB Stuffed and Danfoss Module |
| 3011005 | \$585.00 | Compressor 12/24 Danfoss BD50F |
| 298001526 | \$300.00 | Replacement Module 101N0213 Standard |
| *Note: If buying a new evaporator with new QCs to use with an older condensing unit, you must purchase One-Shot Adapter | | |

REFRIGERATION

Adler Barbour DIY Refrigeration

PROPRIETARY NOTE: THE INFORMATION CONTAINED WITHIN THIS DOCUMENT IS THE PROPERTY OF DOMETIC CORPORATION. ANY ATTEMPT TO COPY OR DISTRIBUTE WITHOUT WRITTEN CONSENT FROM DOMETIC CORPORATION SHALL BE CONSIDERED UNLAWFUL AND CAN BE CONTESTED IN A COURT OF LAW.

| REV | DATE | REVISION DESCRIPTION | DWG | APR |
|-----|---------|------------------------------------------------------|-----|-----|
| A | 9/16/11 | REV BASE EVAP P/N, ADDED LINE LENGTH SPEC, CAD928-11 | DRR | DA |
| B | 11/1/11 | REVISED LINE LENGTH FROM IN TO FT, CAD1053-11 | DRR | DA |
| C | 4/9/12 | REVISED A+B & C+D+E DIMS, CAD208-12 | DRR | BJL |
| D | 1/22/14 | REPLACED DWG 8101308 WITH THIS DWG, CAD045-14 | DRR | BJL |

BASE EVAP: 8101308
30 LONG X 11 HIGH

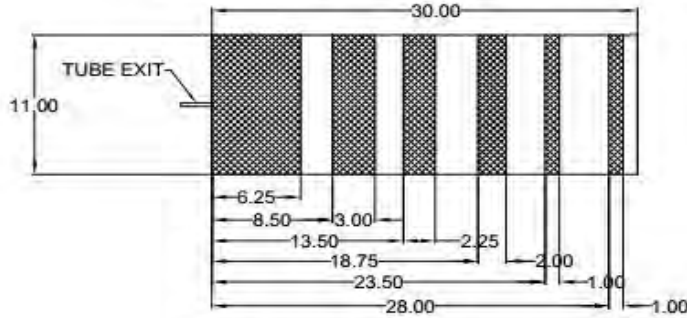

☒ HATCH AREAS = "NO BEND ZONES"

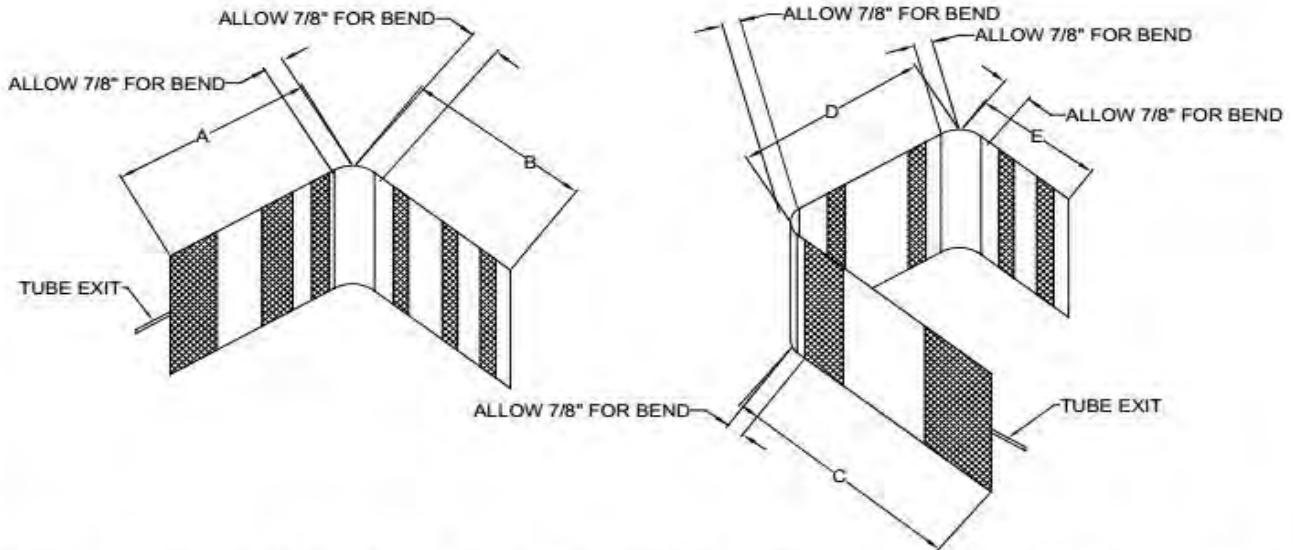

TYPICAL "L" SHAPED EVAP

A _____ +/- 3/8"

B _____ +/- 5/8"

A + B = 30.38"

LINE LENGTH FROM PLATE TO QD. (SPECIFY ONE)

7.50 FT

15.0 FT

TYPICAL "U" SHAPED EVAP

C _____ +/- 3/8"

D _____ +/- 3/8"

E _____ +/- 5/8"

C + D + E = 28.75"

TUBE EXIT _____ (TOP/BOTTOM)

ENTER "A" & "B" FOR L OR ENTER "C", "D", & "E" FOR U-SHAPED EVAPORATOR

SPECIFY TOP OR BOTTOM TUBE EXIT AND TUBE LENGTH

IF BENDS NEED TO BE IN A NO BEND ZONE
CONSULT FACTORY FIRST

| | | | |
|----------------------------------------------|-------------|------------------|--------------|
| DOMETIC | | | |
| CUSTOM EVAPORATOR WORK SHEET VD-150 PLATE | | | |
| DATE: 6/15/11 | DWG BY: DRR | PART NUMBER: N/A | DWG G6020026 |
| SCALE: NTS | APR BY: BJL | | REV D |

REFRIGERATION

Adler Barbour DIY Refrigeration

PROPRIETARY NOTE: THE INFORMATION CONTAINED WITHIN THIS DOCUMENT IS THE PROPERTY OF DOMETIC CORPORATION. ANY ATTEMPT TO COPY OR DISTRIBUTE WITHOUT WRITTEN CONSENT FROM DOMETIC CORPORATION SHALL BE CONSIDERED UNLAWFUL AND CAN BE CONTESTED IN A COURT OF LAW.

| REV | DATE | REVISION DESCRIPTION | DWG | APR |
|-----|---------|------------------------------------------------------|-----|-----|
| A | 9/16/11 | REV BASE EVAP P/N, ADDED LINE LENGTH SPEC, CAD929-11 | DRR | DA |
| B | 11/1/11 | REVISED LINE LENGTH FROM IN TO FT, CAD1053-11 | DRR | DA |
| C | 1/22/14 | REPLACED DWG 8101307 WITH THIS DWG, CAD044-14 | DRR | BJL |
| | | | | |
| | | | | |

BASE EVAP: 8101307
40.25 LONG X 11.80 HIGH

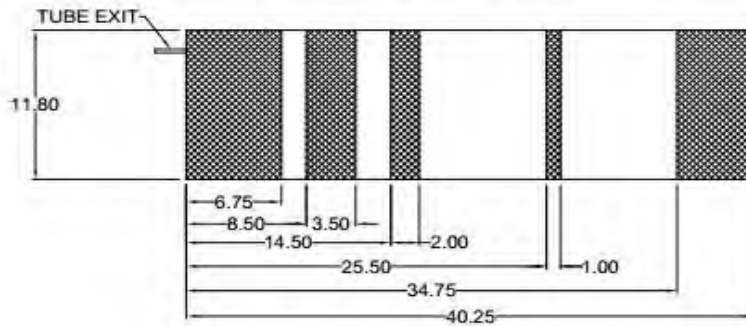

HATCH AREAS = "NO BEND ZONES"

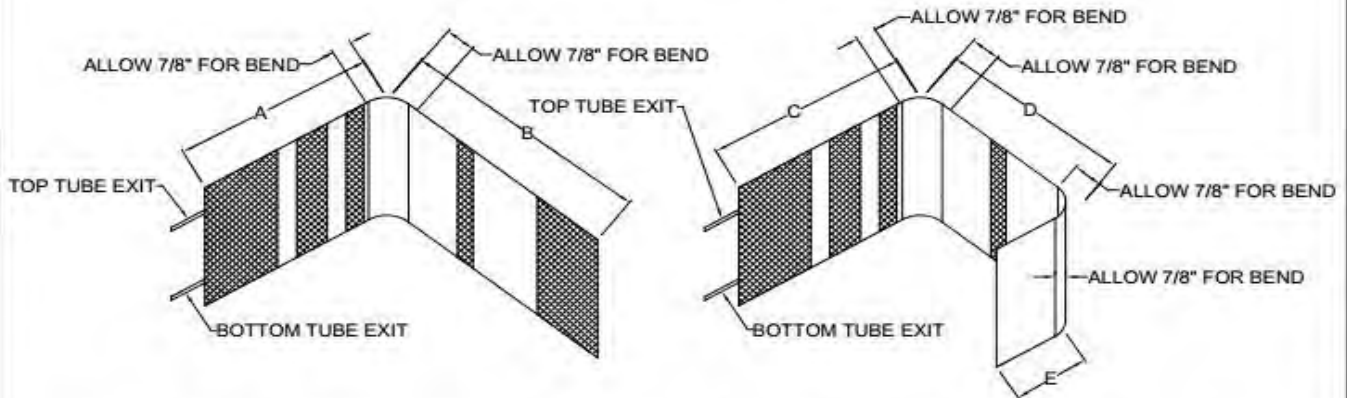

TYPICAL "L" SHAPED EVAP

A _____ +/- 3/8"

B _____ +/- 5/8"

A + B = 40.62"

LINE LENGTH FROM PLATE TO QD. (SPECIFY ONE)

7.50 FT

15.0 FT

TYPICAL "U" SHAPED EVAP

C _____ +/- 3/8"

D _____ +/- 3/8"

E _____ +/- 5/8"

C + D + E = 41"

TUBE EXIT _____ (TOP/BOTTOM)

ENTER "A" & "B" FOR L OR ENTER "C", "D", & "E" FOR U-SHAPED EVAPORATOR

SPECIFY TOP OR BOTTOM TUBE EXIT AND TUBE LENGTH

IF BENDS NEED TO BE IN A NO BEND ZONE
CONSULT FACTORY FIRST

| | | | |
|----------------------------------------------|-------------|--------------|-----------------|
| DOMETIC | | | |
| CUSTOM EVAPORATOR WORK SHEET VD-152 PLATE | | | |
| DATE: 6/15/11 | DWG BY: DRR | PART NUMBER: | DWG |
| SCALE: NTS | APR BY: BJL | N/A | G6020027 |
| | | | REV C |

REFRIGERATION

Eskimo Ice Makers, Accessories and Replacement Parts

Eskimo Ice Titanium Units with Digital Controls

| Item | List Price (USD) | Description | |
|------------------------------------------|------------------|------------------------------|-----------------------------------------------------------------------------------------------|
| EI1000X UNITS | | |  EI1000X |
| 252000063 | \$22,325.00 | EI1000X-230V Digital Control | |
| 252000053 | \$22,675.00 | EI1000X-220V Digital Control |  |
| EI540X UNITS | | | |
| 252000060 | \$13,725.00 | EI540X-115V Digital Control | |
| 252000061 | \$14,240.00 | EI540X-230V Digital Control | |
| 252000062 | \$14,225.00 | EI540X-220V Digital Control |  EI540X |
| HOSE KIT FOR EI1000X & EI540X | | | |
| 252000620 | \$425.00 | EI 35' Hose Kit | |
| 252000621 | \$215.00 | EI 15' Hose Kit | |
| PUMP KIT | | | |
| 252000571 | \$460.00 | EI540X-Pump Kit 220V 50-60 | |
| 252000572 | \$400.00 | EI540X-Pump Kit 115V/60 | |

Eskimo Ice Replacement Parts

| Item | List Price (USD) | Description |
|-----------|------------------|----------------------------------------------------------------|
| 4037069 | \$15.00 | Overload EI540 115V AKA9438ZXA |
| 4037072 | \$15.00 | Overload EI540 230V AKA9438ZXD |
| 336581 | \$130.00 | Relay Start EI1000 230V K71-16 |
| 4040060 | \$70.00 | Relay Start UMSR50 EI540 230V |
| 4037066 | \$215.00 | Relay Start EI540 Gear Motor 230V |
| 4037070 | Call For Price | Cap, Start 72-88MFD/330V EI540 230V/60/1 |
| 252000142 | \$2,445.00 | Replacement EI540D-115V Motor/Gear Box |
| 252000140 | \$2,895.00 | Replacement EI540D-230V Motor/Gear Box |
| 252000119 | \$325.00 | Replacement Water Reservoir w/digital Float |
| 252000136 | \$275.00 | Sensor Photo Diffuser EI540/EI1000 w/3POS Terminal Block Relay |
| 226000055 | \$13.00 | Hose 0.75" Clear PVC Reinforced |
| 226000056 | \$5.36 | Tube, Insulated 1.125ID x 0.75W |

Controls Digital

| Item No. | List Price (USD) | Description |
|-----------|------------------|--------------------------------------|
| 752000301 | \$1,235.00 | EIR600D 115/230 Complete Control Box |
| 252000150 | \$180.00 | Display, Digital |
| 4021100 | \$6.43 | Switch, Rocker Reset Button |
| 4021102 | \$7.50 | Cover, Rocker Switch Reset Button |

Circuit Boards for EI250D, EI540D and EI600D

| | | |
|-----------|----------|---------------------------------|
| 252000130 | \$660.00 | Circuit Board EI250D 115V/220V |
| 252000131 | \$690.00 | Circuit Board EI540D 115V/230V |
| 252000133 | \$690.00 | Circuit Board EI540D 220V 50Hz |
| 252000134 | \$690.00 | Circuit Board EI600D 115V/230V |
| 252000147 | \$690.00 | Circuit Board EI1000D 230/50-60 |

REFRIGERATION

Eskimo Ice Makers, Accessories and Replacement Parts

| Replacement Parts for 600 Series Units | | |
|-------------------------------------------------------|-------------------------|-----------------------------------------------------------------------------|
| Item No. | List Price (USD) | Description |
| 4050004 | \$20.00 | Spout Switch |
| 252000107 | \$65.00 | Repl Y-Strainer w/fittings - Digital and Mechanical |
| 252000118 | \$2,010.00 | Retrofit Kit to Upgrade to Digital |
| 252000200 | \$95.00 | Ice Thru Hull - Straight |
| 252000201 | \$505.00 | Condensate Pan - painted |
| 226000052 | \$7.53 | 1.25" Clear Vinyl Hose - Per Foot |
| 226000053 | \$5.36 | 1.625" white insulation for hose Per Foot 1/2" wall |
| 298001414 | \$1,010.00 | Condenser Coil - Painted, EI600D |
| 333360 | \$19.00 | Auger Motor Run Cap Fits 115 volt and 230 volt |
| 4037000 | \$90.00 | Top Upper Bearing |
| 4037001 | \$75.00 | Bottom Lower Bearing |
| 4037003 | \$34.00 | Spout gasket |
| 4037012 | \$165.00 | Coupling, EI600 Digital and Mechanical |
| 4037013 | \$480.00 | Water Seal (2 parts) Digital and Mechanical |
| 4037020 | \$20.00 | Auger motor bearing Digital and Mechanical |
| 4037028 | \$5.47 | Woodruff Key Digital and Mechanical |
| 3150309 | \$285.00 | Water Filter Assembly |
| 3150310 | \$235.00 | Replacement Filter (2 per pack) |
| 252000104 | \$180.00 | Repl Water Reservoir w/90° Elbow EI600 Digital and Mechanical |
| REMOTE SYSTEMS | | |
| Auger Units | | |
| 4030200 | \$2,740.00 | Auger Motor - 115V Digital and Mechanical |
| 4030201 | \$2,850.00 | Auger Motor - 230V Digital and Mechanical |
| 4020010 | \$45.00 | Switch, float single stage vertical mount |
| 752000010 | \$290.00 | Photo Electric Eye Digital |
| Condensing Units EI600 | | |
| 252000126 | \$1,625.00 | EI600 Compressor - painted, 230V |
| 252000128 | \$2,325.00 | Replaces 297600697 (not a direct drop in) EI600D Compressor - painted, 115V |
| 4024212 | \$47.00 | EI600 Low Pressure Switch |
| 4024302 | \$29.00 | EI600 High Pressure Switch |
| 4040019 | \$80.00 | EI600 Start Relay, 230V |
| 4040023 | \$65.00 | EI600 Start Capacitor, 230V |
| 4040024 | \$41.00 | EI600 Start Relay, 115V |
| 4040025 | \$40.00 | EI600 Start Capacitor, 115V |
| 4040115 | \$17.00 | EIR600 Run Capacitor, 115V |
| 4043102 | \$49.00 | EI600 Overload, 230V |
| SELF CONTAINED MECHANICAL SYSTEMS WITH CAPTUBE | | |
| Item No. | List Price (USD) | Description |
| 4020003 | \$190.00 | Spout Switch Button 15A 12/250V |
| 4020004 | \$80.00 | Water Pressure Switch |
| 4020005 | \$16.00 | Water Pressure Switch Cover - Red Vinyl |
| 4062305 | \$85.00 | Sensor for Temp Control (ETC) 10' |
| 259200301 | \$355.00 | Temp Control Assembly |
| 225500226 | \$420.00 | Pump Asy PML250 115V No Fittings |
| 225500227 | \$430.00 | Pump Asy PML250C 230V No Fittings |

GALLEY PRODUCTS

Refrigerators and Freezers

Eskimo Cup Cooler

| Item | List Price (USD) | Model |
|-----------|------------------|----------------------------------------|
| 250140101 | \$99.50 | Eskimo Cup Cooler 12VDC w/SS Trim Ring |



CRX Door Refrigerator/Freezers

| Item | List Price (USD) | Model | Description |
|--------------------------------------------------------------------------------------------------------------------|------------------|------------------------------|------------------------|
| STAINLESS STEEL DOORS FULL STAINLESS WRAPPED DOORS W/O MOUNT FLANGES | | | |
| 75502.307.00 | \$1,085.00 | CRX-1050S 1.7CF AC/DC SS | 50 liter SS |
| 75502.307.20 | \$1,155.00 | CRX-1065S 2.3CF AC/DC SS | 65 liter SS |
| 75502.307.40 | \$1,355.00 | CRX-1080S 2.8CF AC/DC SS | 80 liter SS |
| 75502.307.60 | \$1,490.00 | CRX-1110S 3.8CF AC/DC SS | 110 liter SS |
| 75502.307.100 | Call for Price | CRX-1140S 4.2CF AC/DC SS | 140 liter SS |
| BLACK DOOR PANEL (U) AND BLACK SURROUND WITH BLACK (F) FLUSH MOUNT | | | |
| 75502.010.01 | \$1,060.00 | CRX-1050U/F,1.7CF,AC/DC | 50 liter black flush |
| 75502.010.20 | \$1,105.00 | CRX-1065U/F,2.3CF,AC/DC | 65 liter black flush |
| 75502.010.40 | \$1,275.00 | CRX-1080U/F 2.8CF AC/DC | 80 liter black flush |
| 75502.010.60 | \$1,335.00 | CRX-1110U/F,3.8CF,AC/DC | 110 liter black flush |
| BLACK DOOR PANEL (U) AND BLACK SURROUND WITH BLACK (S) SPACE SAVER FRAME | | | |
| 75502.030.00 | \$1,030.00 | CRX-1050U/S 1.7CF AC/DC | 50 liter black space |
| 75502.030.20 | \$1,075.00 | CRX-1065U/S 2.3CF AC/DC | 65 liter black space |
| 75502.030.60 | \$1,365.00 | CRX-1110U/S 3.8CF AC/DC | 110 liter black space |
| SILVER DOOR PANEL (S) AND SILVER SURROUND WITH SILVER (F) FLUSH MOUNT | | | |
| 75502.145.01 | \$1,050.00 | CRX-1050E/F-S,1.7CF,AC/DC | 50 liter silver flush |
| 75502.145.20 | \$1,085.00 | CRX-1065E/F-S,2.3CF,AC/DC | 65 liter silver flush |
| 75502.145.40 | \$1,265.00 | CRX-1080E/F-S 2.8CF AC/DC | 80 liter silver flush |
| 75502.145.60 | \$1,375.00 | CRX-1110E/F-S 3.8CF AC/DC | 110 liter silver flush |
| SILVER DOOR PANEL (S) AND SILVER SURROUND WITH SILVER (S) SPACE SAVER FRAME | | | |
| 75502.165.00 | \$1,200.00 | CRX-1050E/S-S 1.7CF AC/DC DC | 50 liter silver space |
| 75502.165.60 | \$1,480.00 | CRX-1110E/S-S 3.8CF AC/DC | 110 liter silver space |
| CHROME PLASTIC DOOR (CR) WITH SILVER SURROUND WITH SILVER (F) FLUSH MOUNT FRAME | | | |
| CR-1140ST-D65-A | \$1,505.00 | CR-1140 AC/DC REFRIGERATOR | 140 liter chrome |
| WHITE DOOR PANEL AND SILVER SURROUND AND SILVER (F) FLUSH MOUNT FLANGES (designed for cockpit locations) | | | |
| 75502.144.00 | \$1,095.00 | CRX-1050E/F-W 1.7CF AC/DC | 50 liter white |
| 75502.144.20 | \$1,135.00 | CRX-1065E/F-W 2.3CF AC/DC | 60 liter white |

CRX



CRD



GALLEY PRODUCTS

Refrigerators and Freezers

| CRD Drawer Refrigerators/Freezers | | | | |
|-------------------------------------------------------------------------------------------------------------------------------------|------------------|--------------------------------------|---------------------------------------------------------------------------------------|-------------|
| Item | List Price (USD) | Model | Description | |
| STAINLESS STEEL DRAWER (SS) FULL STAINLESS WRAPPED PULL OUT DRAWER, W/O MOUNT FLANGE (see below for desired mount flange) | | | | |
| 74922.307.00 | \$1,490.00 | CRD-1050S 1.7CF AC/DC SS DRAWER | 50 liter SS | |
| BLACK DOOR PANEL DRAWER (U) W/O MOUNT FLANGE (see below for desired mount flange) | | | | |
| 74922.000.00 | \$1,315.00 | CRD-1050U 1.7CF AC/DC DRAWER | 50 liter black | |
| SILVER DOOR PANEL DRAWER (E) W/O MOUNT FLANGE (see below for desired mount flange) | | | | |
| 74922.101.00 | \$1,340.00 | CRD-1050E 1.7CF AC/DC DRAWER | 50 liter silver | |
| CRX/CR/CRD Mount Flanges for Stainless Steel, Black and Silver Door Refrigerators/Freezers | | | | |
| Item | List Price (USD) | Model | Finish | Flange |
| EFM-0050S | \$115.00 | FRAME, CR50 | STAINLESS | FLUSH MOUNT |
| EFM-0065S | \$110.00 | FRAME, CR65 | STAINLESS | FLUSH MOUNT |
| EFM-0080S | \$140.00 | FRAME, CR80 | STAINLESS | FLUSH MOUNT |
| EFM-0110S | \$140.00 | FRAME, CR110 | STAINLESS | FLUSH MOUNT |
| EFM-0140S | \$140.00 | FRAME, CR140 | STAINLESS | FLUSH MOUNT |
| EFM-0050SBD65A | \$90.00 | FRAME, CR(X)50 | BLACK | FLUSH MOUNT |
| EFM-0050U | \$90.00 | FRAME, CR50 | BLACK | FLUSH MOUNT |
| EFM-0065SBD65A | \$90.00 | FRAME, CR(X)65 | BLACK | FLUSH MOUNT |
| EFM-0065U | \$90.00 | FRAME, CR65 | BLACK | FLUSH MOUNT |
| EFM-0080U | \$100.00 | FRAME, CR80 | BLACK | FLUSH MOUNT |
| EFM-0110U | \$110.00 | FRAME, CR110 | BLACK | FLUSH MOUNT |
| EFM-0050SGD65A | \$85.00 | FRAME, CR(X)50 | SILVER | FLUSH MOUNT |
| EFM-0050E | \$85.00 | FRAME, CR50 | SILVER | FLUSH MOUNT |
| EFM-0065SGD65A | \$90.00 | FRAME, CR(X)65 | SILVER | FLUSH MOUNT |
| EFM-0065E | \$90.00 | FRAME, CR65 | SILVER | FLUSH MOUNT |
| EFM-0110SBD65A | \$110.00 | FRAME, CR(X)110 | SILVER | FLUSH MOUNT |
| EFM-0110E | \$110.00 | FRAME, CR110 | SILVER | FLUSH MOUNT |
| EST-0050S | \$110.00 | FRAME, CR50 | STAINLESS | SPACE SAVER |
| EST-0065S | \$115.00 | FRAME, CR65 | STAINLESS | SPACE SAVER |
| EST-0080S | \$135.00 | FRAME, CR80 | STAINLESS | SPACE SAVER |
| EST-0110S | \$135.00 | FRAME, CR110 | STAINLESS | SPACE SAVER |
| EST-0140S | \$135.00 | FRAME, CR140 | STAINLESS | SPACE SAVER |
| EST-0050SWD65A | \$80.00 | FRAME, CR(X)50 | WHITE | SPACE SAVER |
| EST-0050SBD65A | \$80.00 | FRAME, CR(X)50 | BLACK | SPACE SAVER |
| EST-0050U | \$80.00 | FRAME, CR50 | BLACK | SPACE SAVER |
| EST-0065SBD65A | \$80.00 | FRAME, CR(X)65 | BLACK | SPACE SAVER |
| EST-0065U | \$80.00 | FRAME, CR65 | BLACK | SPACE SAVER |
| EST-0080SBD65A | \$90.00 | FRAME, CR(X)80 | BLACK | SPACE SAVER |
| EST-0080U | \$90.00 | FRAME, CR80 | BLACK | SPACE SAVER |
| EST-0110SBD65A | \$100.00 | FRAME, CR(X)110 | BLACK | SPACE SAVER |
| EST-0110U | \$100.00 | FRAME, CR110 | BLACK | SPACE SAVER |
| EST-0050E | \$80.00 | FRAME, CR50 | SILVER | SPACE SAVER |
| EST-0065E | \$85.00 | FRAME, CR65 | SILVER | SPACE SAVER |
| EST-0080E | \$90.00 | FRAME, CR80 | SILVER | SPACE SAVER |
| EST-0110E | \$100.00 | FRAME, CR110 | SILVER | SPACE SAVER |
| CD Drawer Refrigerators | | | | |
| CD20-DCB-D65-B | \$800.00 | CD-020 0.75CF 12V DC ONLY BLACK |  | |
| CD20-DCW-D65-B | \$800.00 | CD-020 0.75CF 12V DC ONLY WHITE | | |
| CD-030-D65-C | \$800.00 | CD-030 1.1CF 12/24VOLT DC ONLY BLACK | | |
| CD-030DCW-D65A | \$825.00 | CD-030 1.1CF 12/24VOLT DC ONLY WHITE | | |
| CD Drawer Mount Flanges | | | | |
| 291606073 | \$125.00 | FRAME, CD030 DRAWER SS | FLUSH MOUNT | |
| EST-0500 | \$65.00 | FRAME, CD030 DRAWER BLACK | FLUSH MOUNT | |
| EST-0500W | \$65.00 | FRAME, CD030 DRAWER WHITE | FLUSH MOUNT | |

GALLEY PRODUCTS

Refrigerators and Freezers

CB Built-In Refrigerators/Freezers Top Load

| | | |
|----------|------------|--------------------------------|
| CB-036 | \$1,115.00 | CB-036 1.3CF 12/24VOLT DC ONLY |
| CB-036AC | \$1,475.00 | CB-036 1.3CF AC/DC |
| CB-040 | \$1,130.00 | CB-040 1.4CF 12/2VOLT DC ONLY |
| CB-040AC | \$1,190.00 | CB-040 1.4CF AC/DC |



CF Portable Refrigerators/Freezers

| Item | List Price (USD) | Description |
|----------------|------------------|-------------------------------|
| CF-018-D65-B | \$545.00 | CF-018DC 0.7CF 12/24V DC ONLY |
| CF-25DC-D65-B | \$645.00 | CF-025DC 0.9CF 12/24V DC ONLY |
| CF-50-DC-D65-B | \$835.00 | CF-050DC 1.7CF 12/24V DC ONLY |
| CF-035AC110 | \$820.00 | CF-035AC110 1.1CF AC/DC |
| CF-040AC110 | \$895.00 | CF-040AC110 1.3CF AC/DC |
| CF-050AC110 | \$1,005.00 | CF-050AC110 1.7CF AC/DC |
| CF-080AC110 | \$1,185.00 | CF-080AC110 2.8CF AC/DC |
| CF-110AC110 | \$1,265.00 | CF-110AC110 3.77CF AC/DC |



Power Supplies

| | | |
|---------------|----------|-------------------------------------------|
| MPS-35 | \$105.00 | AC Adapter, for "CR," "CB," & "CD" models |
| MPS-50 | \$105.00 | AC Adapter for "CF" models |
| SP-065PCBASE | \$6.81 | Voltage Regulator for CR Series |
| 37-T2-0530ED | \$6.56 | DC Power Cord for CR Series |
| 80-T2-2000AI1 | \$27.00 | DC Cord, CF-18/80/110 |
| 80-T2-2000AG1 | \$35.00 | DC Cord, CF-25/35/40/50 |
| 38-UL-2000B6 | \$25.00 | AC Cord, CF-35/40/50/80/110 |
| 70-CB-06B32 | \$1.06 | Cord Clamp, All CR Series |

Replacement Parts for Refrigerators

Module

| | | |
|------------|----------|-----------------------------------------------|
| 4441000039 | \$385.00 | Module 101N0500 (AC/DC) CR & CF Units |
| 298001526 | \$300.00 | Module 101N0213 STD Marine Only CR & CF Units |

Digital Temp Display AC/DC units use 4441000039

Note: There was a change in CF displays in June 2009. Older units had an LED temperature display.

Newer units have Digital temperature displays. Dataplates for Newer units will indicate whether the unit is a Version A or Version B.



Thermostat

| | | |
|-------------|---------|------------------------|
| 13-00-KPF1E | \$38.00 | Thermostat CR Series |
| 4450001983 | \$3.00 | Thermistors for all CF |

Light

| | | |
|---------------|---------|---------------------------------------------------------------------|
| 18-W3-122401B | \$32.00 | LED Light CR Series |
| 4441600017 | \$27.00 | Light Voltage Regulator with Bulb - old style CR Units and R Series |

Fan

| | | |
|----------------|---------|---------------------------|
| 11-01-D90BL12A | \$46.00 | Fan CR-50-65 |
| 11-00-D12SM12 | \$46.00 | Fan, CF-80/110, CR-80/110 |
| 018FANASA | \$35.00 | Fan Assembly, CF-25 |

Gasket

| | | |
|----------------|---------|---------------|
| 42-065-065GS01 | \$19.00 | Gasket CR-50 |
| 42-090-090GS01 | \$19.00 | Gasket CR-65 |
| 42-091-091GS01 | \$29.00 | Gasket CR-80 |
| 42-092-092GS01 | \$30.00 | Gasket CR-110 |

GALLEY PRODUCTS

Refrigerators and Freezers

Refrigerator Replacement Parts Continued

| Item | List Price (USD) | Description |
|--------------------------------------------------|------------------|-------------------------------------|
| Water Pan | | |
| 4450007376 | \$14.00 | Water Pan CR-50 |
| 40-090-11PT6C7 | \$14.00 | Water Pan CR-65 |
| 40-091-11PT6C7 | \$14.00 | Water Pan CR-80 |
| Door, Cover and Hinge Assemblies | | |
| SP022COVERAS1 | \$65.00 | Cover Assembly CF-18 |
| SP065FREDOORASA | \$22.00 | Freezer Door Assembly CR-50 |
| SP090FREDOORASA | \$26.00 | Freezer Door Assembly CR-65 |
| SD065COMDOORASA | \$320.00 | Door Assembly, Black on Black CR-50 |
| SD090COMDOORASA | \$350.00 | Door Assembly, Black CR-65 |
| SD090COMDOORASB | \$295.00 | Door Assembly, Silver CR-65 |
| SD091COMDOORASA | \$330.00 | Door Assembly, Black CR-80 |
| SD092COMDOORASA | \$345.00 | Door Assembly, Black CR-110 |
| 46-065-08BX | \$28.00 | Hinge for CR Series |
| SP028HINGEASA | \$30.00 | Hinge Assembly, CF-80/110 |
| Inner Layer for CR-65 & 80 | | |
| 40-090-08PT6C7 | \$17.00 | Inner Layer for Fridge CR-65 |
| 40-091-08PT6C7 | \$17.00 | Inner Layer for Fridge CR-80 |
| Mounting Kit | | |
| UFK-C | \$85.00 | Mounting Kit for CF-25, 35, 40, 50 |
| Light, Latch, Handle & Lid Assemblies | | |
| 81-01-980LGT | \$15.00 | DC Light Assembly, CF-25/50DC |
| 81-01-026LGT | \$16.00 | DC Light Assembly, CF-35DC |
| 81-01-026LGT1 | \$17.00 | AC/DC Light Assembly, CF35/40 |
| 4451037806 | \$18.00 | AC/DC Light Assembly, CF-50/80/110 |
| SP026LOCKINGASA | \$26.00 | Latch Assembly, CF-35/40 |
| SP028LOCKASA | \$17.00 | Latch Assembly, CF-80/110 |
| SP026LIDASC | \$65.00 | Lid Assembly, CF-35/40 |
| SP005COVERASC | \$175.00 | Lid Assembly, CF-50 |
| SP028COVERD65A | \$130.00 | Lid Assembly, CF-80/110 |
| SP005HANDLEASA | \$60.00 | Handle Assembly, CF-50 |
| SP028HANDLEASA | \$50.00 | Handle Assembly, CF-80/110 |
| Basket for CF Series | | |
| 46-026-05TSW | \$32.00 | Basket, CF-35 |
| 46-026-04TSW | \$32.00 | Basket, CF-40 |
| 46-005-04TSW01 | \$29.00 | Basket, CF-50 |
| 46-028-32TSW | \$24.00 | Basket, CF-80 |
| 46-028-28TSW | \$70.00 | Basket, CF-110 |
| Protective Covers | | |
| IC-CF-18 | \$75.00 | Cover for CF-018 |
| IC-CF-25 | \$55.00 | Cover for CF-025 |
| IC-CF-35 | \$70.00 | Cover for CF-035 |
| IC-CF-40 | \$70.00 | Cover for CF-040 |
| IC-CF-50 | \$80.00 | Cover for CF-050 |
| IC-CF-80 | \$120.00 | Cover for CF-080 |
| IC-CF-110 | \$120.00 | Cover for CF-110 |



GALLEY PRODUCTS

Refrigerators and Freezers

| Refrigerator Replacement Parts For R Series | | |
|----------------------------------------------------|-------------------------|---------------------------------------------|
| Item | List Price (USD) | Description |
| <u>RPD SERIES</u> | | |
| 4441100007 | \$44.00 | Thermostat for RPD-50/65/80/110 |
| 4441100034 | \$32.00 | Thermostat, RSF-115 |
| 120340/0 | \$75.00 | Evaporator Flap for RPD-110 |
| 2076147012 | \$46.00 | Evaporator Frame for RPD-110 |
| 4443000089 | \$38.00 | Drip Bowl for RPD-110 |
| EST-0100 | \$75.00 | Standard Flange, RPD-50 |
| EST-0300 | \$85.00 | Standard Flange, RPD-80, RSA-80 |
| EST-0400 | \$85.00 | Standard Flange, RPD/RSA-110, RSD/RSF-115 |
| EFM-0100 | \$165.00 | Flush Mount Frame, RPD-50 |
| EFM-0200 | \$130.00 | Flush Mount Frame, RPD-65, RSA-60, RPF-50 |
| EFM-0300 | \$180.00 | Flush Mount Frame, RPD-80, RSA-80 |
| EFM-0400 | \$135.00 | Flush Mount Frame, RPD/RSA-110, RSD/RSF-115 |

GALLEY PRODUCTS

Origo Cooktops and Ovens

| Origo Galley Products | | |
|------------------------------|-------------------------|----------------------------------------------|
| Item Number | List Price (USD) | Description |
| Alcohol Stoves | | |
| 9581401-99 | \$320.00 | US/C A-Stove 1500 |
| 9581409-99 | \$455.00 | US/C A-Stove 2000 CB |
| 9581405-99 | \$450.00 | US/C A-Stove 3000 - free standing |
| 9581415-99 | \$555.00 | US/C A-Stove 4100 CB |
| 958147001 | \$525.00 | A100 GL Single burner alcohol with glass lid |
| Ovens | | |
| 9581450-99 | \$2,125.00 | US/C Oven 6000 |

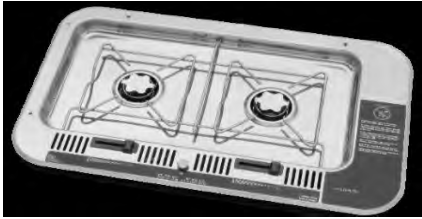
| | | |
|------------------------------------------------------------------------------------|------------------------------------------------------------------------------------|--------------------------------------------------------------------------------------|
|  |  |  |
| 1500 | 4100 | 6000 |
|  |  |  |
| 2000 | HEAT PAL 5100 | 3000 |

| Accessories | | |
|--------------------|----------|-------------------------------------------------------------|
| 9581442-99 | \$245.00 | US/C Heat Pal 5100 |
| 9581482-01 | \$125.00 | Gimbal 3002 |
| 9581480-01 | \$65.00 | Potholder 3001 fits models 1500,3000 & 6000 |
| 9581481-01 | \$75.00 | Potholder 4001 fits models 4000, 4100, 2500E & 4300E |
| 3880009-80 | \$105.00 | Fuel container Complete for all stoves except 5100 Heat Pal |
| 3880009-81 | \$160.00 | Fuel container 5100 |
| 3880028-80 | \$39.00 | Knob + Label for 1500/3000/6000 |
| 3880036-00 | \$18.00 | Rubber gasket |
| 3880068-01 | \$165.00 | Cutting board 4100 |
| 3880082-70 | \$310.00 | Cutting board 4300 complete |
| 3880154-00 | \$120.00 | Cutting board 2000 |
| 3880162-00 | \$29.00 | Flame spreader |
| 3880253-82 | \$325.00 | Glass lid black 4100/4300 |
| 3880253-83 | \$285.00 | Glass lid black 2000/2500 |
| 3880271-81 | \$44.00 | Slide control al. Complete |
| 3886023-30 | \$7.43 | Bumper SJ 5027 PC Board Spacer |
| 3880183-10 | \$265.00 | Burner element 120 volt, 2500E/4300E |

Product Cancellation Policy

Dometic manufactures a broad range of products that are made available to our extensive customer base in two distinct categories:

1. The Majority of our sales volume is derived from products that are ordered on a consistent basis and therefore are placed into our Stocking Profile Matrix (SPM). These items are classified as Standard/Stock because we generally have multiple customers for like items and we produce these products on a continuous basis.
2. We also offer for sale, a wide variety of products that do not meet the criteria for SPM but we have established part numbers along with current pricing for them. These products are manufactured as the result of a specific customer's request and are only built to order. To distinguish between SPM products and these products, we classify them in our computer system as Active Special Order. So that we continue to meet the demands of all customers and stay flexible with our manufacturing mix, these products are only built to order.

In order to ensure that we make the best use of our resources, we find it necessary to establish a firm order cancellation policy and in some cases request a deposit before an order is started in manufacturing.

Any product ordered that is categorized as "active special order" will be considered non-cancellable. In addition, we reserve the right to request a deposit on any order that contains items that are designated as "active special order". The status of all parts can be viewed on the E-Dometic website at anytime.

How does this work? Once the order is acknowledged, a deposit is received (if requested) and the parts ordering/manufacturing process is started, these items are non-cancellable.

An exception to the above is the process of Custom Wood Grilles and Custom Plenums. These items can be cancelled up to 5 business days prior to scheduled ship date.

Definitions:

1. **Stocking Profile (A)** Products that are regularly sold and have activity at least 8 of the last 12 months and sold to multiple customers.
2. **Active Special (AS)** All items sold or used less than 7 out of the last 12 months or sold only to a single customer.
3. **Obsolete (K)** Items with no history in the past eighteen months.

All order confirmations clearly indicate if an item ordered is a special order. If you buy direct from Dometic you have access to our E-Dometic site that shows the status of all parts. If you purchase through a dealer or Distributor please contact them in advance of placing your order if you are uncertain about the status of the part you are ordering and have them confirm the status for you.



2000 N. Andrews Ave.

Pompano Beach, FL 33069 USA

Phone 954-973-2477

Fax 954-979-4414

For sales and service within Europe and the Middle East, please call +44 870-330-6101

marinesales@dometic.com

dometic.com

L-3898

Effective 01-09-2017